

SKILL[®]

Surgical Instruments

EAR, NOSE AND THROAT INSTRUMENTS





SKILL® The World's Best Surgical Instruments

All **SKILL®** Instruments are manufactured on a three-pillar principle, namely raw material quality, skilled craftsmanship as well as precise and validated heat treatment and tempering.

Our goal is achieved by using German Forgings and German Steel for the production of our **SKILL®** Instruments. Using only German Craftsmanship, engineering and know-how throughout the manufacturing process along with the validated heat treatment is a necessity in the production of our **SKILL®** Instruments.

SKILL® Instruments are manufactured in Germany according to the EU Directive 93/42/EWG, as well as the following ISO Standards;

ISO: 9001
ISO:13458
ISO: 7153-1

No compromise is made on the quality of a **SKILL®** Surgical Instrument. The **SKILL®** short chain of supply allows clients to purchase the highest quality of Instrument at the most competitive pricing.

SKILL® Instruments offer the Surgeon a heightened sense of Instrument control allowing the Surgeon to greatly reduce the trauma and risk associated with Surgery.

OPERATE WITH SKILL®, OPERATE WITH US.

SKILL® Instruments carry a Lifetime warranty which covers any material defect or faulty manufacturing.

SKILL® Instruments will be repaired or replaced free of charge without compromise to the product in the event of a valid claim.

SKILL® Instruments are to be returned to the authorised distributor for maintenance, any work carried out by an unauthorised person will void the warranty.

No part of the Catalogue may be copied, forwarded or distributed without the express written consent given by the Manufacturer or its Distributor.

Operate with 

Table of Content | Chapter**Endoscopes, Endoscopic Cameras, Cold Light Sources****5****Otology****27****Sinus Surgery****97****Rhinology and Rhinoplasty****155****Nasopharynx and Oral Cavity****232****Larynx, Micro-Laryngology****285****General ENT Instruments****319**

Our Product Range



SURGERY



General Surgery



Dental Instruments



ENT Instruments



Sterilization Container



Micro Surgery



Electrosurgery

ENDOSCOPY



Endoscopic Devices



Endoscopes



Laparoscopy



Endoscopic Urology



Endoscopic Gynaecology



Arthroscopy

OR-EQUIPMENT



Operating Lights



Examination Lights



Operating Tables



Accessories for OR-Tables



Intensive Care Unit Beds



Head Rest System



Endoscopes, Endoscopic Cameras, Cold Light Sources



Table of Content | Chapter











| Product group | Page |
|--|-----------|
|  4K UHD Endoscopes | 8 |
| <hr style="border-top: 1px dotted black;"/> | |
|  Otosopes | 11 |
| <hr style="border-top: 1px dotted black;"/> | |
|  Laryngoscopes | 12 |
| <hr style="border-top: 1px dotted black;"/> | |
|  Bronchoscopes | 13 |
| <hr style="border-top: 1px dotted black;"/> | |
|  Flexible Naso-Pharyngo-/ Laryngofibrescopes | 14 |
| <hr style="border-top: 1px dotted black;"/> | |
|  Scope Containers, Endoscopy Baskets | 16 |
| <hr style="border-top: 1px dotted black;"/> | |
|  Steribox® for Endoscopes | 17 |
| <hr style="border-top: 1px dotted black;"/> | |

Table of Content | Chapter



| Product group | Page |
|---|--|
|  | <p>Miscellaneous Accessories</p> <p style="text-align: right;">18</p> |
| <hr style="border-top: 1px dotted black;"/> | |
|  | <p>1 CCD HD Cameras</p> <p style="text-align: right;">20</p> |
| <hr style="border-top: 1px dotted black;"/> | |
|  | <p>Objectives for Cameras, Soakable</p> <p style="text-align: right;">22</p> |
| <hr style="border-top: 1px dotted black;"/> | |
|  | <p>LED Cold Light Source</p> <p style="text-align: right;">23</p> |
| <hr style="border-top: 1px dotted black;"/> | |
|  | <p>Cold Light Cables and Adapters</p> <p style="text-align: right;">24</p> |
| <hr style="border-top: 1px dotted black;"/> | |
|  | <p>LED Cold Light Source</p> <p style="text-align: right;">26</p> |
| <hr style="border-top: 1px dotted black;"/> | |

4K UHD Endoscopes

Technical Information:

- Special calculated optical system, based on highly refractive rod lenses and newest coating technology, guarantees an excellent picture sharpness and color reproduction.
- High performance glass fibers, individually selected according to the application, perform an outstanding light transmission. Laser welded casing (fiber) shoe allows an optimal adjustment of fiber cutting surface to the angle of view of the endoscope = homogenous and shadow-free illumination of the operating area.
- The use of high-quality and non-corrosive medical stainless steel in combination with state of the art laser welding technology are the solid base for a long-live cycle of the endoscope.
- Scratch resistant sapphire glasses on distal and proximal side are gold induction soldered and assure an absolute tightness of the optical system.
- All endoscopes and its components are serially tested for absolute tightness by an in-house developed Helium testing procedure.
- Processing:
 - Fully autoclavable at 134°C / 273°F up to 18 minutes
 - Approved for STERRAD® 100/200™, STERRAD® NX™ and STERIS (according to instruction manuals of corresponding manufacturers)

- 1 Gold induction soldered sapphire objective window or negative
- 2 Fiber optic with laser welded fiber shoe for optimal alignment of illumination fibers
- 3 Special calculated rod lens system
- 4 Stainless steel construction
- 5 Special corrosion free compression tightening technology
- 6 Gold induction soldered sapphire glass
- 7 Fiber optic is completely sealed against the optical system

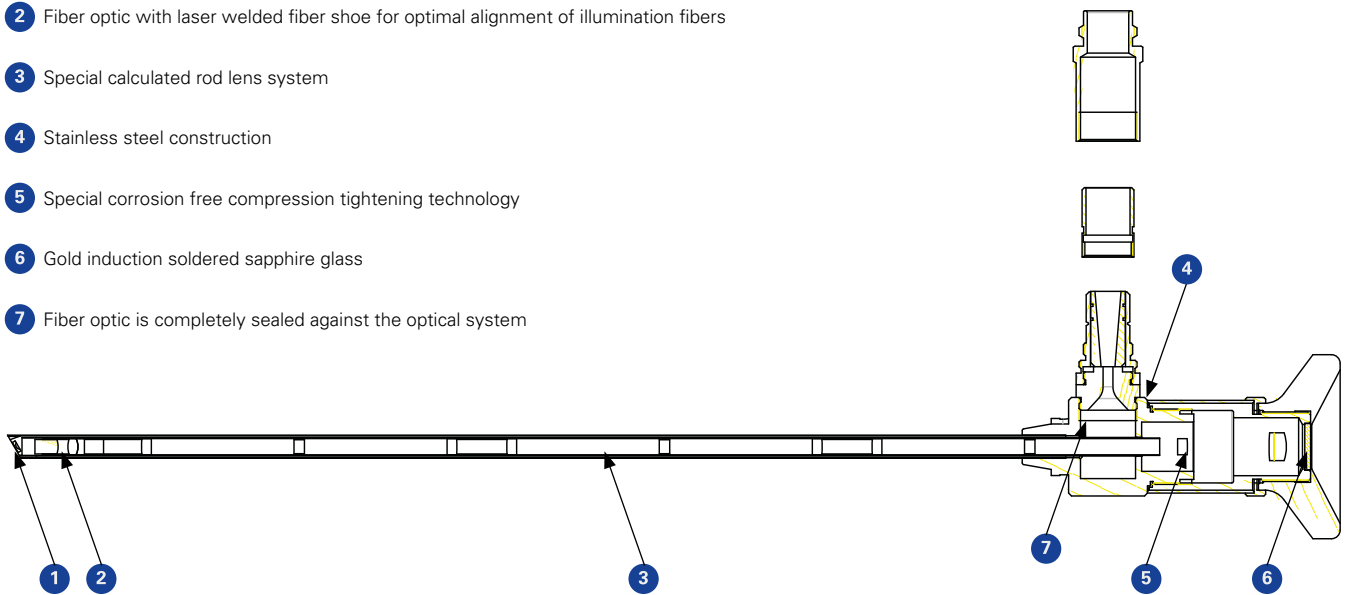

Compatibility

All SKILL endoscopes are equipped as standard with compatible light guide adapters for all common cold light cables.

SKILL | KARL STORZ | OLYMPUS



RICHARD WOLF



ACMI



4K UHD Endoscopes

Explanation Full HD | 4K

By the use of high-definition cameras in the endoscopy field, the resolution enlarges by 5 times, from 752 x 582 pixel (standard definition = SD) to 1920 x 1080 pixels (FULL HD), i. e. more than 2 million usable pixels, which results in a brilliant image quality and a higher level of detail. The new development of 4K UHD resolution of 3840 x 2160 pixels quadruples the the previous HD format and raises image quality to a new dimension. The SKILL 4K UHD camera is able to display the extended color space BT. 2020. This color space represents a much larger part of the spectrum perceptible to humans, while at the same time increasing color saturation (HD = BT. 709-5)

In combination with a 16:9 Wide screen HD 4K monitor, the user gets a natural panoramic view which is less fatigue than a picture in a square 4:3 format as the wider picture rather corresponds to the natural field of vision of humans. Thanks to this wide screen picture, an extended field of view is displayed and used instruments are faster visible in the lateral areas.

The increased picture information and contrast additionally enhance the three-dimensionality and depth perception of the picture which facilitates the orientation and the instrument handling inside the body as well as the diagnostic precision due to the fact that even finest structures such as tissue layers, blood vessels and nerve fibers are shown true to life in their different color nuances.

Due to the fact that a chain, in this case the optical chain consisting of endoscope, objective, light source, light cable, camera and monitor, is only as strong as its weakest link, all used components must support the HD | 4K UHD high resolution of the camera. Consequentially, AMNOTEC has equipped all standard endoscopes with a new calculated optical system based on high resolution glass rod lenses. In addition, objectives with a new 4K UHD lens-system have been developed. All 4K UHD optimized endoscopes and objectives are labeled with 4K-logo.

The HD | 4K UHD cameras have a lower sensitivity due to smaller pixel size and therefore require a high-energetic cold light source with daylight quality (color temperature: min. 6.000 K). We recommend our cold light source SKILLLIGHT Xenon 300 or our new developed LED light sources SKILL-LIGHT 1800 LED / 3000 LED.



Ratio 16:9 to 4:3 format

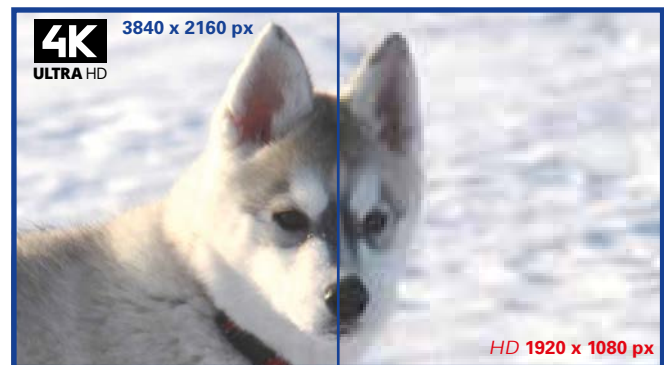

Ratio 4K

HD Resolution

Explanation 4K UHD 3-Shaft Endoscopes

- High-quality, multi-coated (anti-reflective) optical system
- Outstanding optical transmission
- Highly refractive glass for optimum color rendering even under high magnification
- Exceptionally precise centering of optical and mechanical components for a brilliant, high-contrast image even around the edges
- Sealing of the optical system without using adhesive or elastomers but through laser welding and a special soldering process
- Triple-tube design for high bending resistance with many endoscopes
- Nitrogen-filled optical system to avoid interior fogging

Endoscope



134° C
18 min AUTOCLAVE
273° F

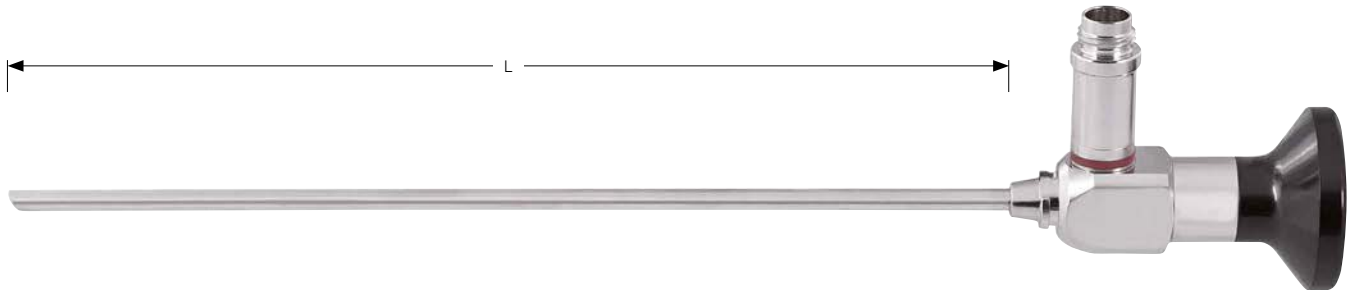

| Length | Ø | 0° | | | | 30° | | | | 45° | | | | 70° | | | |
|----------|--------|-------------------|---|------------------|---|--------------------|---|--|--|--------------------|--|--|--|--------------------|--|------------------|---|
| | | [Diagram: 0° tip] | | | | [Diagram: 30° tip] | | | | [Diagram: 45° tip] | | | | [Diagram: 70° tip] | | | |
| 110,0 mm | 2,7 mm | CH-100-00 | ■ | CH-100-30 | ■ | | | | | | | | | | | CH-100-70 | ■ |
| 140,0 mm | 2,7 mm | CH-101-00 | ■ | CH-101-30 | ■ | | | | | | | | | | | | |
| 175,0 mm | 2,7 mm | CH-102-00 | ■ | CH-102-30 | ■ | | | | | | | | | | | CH-102-70 | ■ |
| 187,5 mm | 2,7 mm | CH-103-00 | ■ | CH-103-30 | ■ | | | | | | | | | | | CH-103-70 | ■ |
| 175,0 mm | 4,0 mm | CH-104-00 | ■ | CH-104-30 | ■ | CH-104-45 | ■ | | | | | | | | | CH-104-70 | ■ |

3-Shaft Endoscope

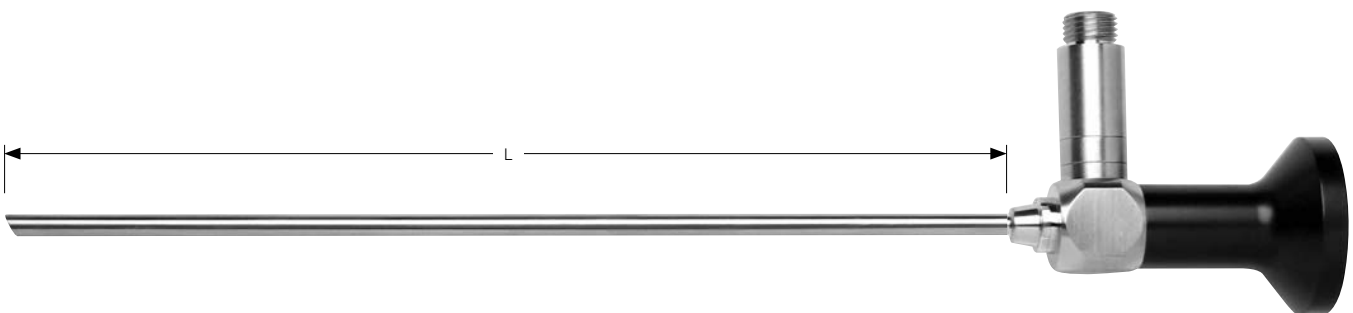

| Length | Ø | 0° | | | | 30° | | | | 45° | | | | 70° | | | |
|----------|--------|----------------------|--|----------------------|--|----------------------|--|----------------------|--|--------------------|--|--|--|--------------------|--|--|--|
| | | [Diagram: 0° tip] | | | | [Diagram: 30° tip] | | | | [Diagram: 45° tip] | | | | [Diagram: 70° tip] | | | |
| 175,0 mm | 4,0 mm | CH-104-00 UHD | | CH-104-30 UHD | | CH-104-45 UHD | | CH-104-70 UHD | | | | | | | | | |

Otoscopes



134° C
18 min AUTOCLAVE
273° F

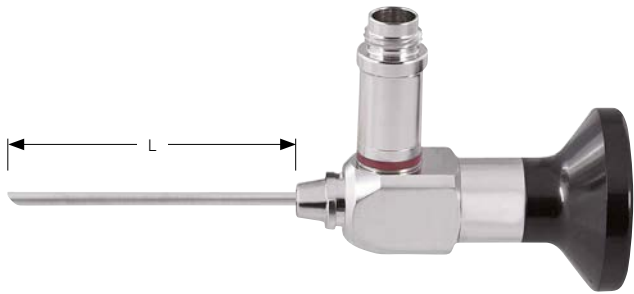

0°

30°

Length

Ø

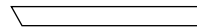
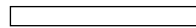

| | | | | | |
|---------|--------|------------------|--------------------------------------|------------------|------------------------------------|
| 50,0 mm | 2,7 mm | CH-105-00 | ■ | CH-105-30 | ■ |
| 50,0 mm | 4,0 mm | CH-106-00 | ■ | CH-106-30 | ■ |

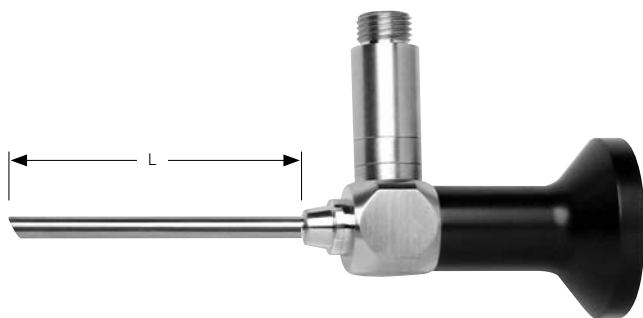

0°

30°

Length

Ø

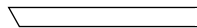
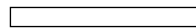

| | | | | | |
|---------|--------|----------------------|--|----------------------|--|
| 50,0 mm | 4,0 mm | CH-106-00 UHD | | CH-106-30 UHD | |
|---------|--------|----------------------|--|----------------------|--|

Laryngoscopes



134° C
18 min AUTOCLAVE
273° F

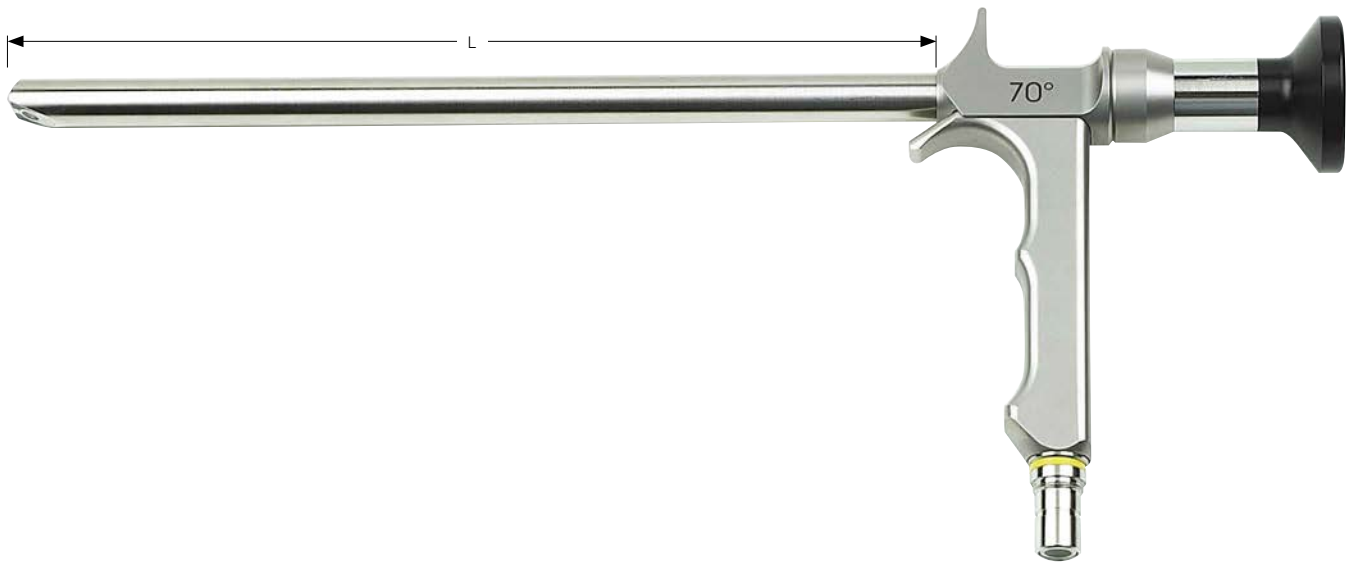

| Length | Ø | 70° | 90° |
|----------|---------|--|--|
| 190,0 mm | 10,0 mm | CH-108-70 ■ | CH-108-90 ■ |





Bronchoscopes



134° C
18 min AUTOCLAVE
273° F



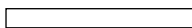



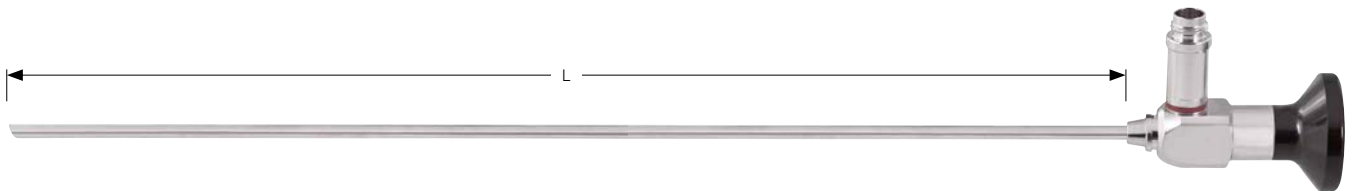

0°

| Length | Ø | | |
|----------|--------|---|--|
| 303,0 mm | 2,9 mm |  | CH-123-00  |
| 540,0 mm | 5,5 mm | | CH-126-00  |



0°

30°

| Length | Ø |  |  |
|----------|--------|--|--|
| 360,0 mm | 2,9 mm | CH-133-00  | CH-133-30  |
| 410,0 mm | 4,0 mm | | CH-134-30  |
| 489,0 mm | 5,5 mm | CH-136-00  | CH-136-30  |

Flexible Naso-Pharyngo-/Laryngoscopes



Accessoires:
- Leakage tester
- ETO-Cap

CH-149-00 Ø 2,2 mm

One hand control, 2-side angulation, length of angulated tip 20 mm

| Length | Fibre bundle | Angulation up down | Direction of view | Field of view | Depth of field |
|--------|--------------|----------------------|-------------------|---------------|----------------|
| 300 mm | 6.500 Pixel | 160° 160° | 0° | 88° | 3 - 50 mm |

CH-150-00 Ø 2,8 mm

One hand control, 2-side angulation, length of angulated tip 20 mm

| Length | Fibre bundle | Angulation up down | Direction of view | Field of view | Depth of field |
|--------|--------------|----------------------|-------------------|---------------|----------------|
| 300 mm | 16.000 Pixel | 160° 160° | 0° | 85° | 1 - 50 mm |

CH-152-00 Ø 3,2 mm

One hand control, 2-side angulation, length of angulated tip 20 mm

| Length | Fibre bundle | Angulation up down | Direction of view | Field of view | Depth of field |
|--------|--------------|----------------------|-------------------|---------------|----------------|
| 300 mm | 16.000 Pixel | 160° 160° | 0° | 85° | 1 - 50 mm |

CH-154-00 Ø 3,4 mm

One hand control, 2-side angulation, length of angulated tip 25 mm

| Length | Fibre bundle | Angulation up down | Direction of view | Field of view | Depth of field |
|--------|--------------|----------------------|-------------------|---------------|----------------|
| 300 mm | 16.000 Pixel | 160° 160° | 0° | 85° | 1 - 50 mm |

Flexible Naso-Pharyngo-/Laryngo Ibrescopes with Instrument Channel



Accessoires:
- Leakage tester
- ETO-Cap

CH-156-00 Ø 3,8 mm

One hand control, 2-side angulation, length of angulated tip 20 mm, **instrument channel Ø 1.4 mm**

| Length | Fibre bundle | Angulation up down | Direction of view | Field of view | Depth of field |
|--------|--------------|----------------------|-------------------|---------------|----------------|
| 300 mm | 14.000 Pixel | 160° 160° | 0° | 85° | 3 - 50 mm |



Scope Containers, Endoscopy Baskets



Endoscopy basket with silicone holders for endoscopes



2 Endoscopes

| Dimensions | Dimensions | Dimensions |
|------------------|------------------|------------------|
| 290 x 80 x 55 | 460 x 80 x 55 | 670 x 80 x 55 |
| CH-525-29 | CH-525-46 | CH-525-67 |
| CH-525-30 | CH-526-46 | |

Endoscopy basket with silicone holders for a variable no. of endoscopes



| Dimensions | Dimensions | Dimensions | Dimensions |
|------------------|------------------|------------------|------------------|
| 290 x 160 x 52 | 310 x 150 x 77 | 460 x 160 x 52 | 460 x 225 x 52 |
| CH-527-29 | CH-527-31 | CH-527-33 | CH-528-46 |

Sterilization basket for a variable no. of endoscopes / URS with adjustable holding device

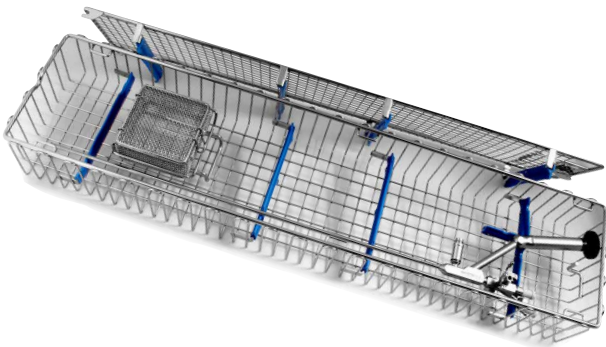

| Dimensions | Dimensions |
|------------------|------------------|
| 580 x 160 x 52 | 640 x 150 x 77 |
| CH-528-58 | CH-528-64 |

Alu scope container, without filters, only for transport and storage, with endoscope holding devices



| Dimensions | Dimensions | Dimensions |
|-------------------|---------------------|------------------|
| 254 x 61,5 x 49,5 | 454 x 72 x 62,5 | 454 x 72 x 62,5 |
| CH-520-05 | CH-55-520-06 | CH-520-07 |
| for endoscope | Ø 2,7 / 4,0 mm | Ø 4,0 / 5,0 mm |
| | | Ø 10,0 mm |

! All dimensions in millimetres (mm)

Steribox® for Endoscope



Sterilising box made of heavy stable plastic with PTFE filter. Autoclavable up to 134° C. Proofed for plasma (STERRAD®) and gas sterilisation.

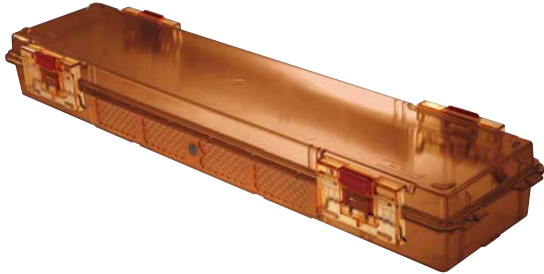

XL

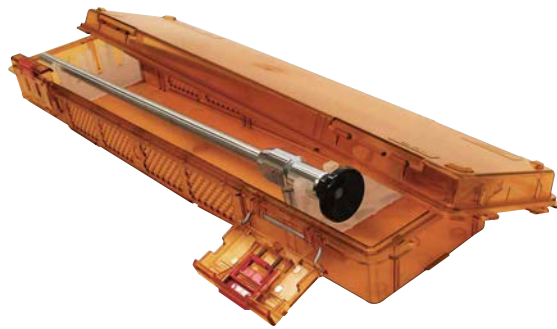

| | Dimensions | Dimensions |
|------------------|------------------|------------------|
| Plastic colour | 497 x 122 x 65 | 497 x 122 x 65 |
| CH-900-04 | CH-900-04 | CH-900-14 |
| | Yearly filter | Permanent filter |

! Steribox without endoscope holding devices

! All dimensions in millimetres (mm)

CH-905-01

Endoscope holding device, 3 x 15 mm / 3 x 2 mm, Unit 2 pcs.

CH-905-02

Endoscope holding device, 3 x 15 mm / 3 x 10 mm, Unit 2 pcs.

PTFE Filter sets



| Size | Yearly filter | Permanent filter |
|------|------------------|------------------|
| XL | CH-901-03 | CH-901-13 |

Indicator label



| Size | Item number |
|-----------|------------------|
| SHIMILIXL | CH-909-02 |



Order quantity: 1000 Indicator labels packed in box

Plastic seal



| Size | Item number |
|-----------|------------------|
| SHIMILIXL | CH-909-01 |



Order quantity: 1000 Plastic seals packed in box

Miscellaneous Accessories



Handle for Endoscopes

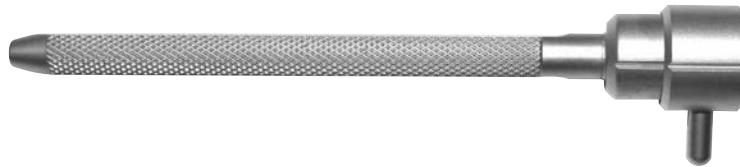

for Endoscope

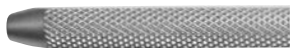

| Version | Ø 2,7 mm | Ø 4,0 mm |
|---------|------------------|------------------|
| Round | CH-950-27 | CH-950-40 |
| Flat | CH-952-27 | CH-952-40 |



CH-990-00

Protection tube for Endoscopes up to Ø 5.0 mm and WL 188 mm

134° C
18 min AUTOCLAVE
273° F



CH-990-02

Protection tube for Endoscopes up to Ø 5.0 mm and WL 302 mm



Miscellaneous Accessories



KARL STORZ
OLYMPUS

CH-995-00

Spare adapter for Endoscopes



RICHARD WOLF

CH-995-02

Spare adapter for Endoscopes



CH-990-90

Polish for Endoscopes



Order quantity: 10 pieces



Order quantity: 10 pieces



CH-995-10

Protection cap for light entry of Endoscopes



CH-990-00

Spare sealing cap

ULTRA-STOP Antifog solution

CH-930-01

30 ml, sterile, in pierce bottle

CH-930-02

25 ml, non sterile, in pipette bottle

CH-930-03

15 ml, non sterile, in spray bottle

1 CCD HD Camera

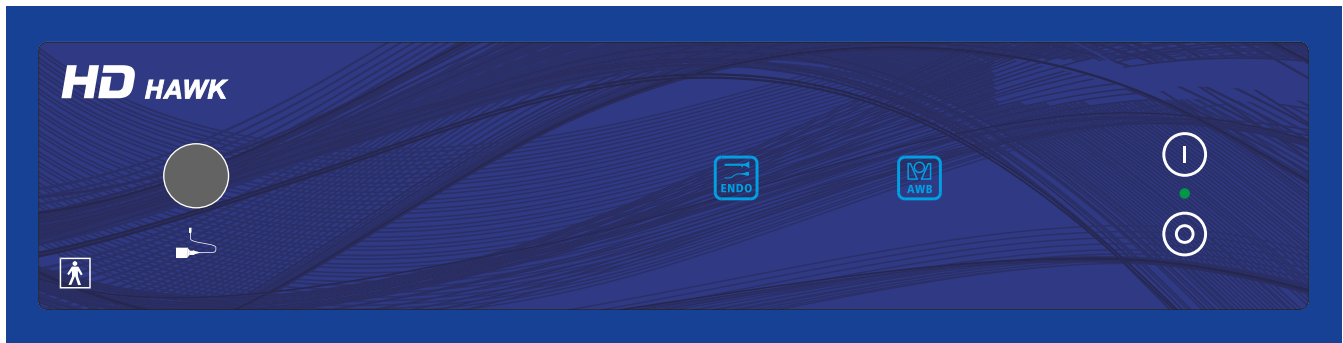

AMNOCAM HAWK | HD

CH-047-00 HD 1 CCD, 1/3"



Camera head with remote control (3 buttons) and cable

CH-047-10 HD

without objective

- 2.5 digital zoom
- Advanced image processor
- Accurate colour rendition
- Ergonomic waterproof camera head with remote function
- Six surgery presets for most common surgeries
- Keyboard input facility
- FREEZE-function for freeze of actual image on the monitor
- Anti-Moiré and Gain function (4 levels)
- Compatible to LED light source
- Fixed shutter mode for stroboscopy
- Foot switch connectivity (optional)
- Automatic White Balance

Technical Data:

| | |
|------------------------|--|
| Image-sensor: | 1/3" High sensitive CCD |
| Resolution: | Full HD 1080p / 1080i / 720p Thru DVI |
| Video output: | DVI-D, RGB 2 x Y/C (S-Video), 2 x Composite |
| Peripheral output: | 2 |
| Power supply: | 115 - 230 V / 50-60 Hz |
| Power consumption: | 25 VA max. |
| Dimensions unit: | 300 x 74 x 360 mm (WxHxD) |
| Weight unit: | approx. 4.5 kg |
| Weight camera head: | approx. 80 g |
| Safety class: | BF |
| Device classification: | I (acc. to MDD 93/42/EEC) |
| Applied standard: | IEC 60601-1 |

Included in delivery:

- Control unit
- Camera head with 3 m cable
- Mains cable
- Instruction manual
- BNC cable
- DVI cable

Portable 1 MOS HD Camera



AMNOCAM PORTABLE | HD

CH-015-00 HD 1 MOS, 1/3"

without objective

- Outstanding price-benefit ratio
- Full HD resolution
- High sensitivity requires less light from illumination
- Advanced image processing for better image quality
- Digital filters for use with fibre flexible scope
- Glass top on controller for easy cleaning
- Metal camera head housing for high durability
- Silicon cable for extra flexibility and sterilization stability

Camera head and cable

CH-015-10 HD

Technical Data:

| | |
|------------------------|-----------------------------------|
| Video system: | Progressive scan with 50 or 60 Hz |
| Image-sensor: | 1/3" MOS |
| Pixels: | FULL HD 1920 x 1080 pixels |
| Horizontal resolution: | > 900 TV-Lines |
| Aspect ratio: | 16:9 |
| Sensitivity: | < 3.0 lux (1/1.4) |
| Video output: | 2 x DVI-D |
| Other connection: | 1 x USB |
| Power supply: | 100-240 V (95 VA) |
| Dimensions unit: | 145 x 32 x 145 mm (WxHxD) |
| Dimensions head: | Ø 37 mm x 68 mm |
| Weight unit: | approx. 0.5 kg |
| Weight camera head: | approx. 90 g |
| Protection class: | I (acc. to IEC 60601-1-2) |
| Safety class: | BF |
| IP code: | IP20 |
| Standard: | IEC 60601-1-2 / IEC 60601-1-1 |
| Device classification: | I (acc. to MDD 93/42/EEC) |

Included in delivery:

- Control unit
- Camera head with 2.95 m cable
- Mains cable
- DVI-D cable
- Instruction manual

Objectives for Cameras, Soakable



SD

| | |
|------------------|-----------|
| CH-080-15 | f = 15 mm |
| CH-080-18 | f = 18 mm |
| CH-080-21 | f = 21 mm |
| CH-080-25 | f = 25 mm |
| CH-080-28 | f = 28 mm |
| CH-080-35 | f = 35 mm |

Standard objective, C-Mount



HD

| | |
|---------------------|-----------|
| CH-082-14 HD | f = 14 mm |
| CH-082-21 HD | f = 21 mm |
| CH-082-25 HD | f = 25 mm |
| CH-082-28 HD | f = 28 mm |

HD Objective, C-Mount



SD

| | |
|------------------|----------------|
| CH-083-01 | f = 15 - 25 mm |
| CH-083-02 | f = 25 - 40 mm |

ZOOM Objective, C-Mount



HD

| | |
|------------------|-----------|
| CH-085-18 | f = 18 mm |
| CH-085-25 | f = 25 mm |
| CH-085-30 | f = 30 mm |

Angled objective 90°, blind, C-Mount



HD

| | |
|------------------|-----------|
| CH-086-18 | f = 18 mm |
| CH-086-25 | f = 25 mm |
| CH-086-30 | f = 30 mm |
| CH-086-35 | f = 35 mm |

Beamsplitter, split 90/10, C-Mount



HD

PARFOCAL

| | |
|------------------|----------------|
| CH-084-02 | f = 15 - 35 mm |
|------------------|----------------|

PARFOCAL ZOOM Objective, C-Mount

The PARFOCAL ZOOM remains focused while changing the zoom factor

LED Cold Light Source



SKILL LIGHT MITHRAS | LED

CH-119-30

- Low noise cooling system
- More light with lower energy consumption
- Colour temperature of approx. 6.000 K equals the sunlight and guarantees an excellent aperture illumination as well as colour reproduction, especially in combination with our SKILL CAM endoscopy cameras
- Stepless controlled light intensity, which guarantees a constant high light quality
- No blackout times and costly lamp exchanges
- Automatic light intensity control via the output signal of a connected SKILL CAM endoscopy camera
- Exchangeable light guide adapter. Standard: SKILL / STORZ
- Ideal for all endoscopic interventions and diagnostic procedures

Technical Data:

| | |
|------------------------|------------------------------------|
| Colour temperature: | 6,000° K |
| LED Lifetime: | > 50,000 hrs. |
| Power supply: | 100 - 240 V AC / 50/60 Hz |
| Power consumption: | max. 100 VA |
| Brightness control: | 0-100% stepless adjustable |
| Light exit: | SKILL / STORZ |
| Video input: | 1 x BNC (Video) |
| Dimensions: | 325 x 74 x 365 mm (WxHxD) |
| Weight: | approx. 6.5 kg |
| Protection class: | IP x 1 |
| Safety class: | BF |
| Standard: | IEC 606011, IEC 60601-1 |
| Device classification: | Class I, acc. to MDD 93 / 42 / EEC |

Included in delivery:

- LED Light source
- Mains cable
- BNC cable
- Instruction manual

Cold Light Cables



In our special cold light cables for Xenon and LED light sources, the glass fibres on the light entry are not any more clued but fused and pressed by means of a special and patented production procedure. Thereby the fibres are hexagonally deformed which allows an accurately fitting in the fibre bundle. The spaces in between disappear and the glass share adds up to 100%. The transmission increases proportionally by approx. 20% compared to standard cold light cables. In combination with the special convex lenses in our Xenon and LED cold light sources, a 50% higher light transmission can be achieved.

Since there are no organic adhesives anymore, these new fibre optic cables no longer burn at the light entry, which used to be a typical cause of failure with conventional cold light cables. The high-performance fibre optic cables are extremely temperature resistant at the point of light entry.

Different packing density of fused and clued cold light cables.

Halogen

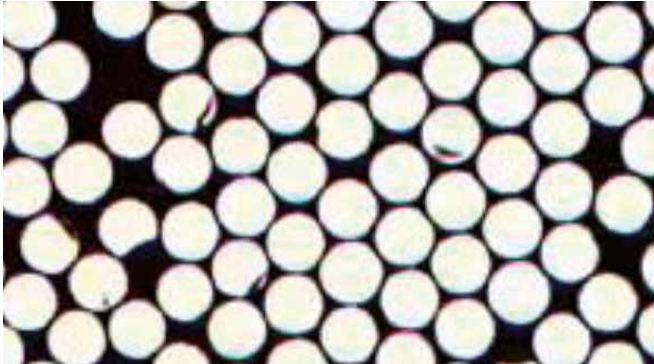

Clued fibres (round)

XENON / LED

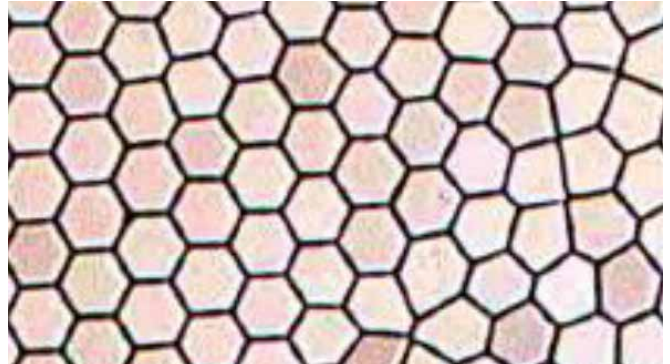

Fused fibres (hexagonal)

LED

Our new LED cold light cables with specially developed glass fibres have been designed and are fabricated for the use with state-of-the-art LED light sources. By enhancing the transmission effectiveness of an already well-established and first-choice fibre optic light cable, the light output and illumination - when operated with a LED light source together with a modern **HD | 4K** UHD endoscope - can be visibly and measurably increased.



LED Cold Light Cables and Adapters



Cold light cables for LED cold light sources



Ø 2,5 mm for Endoscopes Ø 1.7 - 2.0 mm

Ø 3,5 mm for Endoscopes Ø 2.7 - 4.0 mm

LED

| Length | Cable, only | Cable with 2 adapters | Cable, only | Cable with 2 adapters |
|----------|------------------|-----------------------|------------------|-----------------------|
| | Ø 2,5 mm | Ø 2,5 mm | Ø 3,5 mm | Ø 3,5 mm |
| 180,0 cm | CH-133-18 | CH-133-18 C | CH-134-18 | CH-134-18 C |
| 230,0 cm | CH-133-23 | CH-133-23 C | CH-134-23 | CH-134-23 C |
| 250,0 cm | CH-133-25 | CH-133-25 C | CH-134-25 | CH-134-25 C |
| 300,0 cm | CH-133-30 | CH-133-30 C | CH-134-30 | CH-134-30 C |
| 350,0 cm | | | CH-134-35 | CH-134-35 C |
| 400,0 cm | CH-133-40 | CH-133-40 C | CH-134-40 | CH-134-40 C |
| 500,0 cm | CH-133-50 | CH-133-50 C | CH-134-50 | CH-134-50 C |

Adapter unit side



CH-128-00

CH-128-01

CH-128-03

CH-128-04

SKILL
STORZ
AESCULAP
LINVATEC
WISAP

WOLF
HSW
DYONICS
MEDICON
COMEG

OLYMPUS
NEW (switch)

ACMI
BRITISH
CODMAN
STRYKER
WELCH ALLYN

Adapter endoscope side



CH-129-00

CH-129-01

CH-129-04

SKILL
STORZ
AESCULAP
WINTER & IBE
WISAP

WOLF Snap
HSW
DYONICS
MEDICON

OLYMPUS
NEW

Further adapters for all current Endoscopes and light sources available on request

LED Cold Light Source



| | |
|------------------------|------------------------------------|
| Technical Data: | 10 VA |
| Power consumption: | max. 1,000 lumens |
| Brightness: | Turbo High Medium Low Moon |
| Brightness level: | Wolf |
| Light exit: | 63 x 21 mm |
| Dimensions: | 51 g incl. battery |
| Weight: | Turbo 37 min. |
| Battery life: | High 45 min. |
| | Medium 3 hrs. 40 min. |
| | Low 20 hrs. |
| | Moon 8 days |

LIGHT MINI | LED

CH-102-10

- Intensive Lightning
- 5 adjustable brightness levels
- Water resistant
- Incl. USB-Magnetic chip
- Ergonomic design
- Long life time battery

Included in delivery:

- Light source
- Battery
- USB-Magnetic chip



CH-102-90

CH-102-10 Cleaning adapter for SKILL LIGHT MINI CH-102-10





Otology



Table of Content | Chapter

















| Product group | Page |
|---|-----------|
|  Tuning Forks, Noise Drum | 30 |
| <hr style="border-top: 1px dotted black;"/> | |
|  Nystagmus Spectacles, Head Lights | 33 |
| <hr style="border-top: 1px dotted black;"/> | |
|  Ear Syringes, Powder Blower | 38 |
| <hr style="border-top: 1px dotted black;"/> | |
|  Air Bags, Ear Catheters | 40 |
| <hr style="border-top: 1px dotted black;"/> | |
|  Ear Speculas, Aural Magnifier, Diagnostic Sets | 42 |
| <hr style="border-top: 1px dotted black;"/> | |
|  Ear Curettes, Ear Hooks, Ear Looks, Foreign Body Instruments | 54 |
| <hr style="border-top: 1px dotted black;"/> | |
|  Ear Polypus Forceps, Ear Dressing Forceps, Ear Forceps, Ear Polypus Snares | 58 |
| <hr style="border-top: 1px dotted black;"/> | |
|  Periosteal Knives, Myringotome, Tympanum Perforators | 62 |
| <hr style="border-top: 1px dotted black;"/> | |

Table of Content | Chapter



| Product group | Page |
|---|--|
|  | <p>Suction Tubes, Suction and Irrigation Instruments 65</p> <hr style="border-top: 1px dotted black;"/> |
|  | <p>Elevators, Raspatories 68</p> <hr style="border-top: 1px dotted black;"/> |
|  | <p>Chisels, Gouges, Mallets 72</p> <hr style="border-top: 1px dotted black;"/> |
|  | <p>Bone Curettes, Rongeurs 75</p> <hr style="border-top: 1px dotted black;"/> |
|  | <p>Micro Ear Knives, Micro Instruments 78</p> <hr style="border-top: 1px dotted black;"/> |
|  | <p>Micro Ear Forceps, Scissors, Micro Cup-shaped Forceps, Wire Bending Forceps 88</p> <hr style="border-top: 1px dotted black;"/> |
|  | <p>Ear Forceps 94</p> <hr style="border-top: 1px dotted black;"/> |

Turning Forks Diapason



With clamp



With foot

HARTMANN (FRENCH)

| | | |
|------------------|----------------|--------|
| CH-000-01 | C ₂ | 16 Hz |
| CH-000-02 | C ₁ | 32 Hz |
| CH-000-03 | C | 64 Hz |
| CH-000-04 | c | 128 Hz |
| CH-000-05 | c ¹ | 256 Hz |

HARTMANN

| | | |
|------------------|----------------|---------|
| CH-001-01 | c | 128 Hz |
| CH-001-02 | c ¹ | 256 Hz |
| CH-001-03 | c ² | 512 Hz |
| CH-001-04 | c ³ | 1024 Hz |
| CH-001-05 | c ⁴ | 2048 Hz |
| CH-001-06 | c ⁵ | 4096 Hz |

LUCAE

| | | |
|------------------|----------------|---------|
| CH-004-01 | c | 128 Hz |
| CH-004-02 | c ¹ | 256 Hz |
| CH-004-03 | c ² | 512 Hz |
| CH-004-04 | c ³ | 1024 Hz |
| CH-004-05 | c ⁴ | 2048 Hz |
| CH-004-06 | c ⁵ | 4096 Hz |



With clamp

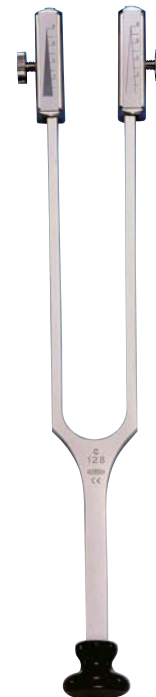

With clamp C 64 Hz
Without clamp c 128 Hz

| | | |
|------------------|----------------|--------|
| CH-005-01 | c | 64 Hz |
| CH-005-02 | c | 128 Hz |
| CH-005-03 | c ¹ | 256 Hz |

| | | |
|------------------|----------------|---------|
| CH-005-04 | c ² | 512 Hz |
| CH-005-05 | c ³ | 1024 Hz |
| CH-005-06 | c ⁴ | 2048 Hz |
| CH-005-07 | c ⁵ | 4096 Hz |

RYDEL-SEIFFER

CH-008-01

Turning Forks D



Adjustable up to **h 240 Hz**

Adjustable up to **h 240 Hz**



With foot

CH-010-01 a¹ 440 Hz

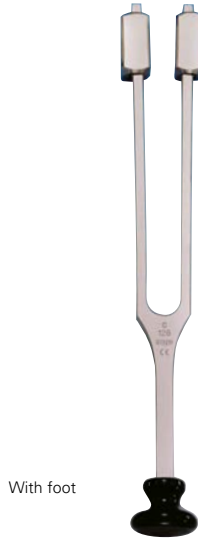

With foot

LUCAE
CH-012-01 c 128 Hz

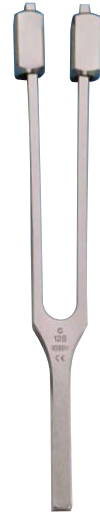

HARTMANN
CH-013-01 c 128 Hz

Adjustable up to **g 194 Hz**

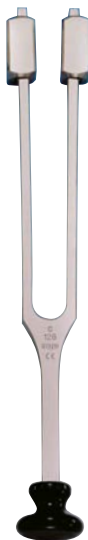

With foot

KOENIG
CH-015-01 A 109 Hz



CH-018-00 C 275 Hz

Tuning fork for neurological examinations, with percussion hammer, pin wheel, brush and needle.

Turning Forks, Noise Drum



CH-005-00 SET

Complete, consisting of: CH-005-02, -03, -04, -05, -06



HARTMANN

CH-007-00 SET

Complete, consisting of: CH-001-03, CH-001-04, CH-001-05, CH-000-04, CH-000-05



HARTMANN

CH-007-01 SET

Complete, consisting of: CH-001-03, CH-001-04, CH-001-05, CH-001-06, CH-000-04, CH-000-05

HARTMANN

CH-008-00 SET

Complete, consisting of: CH-001-03, CH-001-04, CH-001-05, CH-001-06, CH-000-02, CH-000-03, CH-000-04, CH-000-05

BARANY

CH-020-00

Noise drum with ear olive



Nystagmus Spectacles



FRENZEL

CH-090-00

Nystagmus spectacles, 1.5 m cord and clip headband



CH-090-90

Transformer 4 V, for Frenzel spectacles CH-090-00

CH-090-99

Spare Bulb , 4 V, for Frenzel spectacles CH-090-00



FRENZEL

CH-090-04

Nystagmus spectacles with transverse battery handle



FRENZEL **LED**

CH-090-10

LED Nystagmus spectacles with transverse battery



BLESSING **LED**

CH-090-16

LED Nystagmus spectacles with rechargeable battery box and charger

Re Lex Head Mirror, Headlights



ZIEGLER

CH-049-00

Reflex head mirror, Ø 90 mm, narrow head band



CLAR

CH-042-02

Concave mirror Ø 55 mm, adjustable ergonomic head band, 2 m cord with banana plugs



CLAR F

CH-042-03

Foam bolstered ergonomic headband, light beam focusable by control knob, easily replaceable mirror, 2 m divisible cord with banana plugs, Mirror Ø 55 mm



CLAR F LED

CH-042-04

LED-Headlight, Ø 55 mm wireless, with battery box (3x type AA) at the headband



CH-042-09

Wall plug transformer for headlights, 6 V, max. 1.5 A, 2x banana plug

Headlights, Fibre Optic



CH-042-50

Headlight with stepless variable micro focus for intensive depth illumination



CH-042-52

Fibre Optic miniature Headlight for operation theatre, with cross band



CH-042-60

Modern focusable Fibre Optic Headlight with high performance optical system, headband with top, black



Headlights



CH-042-00

High performance, focusable headlight



CH-044-30

High performance, focusable headlight, with warm light



CH-044-35

High performance, focusable headlight, with rechargeable LiPo battery and charger



CH-044-36

Spare battery LiPo, for LED headlight CH-044-35



Headlights



CH-044-40

Wireless, modern, focusable LED headlight with powerful optical system



CH-044-50 SET

Wireless High Power Head light, focusable, incl. 2 rechargeable batteries, charger, wall plug power supply for charger, case



CH-044-60

Black auto switch headlight, incl. charger and desktop charging stand



Ear Syringes



- CH-044-05** 50 ml
- CH-044-07** 75 ml
- CH-044-10** 100 ml
- CH-044-15** 150 ml



CH-041-11



CH-041-12

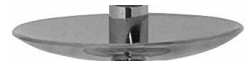

CH-041-13



CH-042-00 10 ml



CH-042-01



CH-042-05



CH-042-04



CH-042-03



CH-042-02



CH-042-09



CH-042-08



CH-042-07



CH-042-06

Powder Blowers



CH-036-13 130 mm



CH-036-11 110 mm

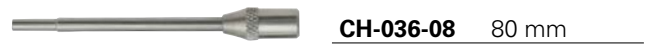

CH-036-08 80 mm

KABIERSKE

CH-036-00 SET

Complete, consisting of:

| | |
|-----------------------|------------------|
| 1 Valve rubber Bulb | CH-036-50 |
| 1 Bottle | CH-036-01 |
| 1 Ear cannula, 80 mm | CH-036-08 |
| 1 Ear cannula, 110 mm | CH-036-11 |
| 1 Ear cannula, 130 mm | CH-036-13 |
| 1 Atomizer | CH-036-40 |

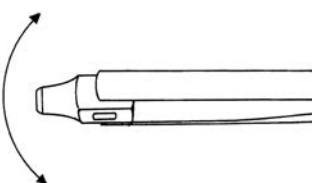

UNIVERSAL
CH-039-00

for Rhinology

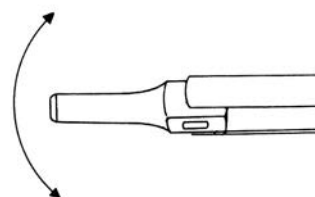

UNIVERSAL
CH-040-00

for Otology

Air Bags



POLITZER

CH-034-00 SET

Complete, consisting of:

| | |
|-------------------------|------------------|
| 1 Rubber Bulb | CH-034-50 |
| 1 Connecting nozzle | CH-034-03 |
| 1 Nose olive, Ø 15,0 mm | CH-034-15 |
| 1 Nose olive, Ø 17,0 mm | CH-034-17 |
| 1 Nose olive, Ø 12,0 mm | CH-034-22 |



POLITZER

CH-034-01 SET

Complete, consisting of:

| | |
|-------------------------|------------------|
| 1 Rubber Bulb | CH-034-50 |
| 1 Connecting nozzle | CH-034-03 |
| 1 Ear olive, Ø 4,0 mm | CH-034-04 |
| 1 Nose olive, Ø 15,0 mm | CH-034-15 |
| 1 Nose olive, Ø 17,0 mm | CH-034-17 |
| 1 Nose olive, Ø 12,0 mm | CH-034-22 |



POLITZER-ASEPTIC

CH-034-02 SET

Complete, consisting of:

| | |
|-------------------------|------------------|
| 1 Rubber Bulb | CH-034-50 |
| 1 Connecting nozzle | CH-034-03 |
| 1 Ear olive, Ø 4,0 mm | CH-034-04 |
| 1 Nose olive, Ø 15,0 mm | CH-034-15 |
| 1 Nose olive, Ø 17,0 mm | CH-034-17 |
| 1 Nose olive, Ø 12,0 mm | CH-034-22 |

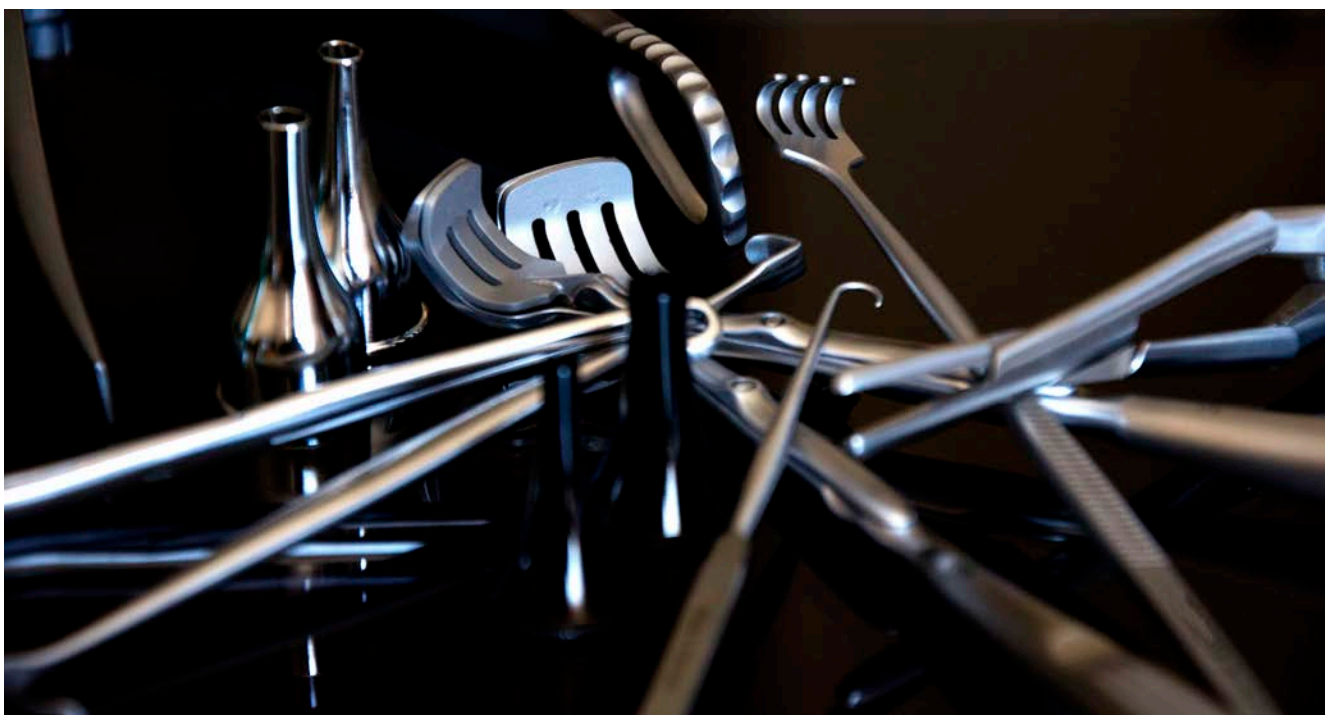

Air Bags, Ear Catheters



POLITZER
CH-034-50



POLITZER
CH-034-04 Ø 4,0 mm



POLITZER
CH-034-15 Ø 15,0 mm



POLITZER
CH-034-03



POLITZER
CH-034-17 Ø 17,0 mm



PO
CH-034-22 Ø 22,0 mm



HARTMANN
CH-031-05 15,0 cm, 6"



Fig. 0

CH-031-00



Fig. 1

CH-031-01



Fig. 2

CH-031-02



Fig. 3

CH-031-03



Fig. 4

CH-031-04



Fig. 5

CH-031-05

Ear Speculas



Fig. 1



4,5 x 5,5 mm

CH-101-01

Fig. 2



5,5 x 6,5 mm

CH-101-02

Fig. 3



6,5 x 7,5 mm

CH-101-03

Fig. 4



7,5 x 8,5 mm

CH-101-04

Fig. 5



8,5 x 9,5 mm

CH-101-05

Fig. 6



9,5 x 10,5 mm

CH-101-06

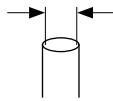

Inside Diameter

ZOELLNER

- CH-101-01** Fig. 1 | 38 mm
- CH-101-02** Fig. 2 | 38 mm
- CH-101-03** Fig. 3 | 38 mm
- CH-101-04** Fig. 4 | 38 mm
- CH-101-05** Fig. 5 | 38 mm
- CH-101-06** Fig. 6 | 38 mm

ZOELLNER

- CH-101-00** Set
- consisting of: Fig. 1 - Fig. 6 | (6 pieces)

ZOELLNER

- CH-101-50** Set
- consisting of: Fig. 1 - Fig. 3 | (3 pieces)

ZOELLNER

- CH-101-60** Set
- consisting of: Fig. 4 - Fig. 6 | (3 pieces)

Fig. 1



3,3 mm

CH-102-01

Fig. 2



4,3 mm

CH-102-02

Fig. 3



4,8 mm

CH-102-03

Fig. 4



5,3 mm

CH-102-04

Fig. 5



5,8 mm

CH-102-05

Fig. 6



6,3 mm

CH-102-06

Fig. 7



6,7 mm

CH-102-07

Fig. 8



7,2 mm

CH-102-08

Fig. 9



7,7 mm

CH-102-09

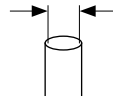

Inside Diameter

FARRIOR

- CH-102-01** Fig. 1 | 43 mm
- CH-102-02** Fig. 2 | 43 mm
- CH-102-03** Fig. 3 | 43 mm
- CH-102-04** Fig. 4 | 43 mm
- CH-102-05** Fig. 5 | 43 mm
- CH-102-06** Fig. 6 | 43 mm
- CH-102-07** Fig. 7 | 43 mm
- CH-102-08** Fig. 8 | 43 mm
- CH-102-09** Fig. 9 | 43 mm

FARRIOR

- CH-102-00** Set
- consisting of: Fig. 1 - Fig. 9 | (9 pieces)

Ear Speculas



Fig. 1



2,0 mm

CH-103-02

Fig. 2



3,0 mm

CH-103-03

Fig. 3



4,0 mm

CH-103-04

Fig. 4



5,0 mm

CH-103-05

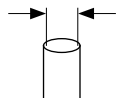

Inside Diameter

POLITZER

CH-103-02 Fig. 1 | 27 mm

CH-103-03 Fig. 2 | 27 mm

CH-103-04 Fig. 3 | 27 mm

CH-103-05 Fig. 4 | 27 mm

POLITZER

CH-103-00 Set

consisting of: Fig. 1 - Fig. 3 | (3 pieces)

POLITZER

CH-103-01 Set

consisting of: Fig. 1 - Fig. 4 | (4 pieces)

Fig. 1



1,7 mm

CH-103-18

Fig. 2



3,2 mm

CH-103-32

Fig. 3



4,7 mm

CH-103-46

Fig. 1



1,7 mm

CH-103-58

Fig. 2



3,2 mm

CH-103-72

Fig. 3



4,7 mm

CH-103-87

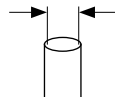

Inside Diameter

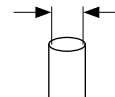

Inside Diameter

HARTMANN

CH-103-18 Fig. 1

CH-103-32 Fig. 2

CH-103-46 Fig. 3

HARTMANN

CH-103-10 Set

consisting of: Fig. 1 - Fig. 3 | (3 pieces)

HARTMANN

CH-103-58 Fig. 1

CH-103-72 Fig. 2

CH-103-87 Fig. 3

HARTMANN

CH-27-103-50 Set

consisting of: Fig. 1 - Fig. 3 | (3 pieces)

Ear Speculas



Fig. 1



2,0 mm

CH-104-25

Fig. 2



3,0 mm

CH-104-03

Fig. 3



4,0 mm

CH-104-04

Fig. 4



5,5 mm

CH-104-05

Fig. 5



6,5 mm

CH-104-06

Fig. 6



8,0 mm

CH-104-08

Fig. 9



9,0 mm

CH-104-09

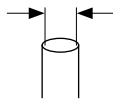

Inside Diameter

HARTMANN

| | |
|------------------|--------|
| CH-104-25 | Fig. 1 |
| CH-104-03 | Fig. 2 |
| CH-104-04 | Fig. 3 |
| CH-104-05 | Fig. 4 |
| CH-104-06 | Fig. 5 |
| CH-104-08 | Fig. 6 |
| CH-104-09 | Fig. 7 |

HARTMANN

| | |
|---|-----|
| CH-104-00 | Set |
| consisting of: Fig. 3 - Fig. 6 (4 pieces) | |

HARTMANN

| | |
|---|-----|
| CH-CH-104-01 | Set |
| consisting of: Fig. 4 - Fig. 6 (3 pieces) | |

HARTMANN

| | |
|---|-----|
| CH-104-02 | Set |
| consisting of: Fig. 2 - Fig. 4 (3 pieces) | |

Fig. 1



3,0 mm

CH-104-30

Fig. 2



3,5 mm

CH-104-35

Fig. 3



4,0 mm

CH-104-40

Fig. 4



4,5 mm

CH-104-45

Fig. 5



5,0 mm

CH-104-50

Fig. 6



5,5 mm

CH-104-55

Fig. 7



6,0 mm

CH-104-60

Fig. 8



6,5 mm

CH-104-65

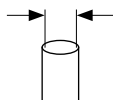

Inside diameter

Fig. 9



7,0 mm

CH-104-70

Fig. 10



7,5 mm

CH-104-75

Fig. 11



8,0 mm

CH-104-80

Fig. 12



9,0 mm

CH-104-90

HARTMANN

| | |
|------------------|---------|
| CH-104-30 | Fig. 1 |
| CH-104-35 | Fig. 2 |
| CH-104-40 | Fig. 3 |
| CH-104-45 | Fig. 4 |
| CH-104-50 | Fig. 5 |
| CH-104-55 | Fig. 6 |
| CH-104-60 | Fig. 7 |
| CH-104-65 | Fig. 8 |
| CH-104-70 | Fig. 9 |
| CH-104-75 | Fig. 10 |
| CH-104-80 | Fig. 11 |
| CH-104-90 | Fig. 12 |

HARTMANN

| | |
|---|-----|
| CH-104-92 | Set |
| consisting of: Fig. 11 - Fig. 12 (2 pieces) | |

HARTMANN

| | |
|--|-----|
| CH-104-93 | Set |
| consisting of: Fig. 1, 3, 6 (3 pieces) | |

HARTMANN

| | |
|---|-----|
| CH-104-94 | Set |
| consisting of: Fig. 1, 3, 6, 9 (3 pieces) | |



Packing unit: 5 pieces

Ear Speculas



Fig. 1



3,0 mm

CH-105-03

Fig. 2



4,0 mm

CH-105-04

Fig. 3



5,0 mm

CH-105-05

Fig. 4



7,0 mm

CH-105-07

Fig. 5



8,0 mm

CH-105-08

Fig. 6



9,0 mm

CH-105-09

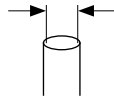

Inside Diameter

HARTMANN

| | |
|------------------|--------|
| CH-105-03 | Fig. 1 |
| CH-105-04 | Fig. 2 |
| CH-105-05 | Fig. 3 |
| CH-105-07 | Fig. 4 |
| CH-105-08 | Fig. 5 |
| CH-105-09 | Fig. 6 |

HARTMANN

| | |
|------------------|---|
| CH-105-00 | Set |
| consisting of: | Fig. 1 - Fig. 4 I (4 pieces) Fig. 1 - Fig. 4 I (4 piezas) Fig. 1 - Fig. 4 I (4 pezzi) |

Fig. 0



3,0 mm

CH-106-02

Fig. 1



3,5 mm

CH-106-03

Fig. 2



4,5 mm

CH-106-04

Fig. 3



5,5 mm

CH-106-05

Fig. 4



6,5 mm

CH-106-06

Fig. 5



7,6 mm

CH-106-07

Fig. 6



9,1 mm

CH-106-09

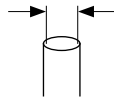

Inside Diameter

BOUCHERON

| | |
|------------------|--------|
| CH-106-02 | Fig. 0 |
| CH-106-03 | Fig. 1 |
| CH-106-04 | Fig. 2 |
| CH-106-05 | Fig. 3 |
| CH-106-06 | Fig. 4 |
| CH-106-07 | Fig. 5 |
| CH-106-09 | Fig. 6 |

BOUCHERON

| | | | |
|-----------------|------------------------------|------------------|------------------------------|
| CH106-00 | Set | CH-106-01 | Set |
| consisting of: | Fig. 1 - Fig. 4 I (4 pieces) | consisting of: | Fig. 2 - Fig. 5 I (4 pieces) |

Ear Speculas



Fig. 1



3,0 x 4,0 mm

CH-107-01

Fig. 2



4,0 x 5,0 mm

CH-107-02

Fig. 3



4,5 x 5,5 mm

CH-107-03

Fig. 4



5,0 x 6,0 mm

CH-107-04

Fig. 5



5,5 x 6,5 mm

CH-107-05

Fig. 6



6,0 x 7,0 mm

CH-107-06

Fig. 7



6,5 x 7,5 mm

CH-107-07

Fig. 8



7,0 x 8,0 mm

CH-107-08

Fig. 9



7,5 x 8,5 mm

CH-107-09

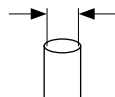

Inside Diameter

FARRIOR

- CH-107-01** Fig. 1 | 43 mm
- CH-107-02** Fig. 2 | 43 mm
- CH-107-03** Fig. 3 | 43 mm
- CH-107-04** Fig. 4 | 43 mm
- CH-107-05** Fig. 5 | 43 mm
- CH-107-06** Fig. 6 | 43 mm
- CH-107-07** Fig. 7 | 43 mm
- CH-107-08** Fig. 8 | 43 mm
- CH-107-09** Fig. 9 | 43 mm

FARRIOR

- CH-107-10** Set
 consisting of: Fig. 1 - Fig. 9 | (9 pieces)

FARRIOR

- CH-107-00** Set
 consisting of: Fig. 1,2,5,7,9 | (5 pieces)

Fig. 1



3,0 x 4,0 mm

CH-107-11

Fig. 2



4,0 x 5,0 mm

CH-107-12

Fig. 3



4,5 x 5,5 mm

CH-107-13

Fig. 4



5,0 x 6,0 mm

CH-107-14

Fig. 5



5,5 x 6,5 mm

CH-107-15

Fig. 6



6,0 x 7,0 mm

CH-107-16

Fig. 7



6,5 x 7,5 mm

CH-107-17

Fig. 8



7,0 x 8,0 mm

CH-107-18

Fig. 9



7,5 x 8,5 mm

CH-107-19

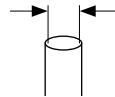
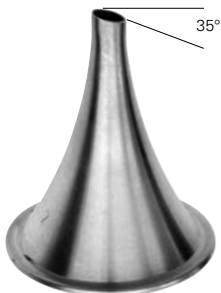

Inside Diameter

FARRIOR

- CH-107-11** Fig. 1 | 43 mm
- CH-107-12** Fig. 2 | 43 mm
- CH-107-13** Fig. 3 | 43 mm
- CH-107-14** Fig. 4 | 43 mm
- CH-107-15** Fig. 5 | 43 mm
- CH-107-16** Fig. 6 | 43 mm
- CH-107-17** Fig. 7 | 43 mm
- CH-107-18** Fig. 8 | 43 mm
- CH-107-19** Fig. 9 | 43 mm

FARRIOR

- CH-107-20** Set
 consisting of: Fig. 1 - Fig. 9 | (9 pieces)

FARRIOR

- CH-107-21** Set
 consisting of: Fig. 1,2,5,7,9 | (5 pieces)

Ear Speculas



Fig. 0



2,0 mm

CH-108-02

Fig. 1



3,0 mm

CH-108-03

Fig. 2



4,0 mm

CH-108-04

Fig. 3



5,0 mm

CH-108-05

Fig. 4



6,0 mm

CH-108-06

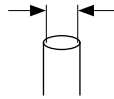

Inside Diameter

TOYNBEE

- CH-108-02** Fig. 0 | 33 mm
- CH-108-03** Fig. 1 | 36 mm
- CH-108-04** Fig. 2 | 36 mm
- CH-108-05** Fig. 3 | 36 mm
- CH-108-06** Fig. 4 | 35 mm

TOYNBEE

- CH-108-10** Set
- consisting of: Fig. 0 - Fig. 4 | (5 pieces)

TOYNBEE

- CH-108-00** Set
- consisting of: Fig. 1 - Fig. 4 | (4 pieces)

TOYNBEE

- CH-27-108-01** Set
- consisting of: Fig. 2 - Fig. 4 | (3 pieces)

Fig. 1



2,8 x 3,8 mm

CH-109-04

Fig. 2



3,8 x 4,8 mm

CH-109-05

Fig. 3



5,0 x 6,2 mm

CH-109-06

Fig. 4



6,0 x 7,2 mm

CH-109-07

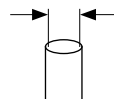

Inside Diameter

GRUBER

- CH-109-04** Fig. 1 | 42 mm
- CH-109-05** Fig. 2 | 42 mm
- CH-109-06** Fig. 3 | 42 mm
- CH-109-07** Fig. 4 | 42 mm

GRUBER

- CH-109-00** Set
- consisting of: Fig. 1 - Fig. 4 | (4 pieces)

GRUBER

- CH-27-109-01** Set
- consisting of: Fig. 2 - Fig. 4 | (3 pieces)

Ear Speculas, Aural Magnifier



CH-110-04



CH-110-05



CH-110-06

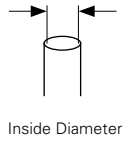

Rack for 12 Ear Speculas

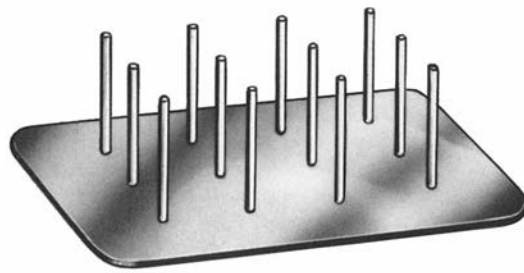

HOLMGREEN

CH-110-04 4 - 12 mm

CH-110-05 5 - 13 mm

CH-110-06 6 - 14 mm

CH-110-99



Fig. 1



CH-118-02



Fig. 2



CH-118-03



Fig. 3



CH-118-04

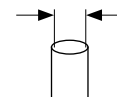

SIEGLE

CH-118-00 SET

Complete, consisting of:

| | |
|-------------------------|------------------|
| 1 Rubber Bulb | CH-118-01 |
| 1 Ear Specula, Ø 5,0 mm | CH-118-02 |
| 1 Ear Specula, Ø 6,0 mm | CH-118-03 |
| 1 Ear Specula, Ø 7,0 mm | CH-118-04 |
| 1 Diagnostic head | CH-118-05 |

Ear Speculas, Aural Magnifier



Fig. 1



2,5 mm

Fig. 2



3,0 mm

Fig. 3



4,0 mm

Fig. 4



5,0 mm

Fig. 5



6,5 mm

Fig. 6



8,5 mm

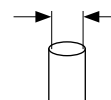

Inside Diameter

BRUENINGS

CH-120-00 SET

Complete in case, consisting of:

- 1 Ear Specula, Ø 3,0 mm
- 1 Ear Specula, Ø 4,0 mm
- 1 Ear Specula, Ø 5,0 mm
- 1 Ear Specula, Ø 6,5 mm
- 1 Rubber Bulb with tube
- 1 Diagnostic head, full lens

BRUENINGS

CH-121-00 SET

Complete in case, consisting of: 1

- Ear Specula, Ø 2,5 mm
- 1 Ear Specula, Ø 3,0 mm
- 1 Ear Specula, Ø 4,0 mm
- 1 Ear Specula, Ø 5,0 mm
- 1 Ear Specula, Ø 6,5 mm
- 1 Ear Specula, Ø 8,5 mm
- 1 Rubber Bulb with tube
- 1 Diagnostic head, full lens
- 1 Diagnostic head, segmented lens

Diagnostic Sets Juego



RI-SCOPE

CH-048-01

2,5 V

Diagnostic Set complete in case, consisting of:

- 1 Battery handle (without batteries)
- 1 Ophthalmoscope with Halogen Bulb , 2,5 V
- 1 Otoscope head with Halogen Bulb , 2,5 V
- 1 Reusable ear Specula, Ø 2,0 | 3,0 | 4,0 | 5,0 mm
- 3 Disposable ear Specula, Ø 2,5 | 4,0 mm
- 1 Magnifying glass for operation, 4 x
- 2 Spare Bulb , Halogen, 2,5 V



Diagnostic Sets Juero



RI-SCOPE

CH-048-02

2,5 V

Universal Diagnostic Set complete in case, consisting of:

- 1 Battery handle (without batteries)
- 1 Ophthalmoscope with Halogen Bulb , 2,5 V
- 1 Otoscope head with Halogen Bulb , 2,5 V
- 1 Nasal Specula with Bulb and magnifyer
- 1 Tongue depressor holder with Bulb
- 1 Lamp holder with Bulb
- 1 Laryngeal mirrors for lamp holder, Ø 20,0 | 22,0 mm
- 1 Reusable ear Specula, Ø 2,0 | 3,0 | 4,0 | 5,0 mm
- 3 Disposable ear Specula, Ø 2,5 | 4,0 mm
- 2 Spare Bulb , Halogen, 2,5 V



Diagnostic Sets Juero



RI-SCOPE

CH-048-05 2,5V

ENT Diagnostic Set complete in case, consisting of:

-
- 1 Battery handle (without batteries)
 - 1 Otoscope head with Halogen Bulb , 2,5 V
 - 1 Nasal Specula with Bulb and magnifyer
 - 1 Tongue depressor holder with Bulb
 - 1 Magnifying glass for operation, 4 x
 - 1 Reusable ear Specula, Ø 2,0 | 3,0 | 4,0 | 5,0 mm
 - 3 Disposable ear Specula, Ø 2,5 | 4,0 mm
 - 1 Spare Bulb , Halogen, 2,5V

RI-SCOPE *LED*

CH-048-07 2,5V

ENT Diagnostic Set complete in case, consisting of:

-
- 1 Battery handle (without batteries)
 - 1 Otoscope head LED, 2,5 V
 - 1 Nasal Specula with Bulb and magnifyer
 - 1 Tongue depressor holder with Bulb
 - 1 Magnifying glass for operation, 4 x
 - 1 Reusable ear Specula, Ø 2,0 | 3,0 | 4,0 | 5,0 mm
 - 3 Disposable ear Specula, Ø 2,5 | 4,0 mm



Diagnostic Sets Juero



Otoscope Set complete in case, consisting of:

-
- 1 Battery handle (without batteries)
 - 1 Otoscope head with Halogen Bulb , 2,5V
 - 1 Reusable ear Specula, Ø 2,0 | 3,0 | 4,0 | 5,0 mm
 - 3 Disposable ear Specula, Ø 2,5 | 4,0 mm
 - 1 Magnifying glass for operation, 4 x
 - 1 Spare Bulb , Halogen, 2,5 V

RI-SCOPE

CH-048-18 2,5V

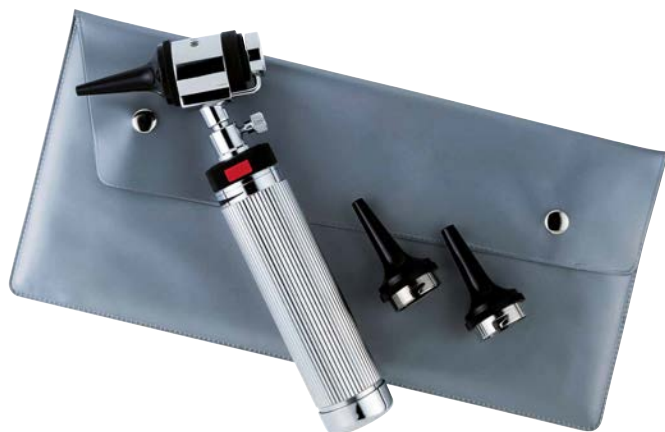

Otoscope Set complete in case, consisting of:

-
- 1 Battery handle (without batteries)
 - 1 Otoscope head with vacuum Bulb , 2,7V
 - 1 Reusable ear Specula, Ø 2,0 | 3,0 | 4,0 mm

UNI I

CH-048-15 2,7V

Ear Curettes, Ear Loops



Ear curettes

Blunt, straight



| | |
|------------------|------------------|
| CH-150-01 | 1,5mm Fig. 000 |
| CH-150-02 | 2,0mm Fig. 00 |
| CH-150-03 | 2,5mm Fig. 0 |
| CH-150-04 | 3,0mm Fig. 1 |
| CH-150-05 | 3,5mm Fig. 2 |
| CH-150-06 | 4,0mm Fig. 3 |
| CH-150-07 | 4,5mm Fig. 4 |
| CH-150-08 | 5,0mm Fig. 5 |

Blunt, angled



| | |
|------------------|------------------|
| CH-151-01 | 1,5mm Fig. 000 |
| CH-151-02 | 2,0mm Fig. 00 |
| CH-151-03 | 2,5mm Fig. 0 |
| CH-151-04 | 3,0mm Fig. 1 |
| CH-151-05 | 3,5mm Fig. 2 |
| CH-151-06 | 4,0mm Fig. 3 |
| CH-151-07 | 4,5mm Fig. 4 |
| CH-151-08 | 5,0mm Fig. 5 |

Sharp, straight



| | |
|------------------|------------------|
| CH-152-01 | 1,5mm Fig. 000 |
| CH-152-02 | 2,0mm Fig. 00 |
| CH-152-03 | 2,5mm Fig. 0 |
| CH-152-04 | 3,0mm Fig. 1 |
| CH-152-05 | 3,5mm Fig. 2 |
| CH-152-06 | 4,0mm Fig. 3 |
| CH-152-07 | 4,5mm Fig. 4 |
| CH-152-08 | 5,0mm Fig. 5 |

Sharp, angled



| | |
|------------------|------------------|
| CH-153-01 | 1,5mm Fig. 000 |
| CH-153-02 | 2,0mm Fig. 00 |
| CH-153-03 | 2,5mm Fig. 0 |
| CH-153-04 | 3,0mm Fig. 1 |
| CH-153-05 | 3,5mm Fig. 2 |
| CH-153-06 | 4,0mm Fig. 3 |
| CH-153-07 | 4,5mm Fig. 4 |
| CH-153-08 | 5,0mm Fig. 5 |

BUCK

CH-150-01 - CH-153-08 17,0 cm, 6 3/4"



Ear loop

Blunt



CH-155-13

LANGENBECK

CH-155-13 13,0 cm, 5 1/8"



Ear loops

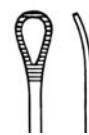

CH-155-16



CH-155-17

SNELLEN

CH-155-16 - CH-155-17 16,0 cm, 6 1/4"

Ear Curettes, Ear Loops

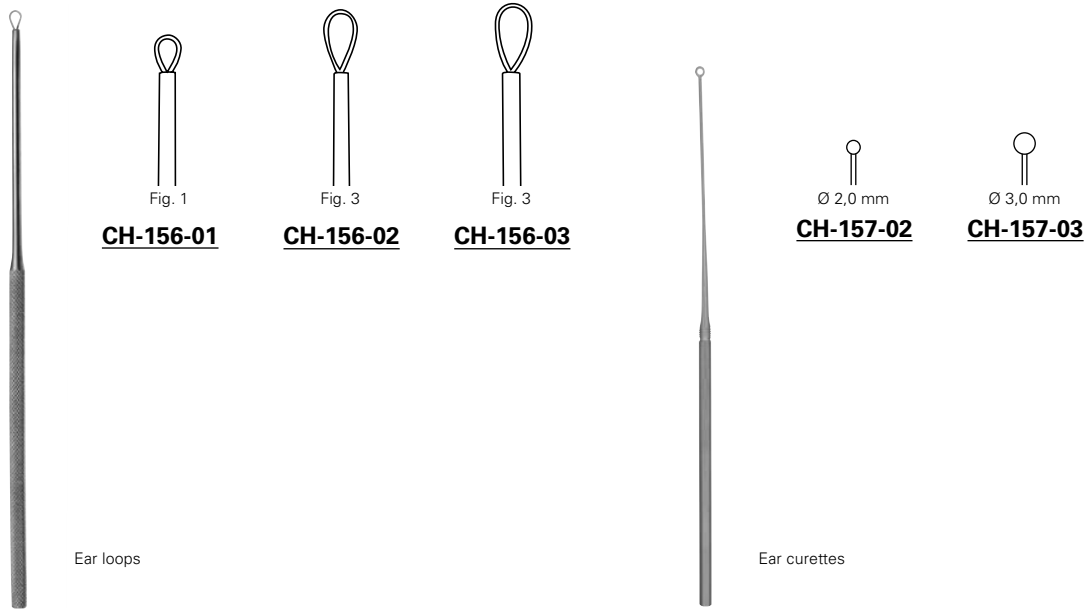

BILLEAU

CH-156-01 - CH-156-03 16,0 cm, 6 ¼"

WEISMAN

CH-157-02 - CH-157-03 14,0 cm, 5 ½"



Ear Curettes, Ear Hooks, Ear Loops

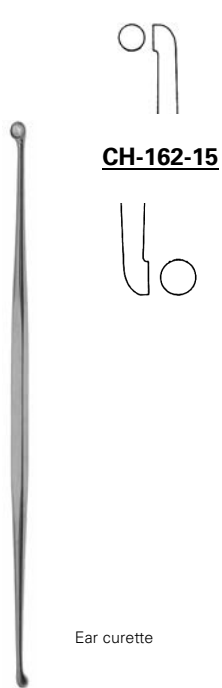

CH-162-15

Ear curette

JANSEN
CH-162-15 15,0 cm, 6 "

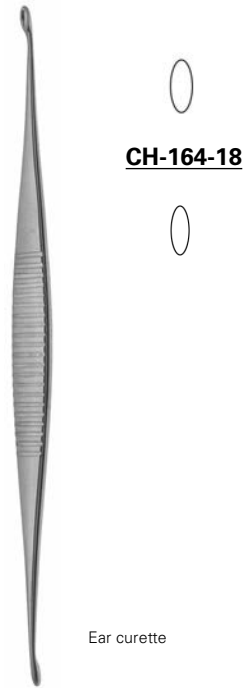

CH-164-18

Ear curette

BARTH
CH-164-18 18,0 cm, 7 "

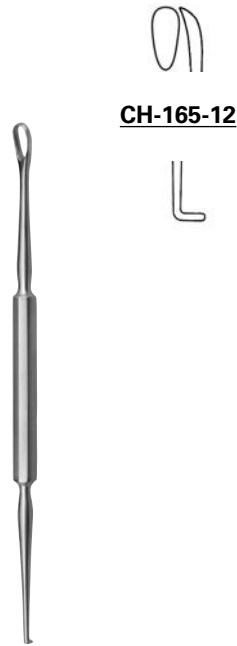

CH-165-12

Cerumen scoop and hook

GROSS
CH-165-12 13,0 cm, 5 "

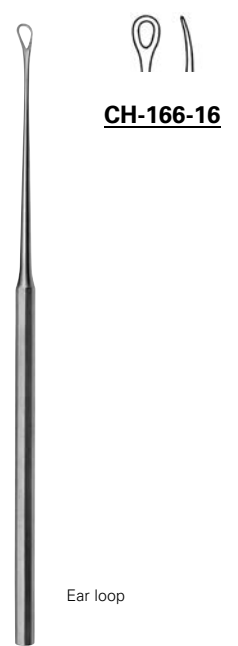

CH-166-16

Ear loop

Cerumen pick and wool carrier

WEBER-LOCH
CH-166-16 16,5 cm, 6 ½ "

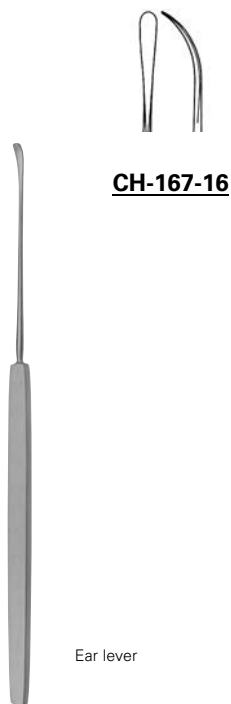

CH-167-16

Ear lever

ZAUFAL
CH-167-16 15,0 cm, 6 "

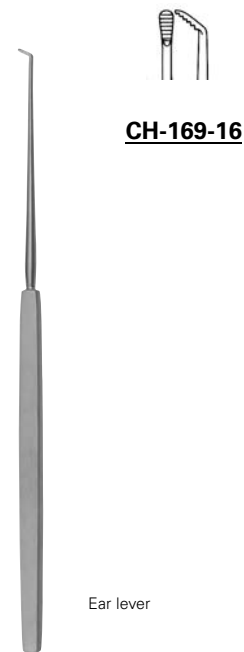

CH-169-16

Ear lever

MOLDENHAUER
CH-169-16 16,0 cm, 6 ¼ "



FORMBY
CH-170-17 18,0 cm, 7 "

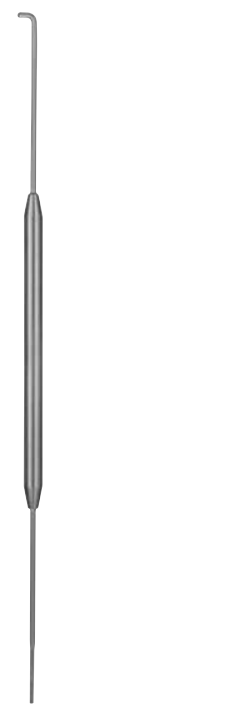

MUSGROVE
CH-172-18 18,0 cm, 7 "

Ear Hooks, Foreign Body Instruments



CH-173-15

Ear hook

ZAUFAL-JANSEN

CH-173-15 15,0 cm, 6"

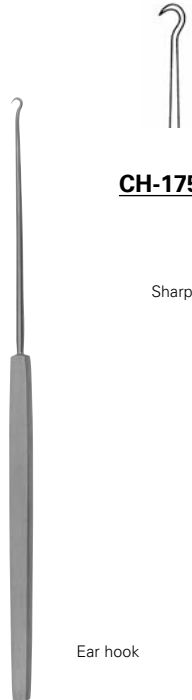

CH-175-16

Sharp

Ear hook

HARTMANN

CH-175-16 16,0 cm, 6 1/4"



Fig. 1

CH-181-01

Fig. 2

CH-181-02

Ear hooks

DAY

CH-181-01 - CH-181-02 17,0 cm, 6 3/4"

Foreign body lever

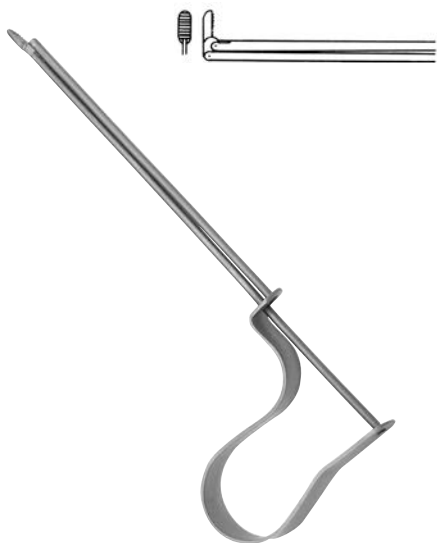

QUIRE

CH-200-09 10,5 cm, 4 1/4"

Foreign body forceps

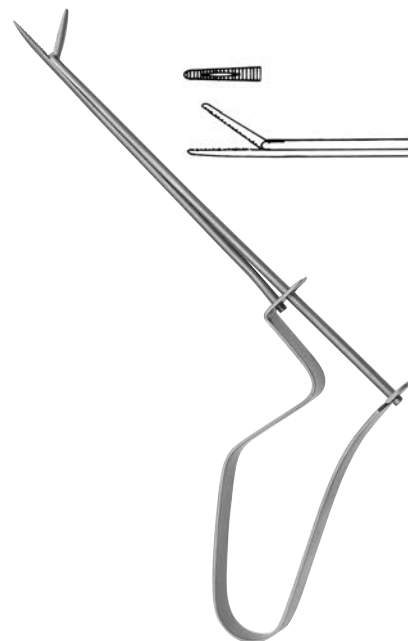

BUCK

CH-200-09 10,5 cm, 4 1/4"

Ear Polypus Forceps



CH-204-12



LITTAUER

CH-204-12 12,0 cm, 4 $\frac{3}{4}$ ''



CH-206-12



HARTMANN

CH-206-12 12,0 cm, 4 $\frac{3}{4}$ ''



CH-208-14



HARTMANN

CH-208-14 14,0 cm, 5 $\frac{1}{2}$ ''



Ear Dressing Forceps

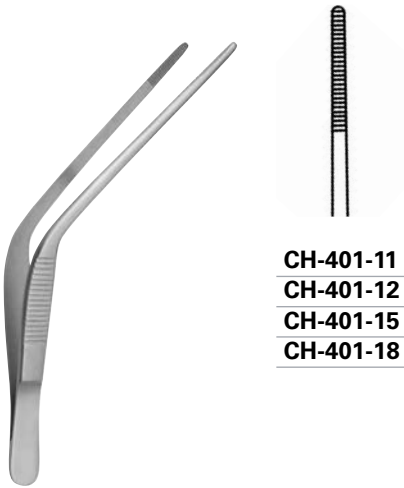

CH-401-11
CH-401-12
CH-401-15
CH-401-18

TROELTSCH

| | |
|------------------|--|
| CH-401-11 | 11,0 cm, 4 ³ / ₈ " |
| CH-401-12 | 12,0 cm, 4 ³ / ₄ " |
| CH-401-15 | 15,0 cm, 6 " |
| CH-401-18 | 18,0 cm, 7 " |

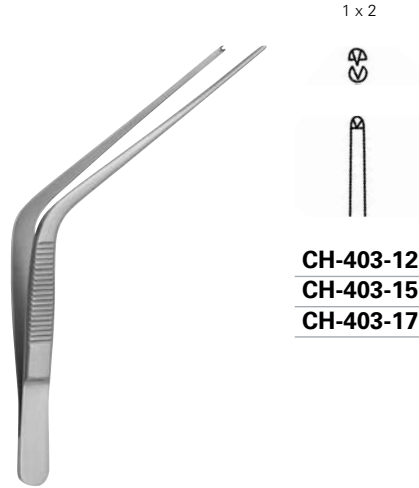

CH-403-12
CH-403-15
CH-403-17

TROELTSCH

| | |
|------------------|--|
| CH-403-12 | 12,0 cm, 4 ³ / ₄ " |
| CH-403-15 | 15,0 cm, 6 " |
| CH-403-17 | 17,0 cm, 6 ³ / ₄ " |

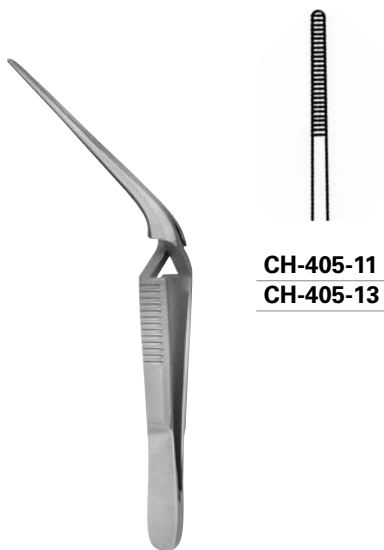

CH-405-11
CH-405-13

TROELTSCH-JALASVIRTA

| | |
|------------------|--|
| CH-405-11 | 11,0 cm, 4 ³ / ₈ " |
| CH-405-13 | 11,0 cm, 4 ¹ / ₈ " |

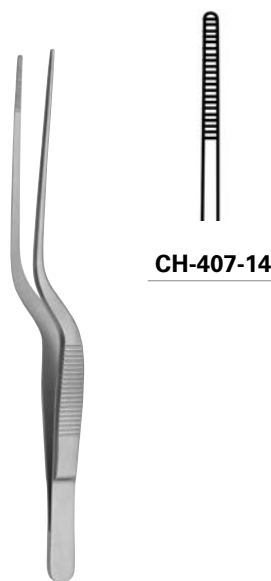

CH-407-14

LUCAE

| | |
|------------------|--|
| CH-407-14 | 14,0 cm, 5 ¹ / ₂ " |
|------------------|--|

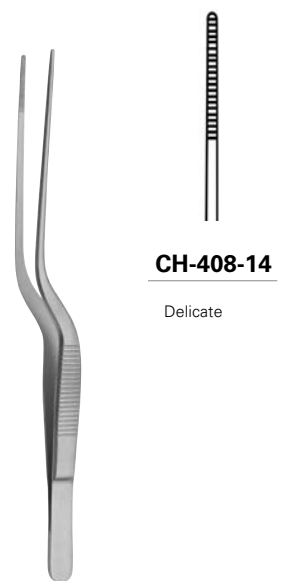

CH-408-14

Delicate

LUCAE

| | |
|------------------|--|
| CH-408-14 | 14,0 cm, 5 ¹ / ₂ " |
|------------------|--|

Ear Dressing Forceps

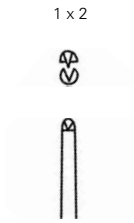

CH-409-14

LUCAE

CH-409-14 14,0 cm, 5 1/2 "

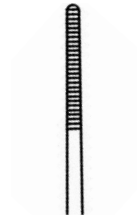

CH-411-16
CH-411-18
CH-411-20

JANSEN

CH-411-16 16,0 cm, 6 1/4 "
CH-411-18 18,0 cm, 7 "
CH-411-20 20,0 cm, 8 "



CH-413-18

GERALD

CH-413-18 18,0 cm, 7 "



CH-415-18

GERALD

CH-415-18 18,0 cm, 7 "



CH-417-20

GRUENWALD-JANSEN

CH-417-20 20,0 cm, 8 "



CH-419-16
CH-419-18
CH-419-20

GRUENWALD-JANSEN

CH-419-16 16,0 cm, 6 1/4 "
CH-419-18 18,0 cm, 7 "
CH-419-20 20,0 cm, 8 "

Ear Polypus Snares



KRAUSE

CH-351-16 18,0 cm, 7 "



KRAUSE-VOSS

CH-353-16 18,0 cm, 7 "



LANGE-WILDE

CH-355-16 16,0 cm, 6 1/4 "



Packing unit: 12 pieces



Packing unit: 100 pieces

Snare wires, coil of 10 m

Snare wires

Snare wires



CH-358-30 Ø 0,3 mm
CH-358-40 Ø 0,4 mm



CH-359-12 Ø 0,2 mm



CH-359-99 Ø 0,2 mm

Periosteal Knives, Myringotome, Tympanum Perforators

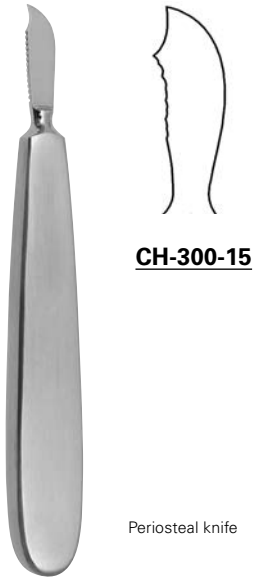

CH-300-15

Periosteal knife

MUCK

CH-300-15 15,0 cm, 6 "

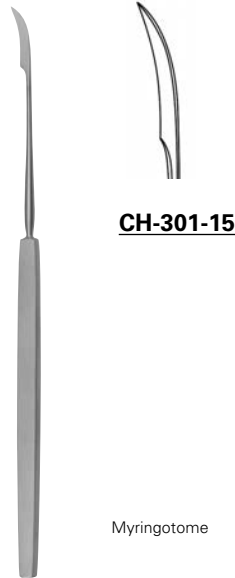

CH-301-15

Myringotome

BUCK

CH-301-15 15,0 cm, 6 "

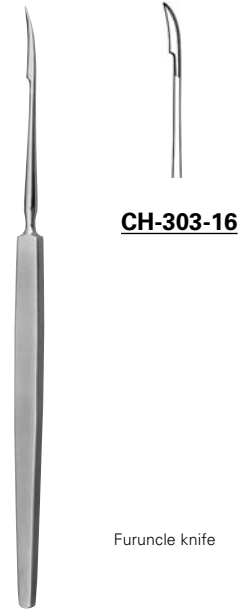

CH-303-16

Furuncle knife

POLITZER

CH-303-16 16,0 cm, 6 ¼ "

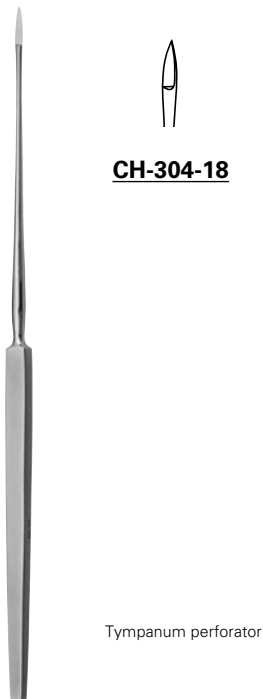

CH-304-18

Tympanum perforator

SEXTON

CH-304-18 18,0 cm, 7 "

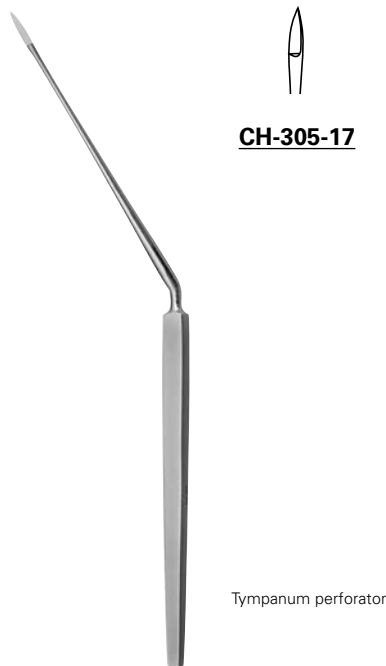

CH-305-17

Tympanum perforator

SEXTON

CH-305-17 17,0 cm, 6 ¾ "

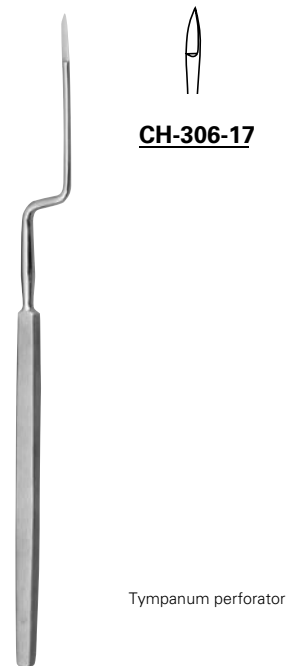

CH-306-17

Tympanum perforator

GERZOG-SEXTON

CH-306-17 17,0 cm, 6 ¾ "

Tympanum Perforators



CH-308-16

Tympanum perforator

POLITZER

CH-308-16 16,5 cm, 6 1/2"



CH-309-16

Tympanum perforator

POLITZER

CH-309-16 16,5 cm, 6 1/2"



CH-310-99

Spare needle

Tympanum perforator

POLITZER

CH-309-17 17,0 cm, 6 3/4"



CH-311-16

Needle diagonally

Tympanum perforator

POLITZER

CH-311-16 16,5 cm, 6 1/2"



CH-311-17

Needle diagonally

Tympanum perforator

POLITZER

CH-311-17 16,5 cm, 6 1/2"

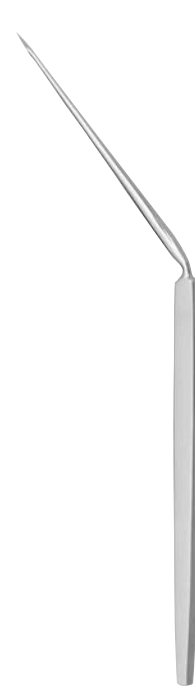

CH-312-17

Tympanum perforator

POLITZER

CH-312-17 17,5 cm, 7 "

Tympanum Perforators

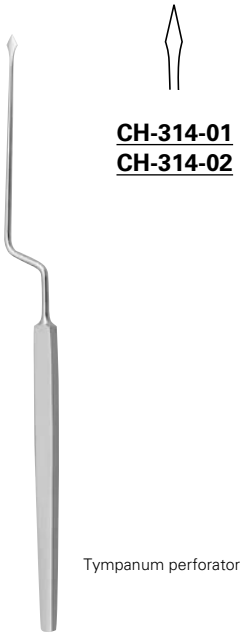

CH-314-01
CH-314-02

Tympanum perforator

LUCAE

CH-314-01 16,0 cm, 6 ¼"
CH-314-02 18,0 cm, 7"

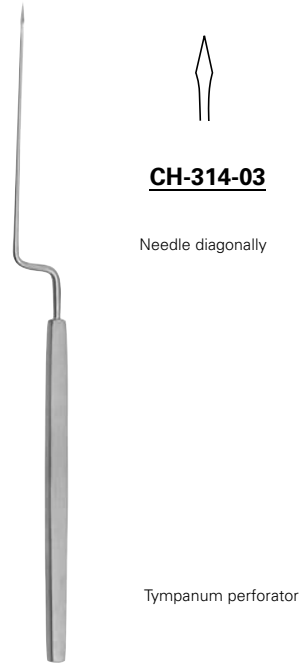

CH-314-03

Needle diagonally

Tympanum perforator

LUCAE

CH-314-03 17,5 cm, 7"



Suction Tubes



WULLSTEIN

CH-900-00 14,0 cm, 5 1/2"

WULLSTEIN

CH-900-01 14,0 cm, 5 1/2"

WULLSTEIN

| | |
|------------------|----------|
| CH-900-04 | Ø 0,4 mm |
| CH-900-06 | Ø 0,6 mm |
| CH-900-08 | Ø 0,9 mm |

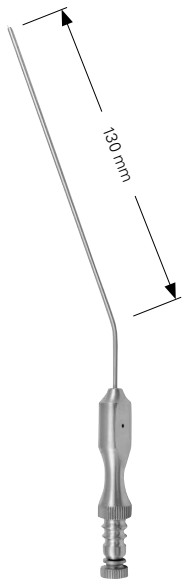

FRAZIER

| | | |
|------------------|----|--------|
| CH-902-06 | 6 | Charr. |
| CH-902-07 | 7 | Charr. |
| CH-902-08 | 8 | Charr. |
| CH-902-09 | 9 | Charr. |
| CH-902-10 | 10 | Charr. |
| CH-902-11 | 11 | Charr. |
| CH-902-12 | 12 | Charr. |
| CH-902-15 | 15 | Charr. |



PLESTER

| | | |
|------------------|----|--------|
| CH-903-05 | 5 | Charr. |
| CH-903-06 | 6 | Charr. |
| CH-903-07 | 7 | Charr. |
| CH-903-08 | 8 | Charr. |
| CH-903-09 | 9 | Charr. |
| CH-903-10 | 10 | Charr. |

Suction and Irrigation Instruments

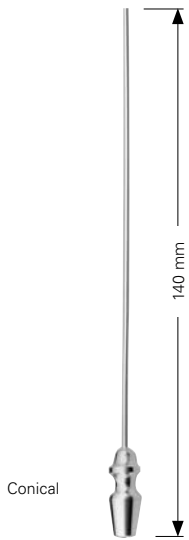

WULLSTEIN

CH-946-01 Ø 1,5 mm



WULLSTEIN

CH-946-02 Ø 1,5 mm

CH-946-03 Ø 2,0 mm

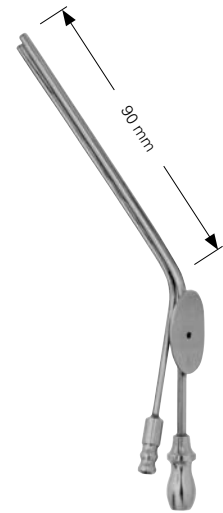

HOUSE

CH-947-07 Ø 0,9 x 0,7 mm

CH-947-09 Ø 1,2 x 0,9 mm

CH-947-12 Ø 1,5 x 1,2 mm

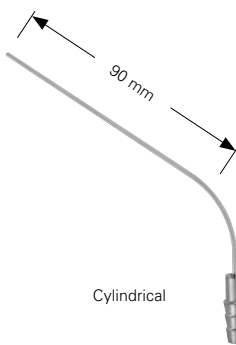

CH-940-10 Ø 1,0 mm

CH-940-15 Ø 1,5 mm

CH-940-20 Ø 2,0 mm

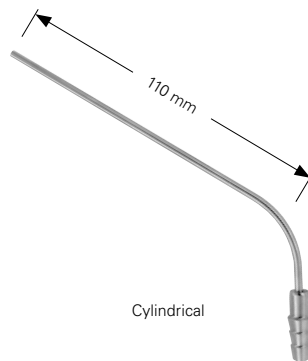

CH-940-25 Ø 2,5 mm

CH-941-30 Ø 3,0 mm

CH-941-40 Ø 4,0 mm

CH-941-50 Ø 5,0 mm

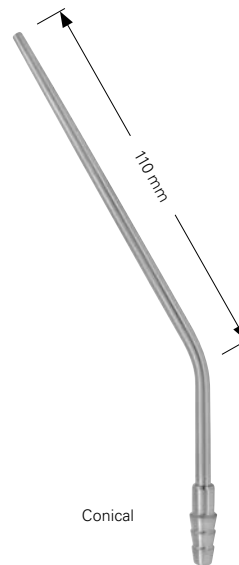

CH-942-03 Ø 3,0 mm

CH-942-04 Ø 3,5 mm

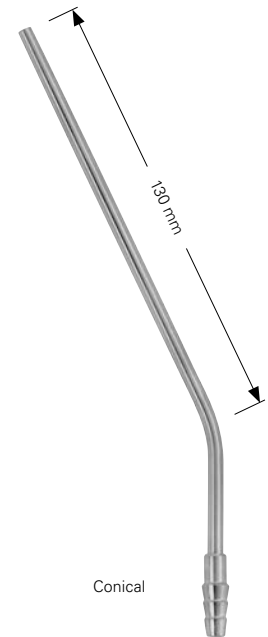

CH-942-05 Ø 4,5 mm

Suction and Irrigation Instruments

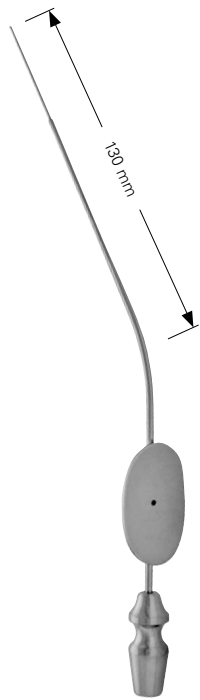

SCHUHKNECHT

| | |
|------------------|----------|
| CH-963-20 | Ø 1,0 mm |
| CH-963-24 | Ø 0,5 mm |

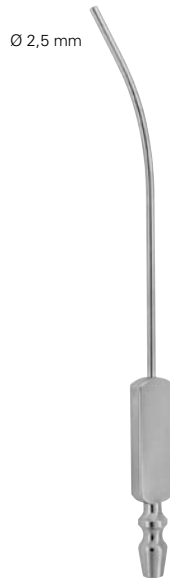

ZOELLNER

| | |
|------------------|-------------|
| CH-964-00 | 15,0 cm, 6" |
|------------------|-------------|

Suction Cannula tips for CH-964-00



ZOELLNER

| | |
|------------------|----------|
| CH-964-05 | Ø 0,5 mm |
| CH-964-07 | Ø 0,7 mm |
| CH-964-09 | Ø 0,9 mm |
| CH-964-12 | Ø 1,2 mm |

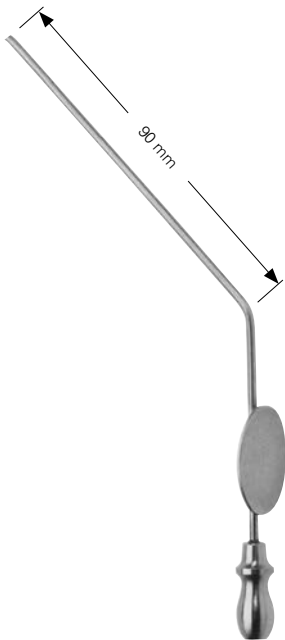

VERHOEVEN 45°

| | |
|------------------|----------|
| CH-965-12 | Ø 1,2 mm |
| CH-965-15 | Ø 1,5 mm |
| CH-965-20 | Ø 2,0 mm |
| CH-965-30 | Ø 3,0 mm |

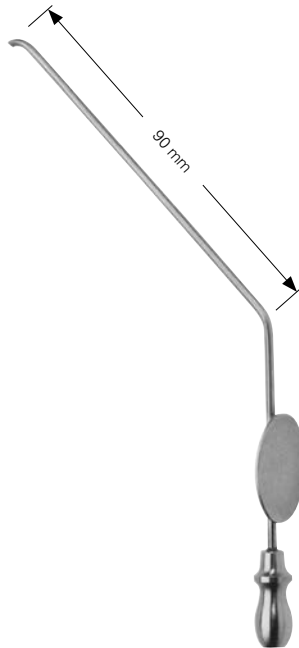

VERHOEVEN 45°

| | |
|------------------|----------|
| CH-966-12 | Ø 1,2 mm |
| CH-966-15 | Ø 1,5 mm |
| CH-966-20 | Ø 2,0 mm |
| CH-966-30 | Ø 3,0 mm |

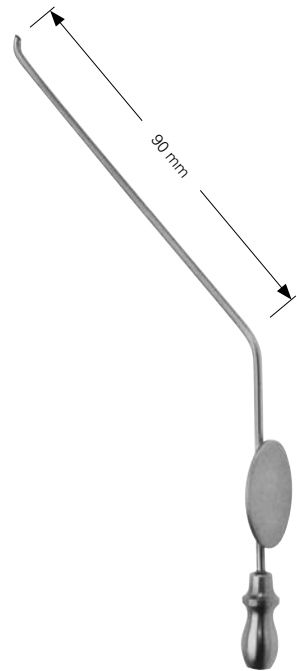

VERHOEVEN 45°

| | |
|------------------|----------|
| CH-967-12 | Ø 1,2 mm |
| CH-967-15 | Ø 1,5 mm |
| CH-967-20 | Ø 2,0 mm |
| CH-967-30 | Ø 3,0 mm |

Elevators

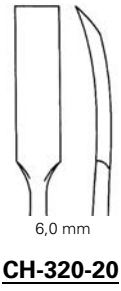
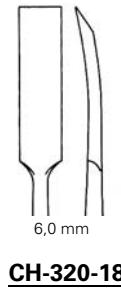
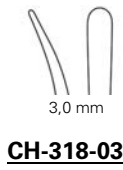

LEMPERT

CH-318-01 - CH-318-03 16,5 cm, 6 ½"

LEMPERT

CH-320-18 18,0 cm, 7"

LEMPERT

CH-320-20 20,5 cm, 8"



Raspatories



12,5 mm

CH-392-14

FARABEUF

CH-392-14 15,0 cm, 6"



12,5 mm

CH-393-14

FARABEUF

CH-393-14 15,0 cm, 6"

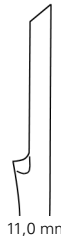

11,0 mm

CH-394-16

FARABEUF-COLLIN

CH-394-16 16,0 cm, 6 3/4"



11,0 mm

CH-395-16

FARABEUF-COLLIN

CH-395-16 16,0 cm, 6 3/4"

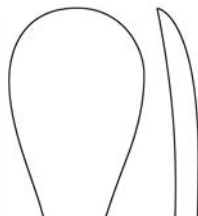

18,0 mm

CH-396-18

SEDILLOT

CH-396-18 18,5 cm, 7 1/4"



10,0 mm

CH-397-01

KRAEMER

CH-397-01 18,5 cm, 7 1/4"



10,0 mm

CH-397-02

KRAEMER

CH-397-02 19,0 cm, 7 1/2"

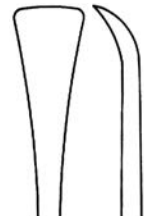

9,5 mm

CH-398-19

BUECHS

CH-398-19 19,0 cm, 7 1/2"

Raspatories



CH-374-01

OBWEGESER

CH-374-01 17,5 cm, 7"

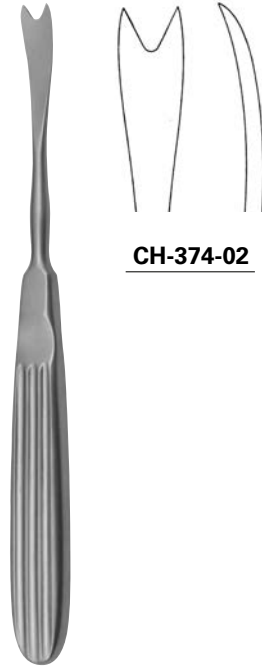

CH-374-02

OBWEGESER

CH-374-02 17,5 cm, 7"

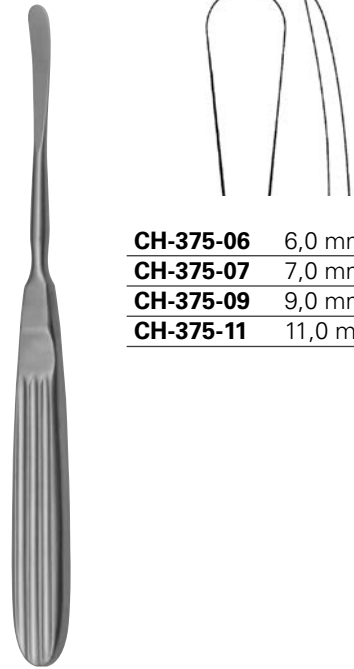

| | |
|------------------|---------|
| CH-375-06 | 6,0 mm |
| CH-375-07 | 7,0 mm |
| CH-375-09 | 9,0 mm |
| CH-375-11 | 11,0 mm |

OBWEGESER

CH-375-06 - CH-375-11 17,5 cm, 7"



CH-376-01

TESSIER

CH-376-01 18,5 cm, 7 ¼"

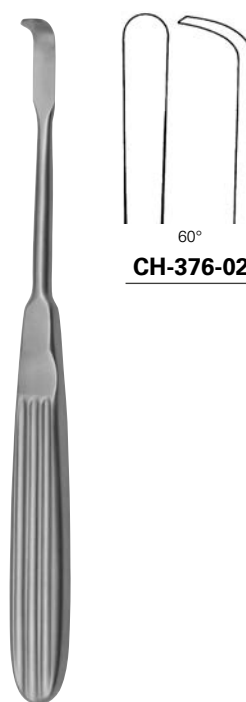

CH-376-02

TESSIER

CH-376-02 18,5 cm, 7 ¼"

Raspatories, Elevators



CH-357-18

Raspatory

MOLT

CH-357-18 18,0 cm, 7"



6,0 mm

CH-358-19

Blunt

Elevator

FREER

CH-358-19 19,0 cm, 7 1/2"



6,0 mm

CH-359-19

Sharp

Elevator

FREER

CH-359-19 19,0 cm, 7 1/2"



3,2 mm

CH-361-16

Raspatory

WULLSTEIN

CH-361-16 16,0 cm, 6 1/4"



2,2 mm

CH-361-17

Raspatory

WULLSTEIN

CH-361-17 16,0 cm, 6 1/4"



7,0 mm

CH-362-16

Raspatory

LEMPERT

CH-362-16 16,0 cm, 6 1/4"



3,0 mm

CH-362-19

Raspatory

LEMPERT

CH-362-19 16,0 cm, 6 1/4"

Chisels, Gouges

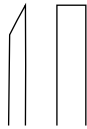

| | |
|------------------|---------|
| CH-265-02 | 2,0 mm |
| CH-265-03 | 3,0 mm |
| CH-265-04 | 4,0 mm |
| CH-265-05 | 5,0 mm |
| CH-265-06 | 6,0 mm |
| CH-265-08 | 8,0 mm |
| CH-265-10 | 10,0 mm |
| CH-265-12 | 12,0 mm |

Chisels

PARTSCH

CH-265-02 - CH-265-12 14,0 cm, 5 ½"

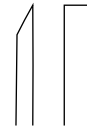

| | |
|------------------|--------|
| CH-266-02 | 2,0 mm |
| CH-266-03 | 3,0 mm |
| CH-266-04 | 4,0 mm |
| CH-266-05 | 5,0 mm |
| CH-266-06 | 6,0 mm |
| CH-266-07 | 7,0 mm |
| CH-266-08 | 8,0 mm |

Chisels

PARTSCH

CH-266-02 - CH-266-08 17,0 cm, 6 ¾"

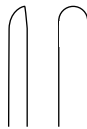

| | |
|------------------|---------|
| CH-267-02 | 2,0 mm |
| CH-267-03 | 3,0 mm |
| CH-267-04 | 4,0 mm |
| CH-267-05 | 5,0 mm |
| CH-267-06 | 6,0 mm |
| CH-267-08 | 8,0 mm |
| CH-267-10 | 10,0 mm |
| CH-267-12 | 12,0 mm |

Gouges

PARTSCH

CH-267-02 - CH-267-12 14,0 cm, 5 ½"

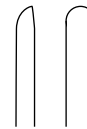

| | |
|------------------|--------|
| CH-268-02 | 2,0 mm |
| CH-268-03 | 3,0 mm |
| CH-268-04 | 4,0 mm |
| CH-268-05 | 5,0 mm |
| CH-268-06 | 6,0 mm |
| CH-268-07 | 7,0 mm |
| CH-268-08 | 8,0 mm |

Gouges

PARTSCH

CH-268-02 - CH-268-08 17,0 cm, 6 ¾"

Chisels, Gouges, Tampers

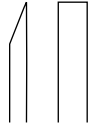

| | |
|------------------|---------|
| CH-271-04 | 4,0 mm |
| CH-271-06 | 6,0 mm |
| CH-271-08 | 8,0 mm |
| CH-271-10 | 10,0 mm |

Chisels

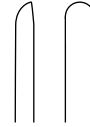

| | |
|------------------|---------|
| CH-272-03 | 3,0 mm |
| CH-272-05 | 5,0 mm |
| CH-272-08 | 8,0 mm |
| CH-272-10 | 10,0 mm |

Gouge

BRUENINGS-LUCAS

CH-271-04 - CH-271-10 16,0 cm, 6 ¼"

BRUENINGS-LUCAS

CH-272-03 - CH-272-10 16,0 cm, 6 ¼"



| | |
|------------------|--------|
| CH-250-25 | 2,5 mm |
| CH-250-35 | 3,5 mm |

PASSOW

CH-250-25 - CH-250-35 12,0 cm, 4 ¾"



| | |
|------------------|-----------|
| CH-251-02 | Ø 2,0 mm |
| CH-251-03 | Ø 3,0 mm |
| CH-251-04 | Ø 4,0 mm |
| CH-251-05 | Ø 5,0 mm |
| CH-251-06 | Ø 6,0 mm |
| CH-251-08 | Ø 8,0 mm |
| CH-251-10 | Ø 10,0 mm |

CH-251-02 - CH-251-10 16,0 cm, 6 ¼"

Mallets



HW Head weight

TW Total weight



HW 320 g
TW 420 g
Ø 26,0 mm
CH-200-22

Spare discs

MEAD

CH-200-20 19,0 cm, 7 ½ "



HW 140 g
TW 240 g
Ø 25,0 mm
CH-201-99

Spare discs

MEAD

CH-201-25 18,5 cm, 7 ¼ "



HW 240 g
TW 340 g
Ø 30,0 mm
CH-202-30

1 side flat
1 side convex

COTTLE

CH-202-30 19,0 cm, 7 ½ "



HW 100 g
TW 140 g
Ø 20,0 mm
CH-203-22

Lead filled head

CH-203-22 16,5 cm, 6 ½ "



HW 160 g
TW 220 g
Ø 22,0 mm
CH-204-22

Lead filled head

CH-204-22 19,0 cm, 7 ½ "



HW 160 g
TW 220 g
Ø 27,0 mm
CH-205-27

HAJEK

CH-205-27 20,0 cm, 8 "

Bone Currettes

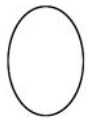

Fig. 5

CH-468-09

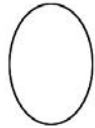

Fig. 6

CH-468-10



Fig. 5

CH-468-18



Fig. 6

CH-468-19



Fig. 3

CH-468-07

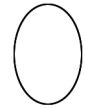

Fig. 4

CH-468-08



Fig. 3

CH-468-16



Fig. 4

CH-468-17



Fig. 1

CH-468-05



Fig. 2

CH-468-06



Fig. 1

CH-468-14



Fig. 2

CH-468-15



Fig. 00

CH-468-03



Fig. 0

CH-468-04



Fig. 00

CH-468-12



Fig. 0

CH-468-13



Fig. 0000

CH-468-01



Fig. 000

CH-468-02



Fig. 000

CH-468-11



SPRATT

CH-468-01 - CH-468-10 17,0 cm, 6 ³/₄ "



SPRATT

CH-468-11 - CH-468-19 20,0 cm, 8 "

Rongeurs

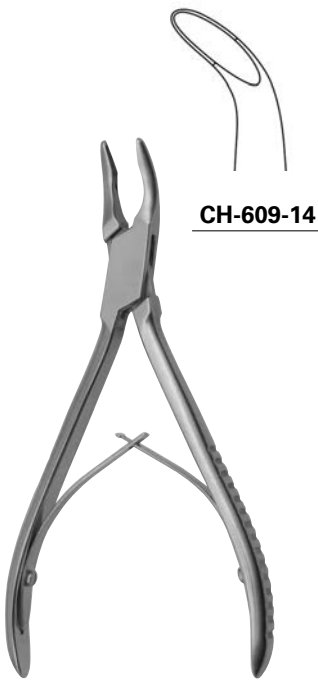

CH-609-14

CH-609-14 14,0 cm, 5 1/2"



CH-611-01

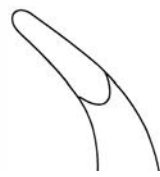

CH-611-02

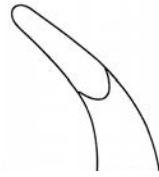

CH-611-03

LUER

CH-611-01 - CH-611-03 15,0 cm, 6"

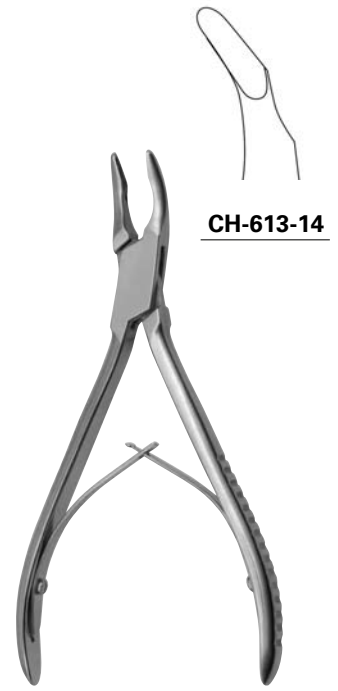

CH-613-14

CLEVELAND

CH-613-14 14,0 cm, 5 1/2"



CH-622-16
CH-622-20



CH-623-16
CH-623-20

LEMPERT

CH-622-16 - CH-623-16 16,0 cm, 6 1/4"
CH-622-20 - CH-623-20 20,0 cm, 8"



CH-625-18

BEYER

CH-625-18 18,0 cm, 7"

Rongeurs

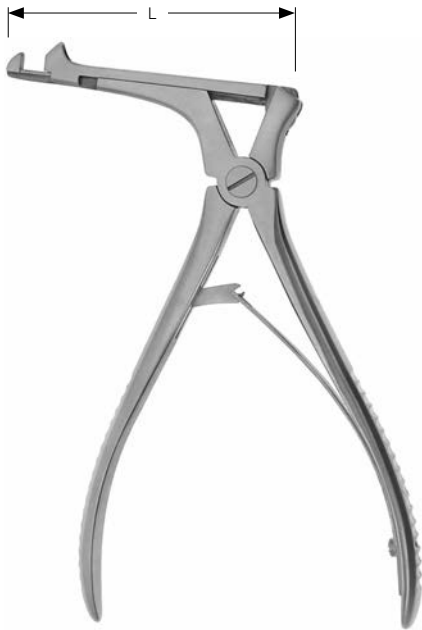

1,0 mm
CH-000-15

2,0 mm
CH-000-22

3,0 mm
CH-000-30
90° cutting upwards

CITELLI

CH-000-15 - CH-000-30 6,5 cm, 2 1/2"

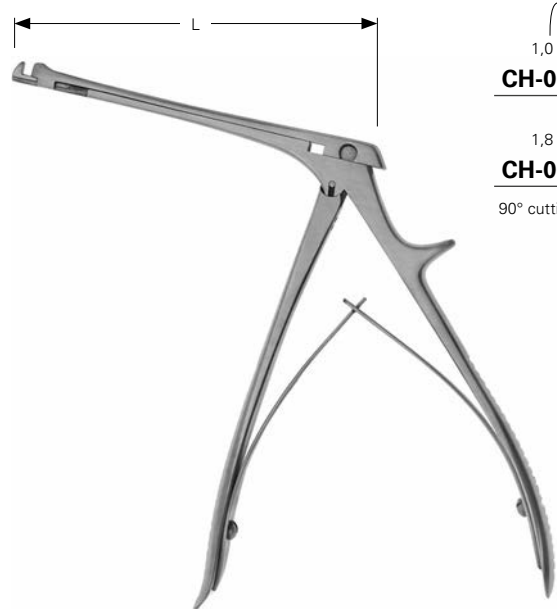

1,0 mm
CH-002-10

1,8 mm
CH-002-18
90° cutting upwards

CITELLI-BEYER

CH-002-10 - CH-002-18 9,5 cm, 3 3/4"

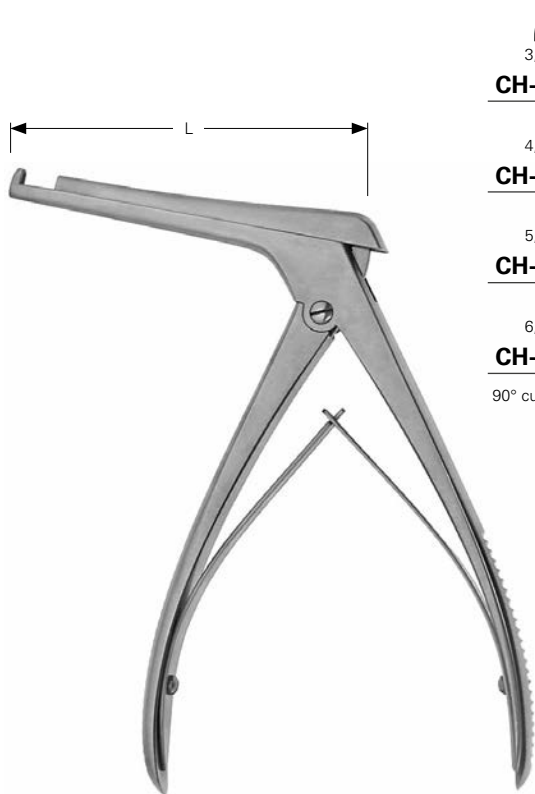

3,0 mm
CH-004-03

4,0 mm
CH-004-04

5,0 mm
CH-004-05

6,0 mm
CH-004-06
90° cutting upwards

KERRISON

CH-004-03 - CH-004-06 9,0 cm, 3 1/2"



CH-005-20

HAJEK-CLAUS

CH-005-20 20,0 cm, 8"

Micro Ear Knives, Micro Instruments



CH-500-01 - CH-502-02 16,0 cm, 6 ¼"

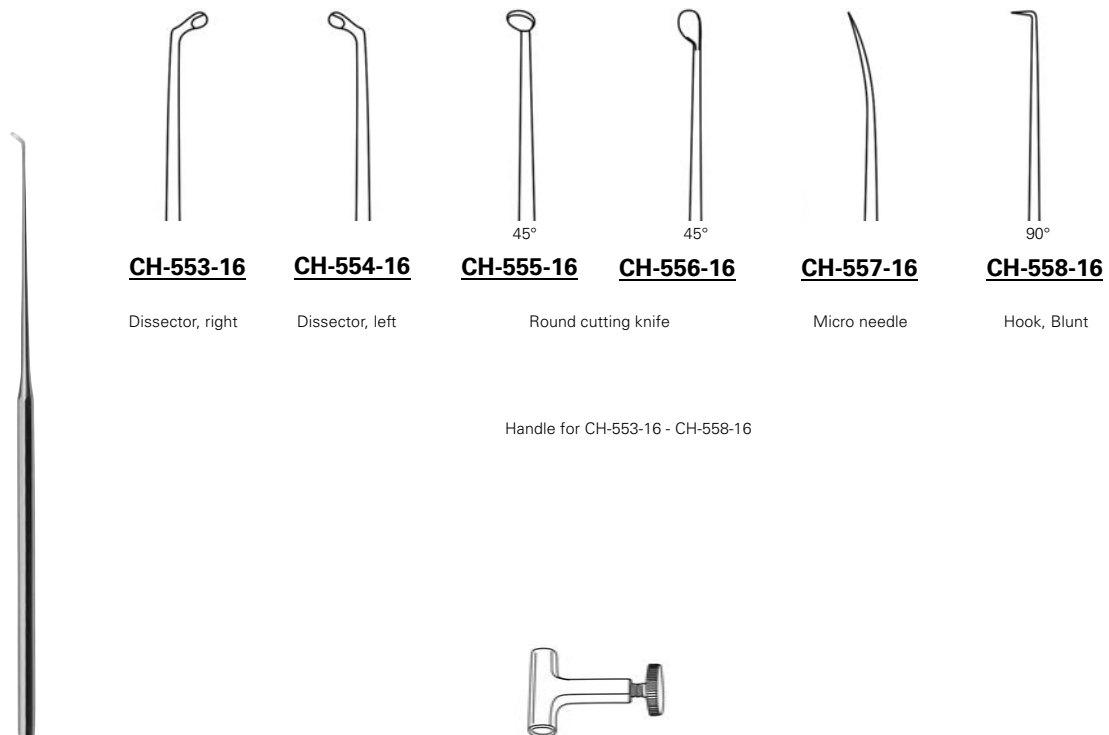

CH-553-16 - CH-558-16 16,0 cm, 6 ¼"

CH-559-00

Micro Knives



CH-500-01

Discision knife



PLESTER

CH-500-02

Sickle knife



TABB

CH-500-04

Mucosa knife



BEALES

CH-500-05

Tendon knife



CH-500-06

Sickle knife



PLESTER

CH-500-12

Sickle knife



PLESTER

CH-500-13

Sickle knife



PLESTER

CH-500-15

Sickle knife



2,4 x 3,0 mm

PLESTER

CH-501-01

Flap knife



2,4 x 3,5 mm

PLESTER

CH-501-02

Flap knife

CH-500-01 - CH-502-02 16,0 cm, 6 1/4"



Micro Instruments

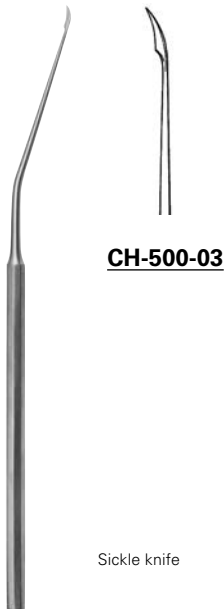

CH-500-03

Sickle knife

SCHUKNECHT

CH-500-03 16,0 cm, 6 1/4 "

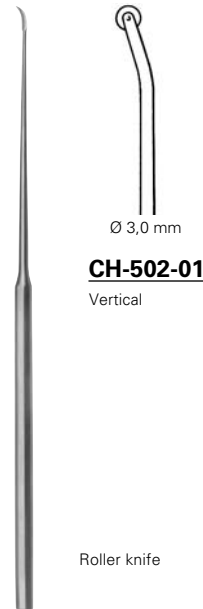

Ø 3,0 mm

CH-502-01

Vertical

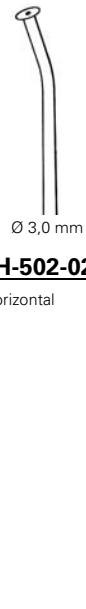

Ø 3,0 mm

CH-502-02

Horizontal

SCHUKNECHT

CH-502-01 - CH-502-02 16,0 cm, 6 1/4 "



45°

| | |
|------------------|----------|
| CH-503-01 | Ø 3,5 mm |
| CH-503-02 | Ø 3,0 mm |
| CH-503-03 | Ø 2,8 mm |
| CH-503-04 | Ø 2,6 mm |
| CH-503-05 | Ø 2,3 mm |
| CH-503-06 | Ø 2,0 mm |
| CH-503-07 | Ø 1,6 mm |
| CH-503-08 | Ø 1,4 mm |
| CH-503-09 | Ø 1,0 mm |



90°

| | |
|------------------|----------|
| CH-503-12 | Ø 3,0 mm |
| CH-503-13 | Ø 2,5 mm |
| CH-503-14 | Ø 2,3 mm |
| CH-503-15 | Ø 2,0 mm |
| CH-503-16 | Ø 1,5 mm |
| CH-503-18 | Ø 1,0 mm |



| | |
|------------------|----------|
| CH-503-22 | Ø 3,0 mm |
| CH-503-23 | Ø 2,5 mm |
| CH-503-24 | Ø 2,3 mm |
| CH-503-25 | Ø 2,0 mm |
| CH-503-26 | Ø 1,5 mm |
| CH-503-28 | Ø 1,0 mm |

Round cutting knives

ROSEN

CH-503-01 - CH-503-28 16,0 cm, 6 1/4 "

Micro Instruments

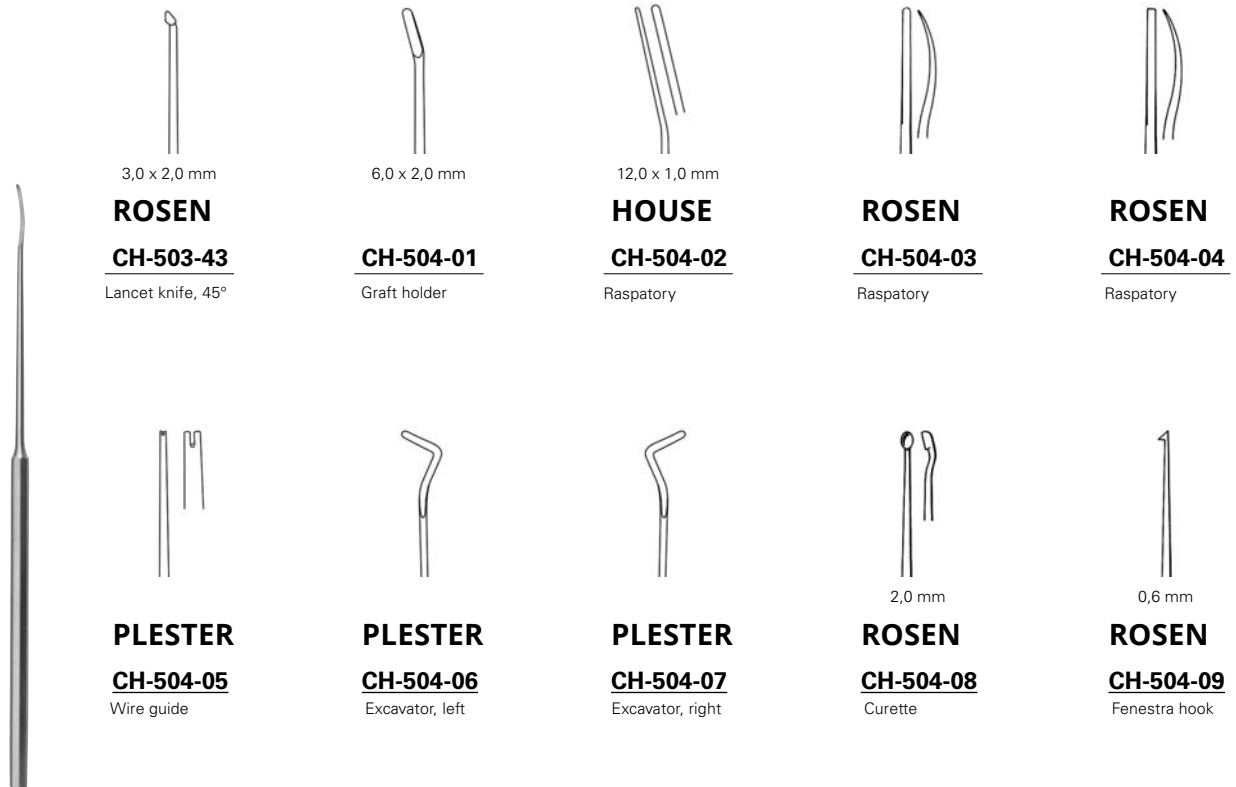

CH-503-43 - 57-504-09 16,0 cm, 6 1/4"

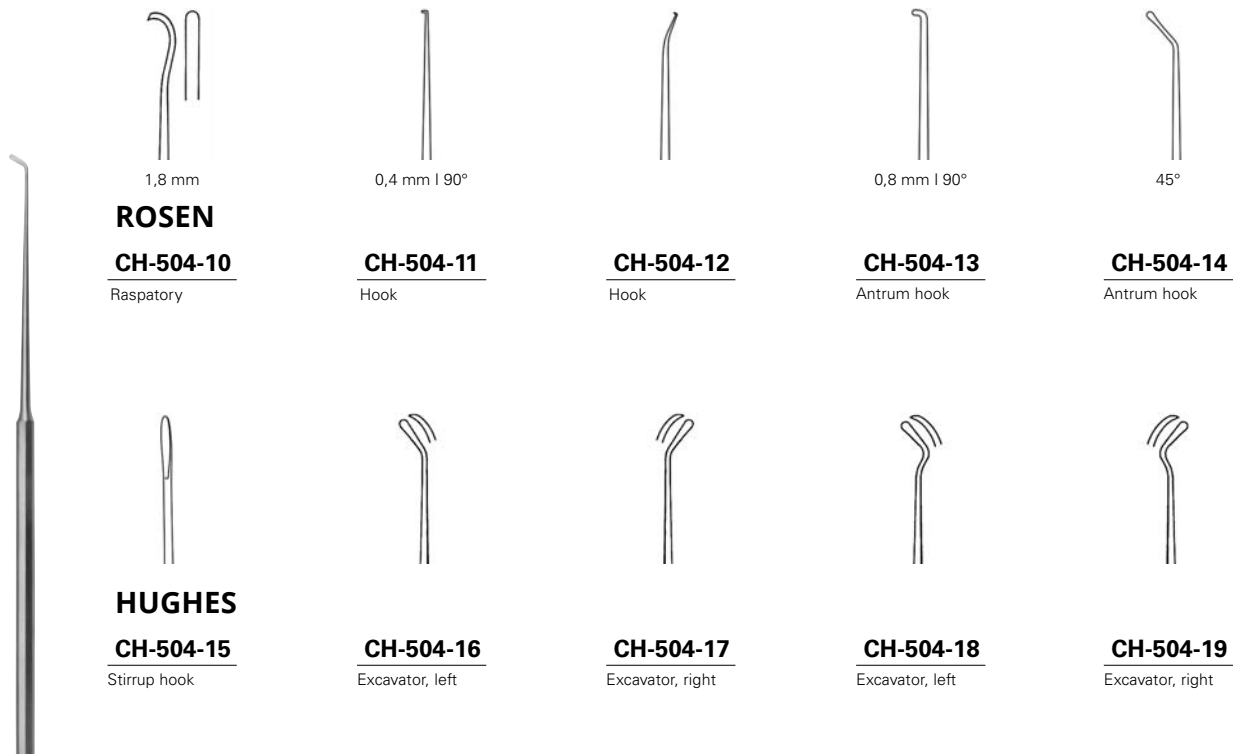

CH-504-10 - CH-504-19 16,0 cm, 6 1/4"

Micro Instruments



CH-504-20
Sickle knife



0,2 mm | 90°
PLESTER
CH-504-22
Antrum hook



3,5 | 4,0 | 4,5 mm
CH-508-00
Measuring rod



BARBARA
CH-510-01
Micro needle



BARBARA
CH-510-02
Micro needle



BARBARA
CH-510-03
Micro needle



ROSEN
CH-510-04
Micro needle

CH-504-20 - CH-510-04 16,0 cm, 6 1/4"



2,0 mm
PLESTER
CH-510-17
Scraper, 60°



BEALE
CH-510-64
Hook



90°
HOUSE
CH-506-35 L = 3,5 mm
CH-506-40 L = 4,0 mm
CH-506-45 L = 4,5 mm
CH-506-50 L = 5,0 mm
Micro needles



CH-509-03 0,3 mm
CH-509-04 0,4 mm
CH-509-05 0,5 mm
CH-509-06 0,6 mm
Perforators

CH-510-17 - CH-510-64 16,0 cm, 6 1/4"

CH-506-35 - CH-509-06 16,0 cm, 6 1/4"

Micro Instruments





Micro hooks

| | | | | | |
|------------------|--------|------------------|--------|------------------|--------|
| | 25° | | 45° | | 90° |
| CH-510-05 | 0,3 mm | CH-510-08 | 0,4 mm | CH-510-12 | 0,4 mm |
| CH-510-06 | 0,6 mm | CH-510-09 | 0,6 mm | CH-510-32 | 0,5 mm |
| CH-510-07 | 1,0 mm | CH-510-10 | 0,8 mm | CH-510-13 | 0,6 mm |
| | | CH-510-11 | 1,0 mm | CH-510-14 | 0,8 mm |
| | | CH-510-18 | 1,5 mm | CH-510-15 | 1,0 mm |
| | | CH-510-19 | 2,0 mm | CH-510-25 | 1,2 mm |
| | | CH-510-20 | 2,5 mm | CH-510-26 | 1,5 mm |
| | | | | CH-510-27 | 2,0 mm |
| | | | | CH-510-28 | 2,5 mm |
| | | | | CH-510-29 | 3,0 mm |
| | | | | CH-510-30 | 4,0 mm |
| | | | | CH-510-31 | 5,0 mm |

SHAMBAUGH

CH-510-05 - CH-510-32 16,0 cm, 6 ¼"



Micro hooks

| | | | |
|------------------|--------|------------------|------------------|
| | | | |
| CH-510-21 | 0,5 mm | BARBARA | ROSEN |
| CH-510-16 | 1,0 mm | CH-514-01 | CH-515-01 |

Curved retrograde



Micro needles

SHAMBAUGH

CH-510-16 - CH-510-21 16,0 cm, 6 ¼"

CH-514-01 - CH-515-01 16,0 cm, 6 ¼"

Micro Instruments

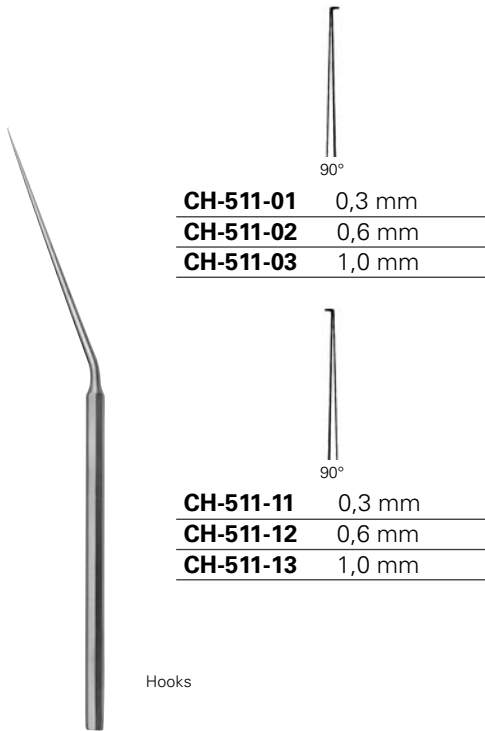

CH-511-01 - CH-511-13 16,0 cm, 6 ¼"

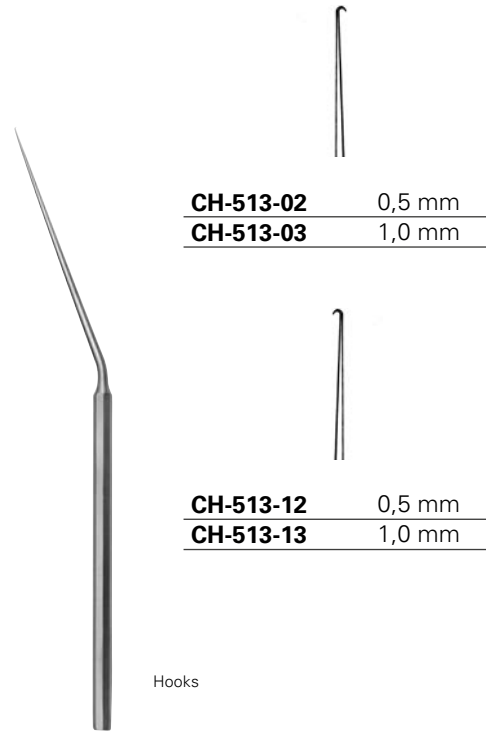

MC GEE

CH-513-02 - CH-513-13 16,0 cm, 6 ¼"

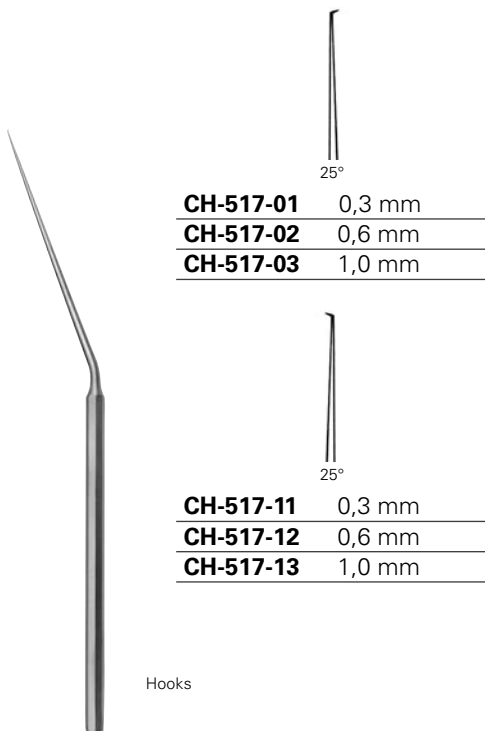

CH-517-01 - CH-517-13 16,0 cm, 6 ¼"

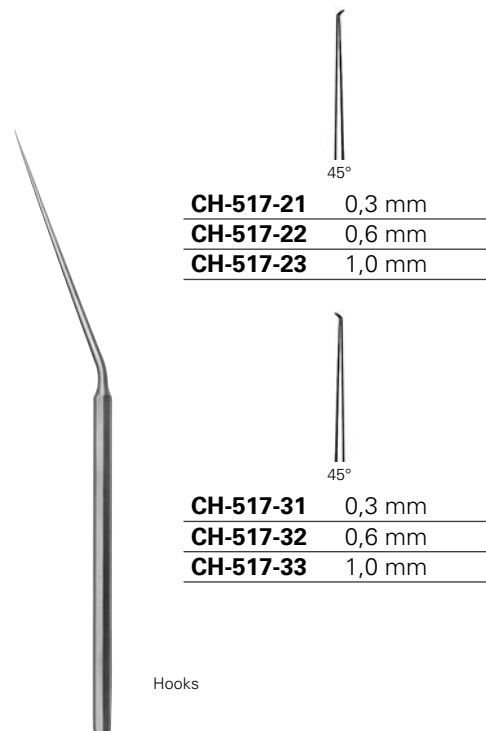

CH-517-21 - CH-517-33 16,0 cm, 6 ¼"

Micro Instruments

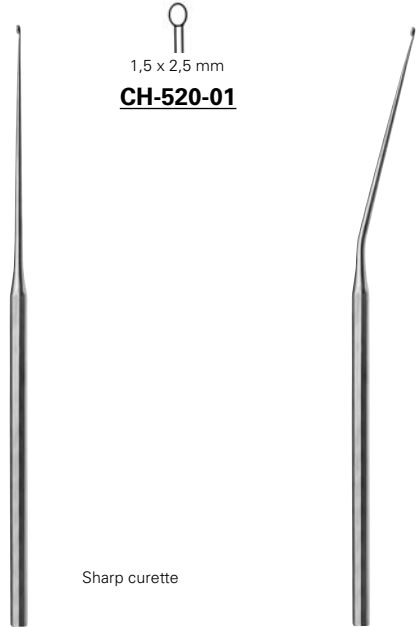

1,5 x 2,5 mm
CH-520-01

Sharp curette

1,5 x 2,5 mm
CH-521-01

Sharp curette

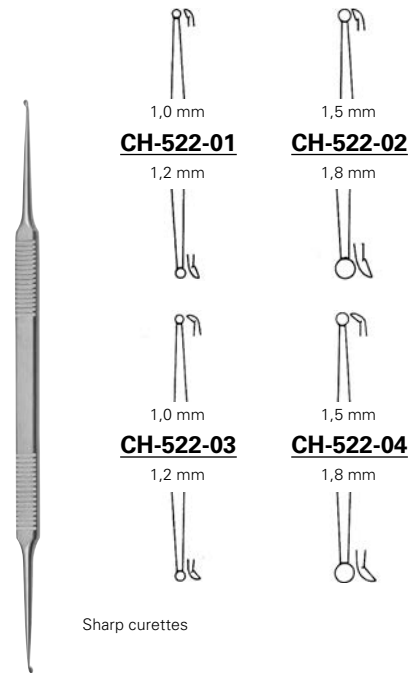

1,0 mm
CH-522-01
1,2 mm

Sharp currettes

1,5 mm
CH-522-02
1,8 mm

1,0 mm
CH-522-03
1,2 mm

1,5 mm
CH-522-04
1,8 mm

SHEA

CH-520-01 16,0 cm, 6 ¼"

SHEA

CH-521-01 16,0 cm, 6 ¼"

HOUSE

CH-522-01 - CH-522-04 16,0 cm, 6 ¼"



CH-530-01 0,7 mm
Chisel

Handle for CH-530-01 - CH-530-05



CH-530-02 0,7 mm
CH-530-03 1,0 mm
CH-530-04 1,5 mm
CH-530-05 3,0 mm
Gouge



Chrome-plated



Mallet, metal

HERMANN

27-530-01 - 27-530-05 9,0 cm, 3 ½"

HERMANN

CH-529-00 9,0 cm, 3 ½"

HERMANN

CH-532-19 19,5 cm, 7 ¾"

Micro Instruments



CH-553-16 - CH-558-16 16,0 cm, 6 1/4"



CH-553-16
Dissector, right



CH-554-16
Dissector, left



CH-555-16
45°
Round cutting knife



CH-556-16
45°



CH-55716
Micro needle



CH-558-16
90°
Hook, Blunt

Handle for CH-553-16 - CH-558-16



CH-559-00

Preparation plate, glass



CH-590-00 95 x 70 x 4 mm



Micro Instruments

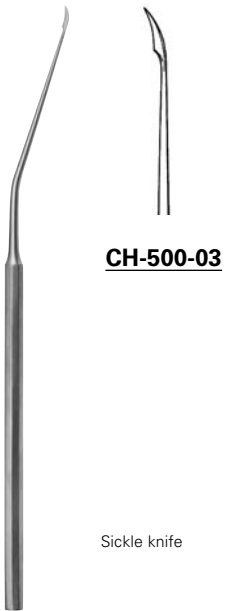

CH-500-03

Sickle knife

SCHUKNECHT

CH-500-03 16,0 cm, 6 1/4 "

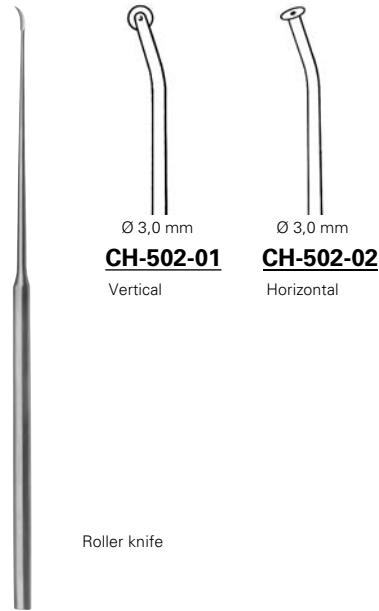

Ø 3,0 mm

CH-502-01

Vertical

Ø 3,0 mm

CH-502-02

Horizontal

Roller knife

SCHUKNECHT

CH-502-01 - CH-502-02 16,0 cm, 6 1/4 "

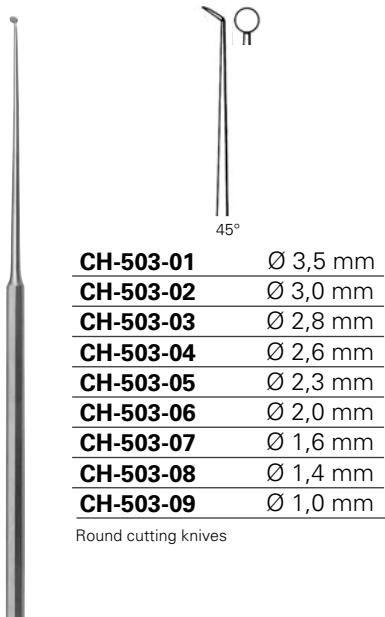

- | | |
|------------------|----------|
| CH-503-01 | Ø 3,5 mm |
| CH-503-02 | Ø 3,0 mm |
| CH-503-03 | Ø 2,8 mm |
| CH-503-04 | Ø 2,6 mm |
| CH-503-05 | Ø 2,3 mm |
| CH-503-06 | Ø 2,0 mm |
| CH-503-07 | Ø 1,6 mm |
| CH-503-08 | Ø 1,4 mm |
| CH-503-09 | Ø 1,0 mm |

Round cutting knives



45°



90°

- | | |
|------------------|----------|
| CH-503-12 | Ø 3,0 mm |
| CH-503-13 | Ø 2,5 mm |
| CH-503-14 | Ø 2,3 mm |
| CH-503-15 | Ø 2,0 mm |
| CH-503-16 | Ø 1,5 mm |
| CH-503-18 | Ø 1,0 mm |

- | | |
|------------------|----------|
| CH-503-22 | Ø 3,0 mm |
| CH-503-23 | Ø 2,5 mm |
| CH-503-24 | Ø 2,3 mm |
| CH-503-25 | Ø 2,0 mm |
| CH-503-26 | Ø 1,5 mm |
| CH-503-28 | Ø 1,0 mm |

ROSEN

CH-503-01 - CH-503-28 16,0 cm, 6 1/4 "

Micro Ear Forceps, Micro Cup-shaped Forceps

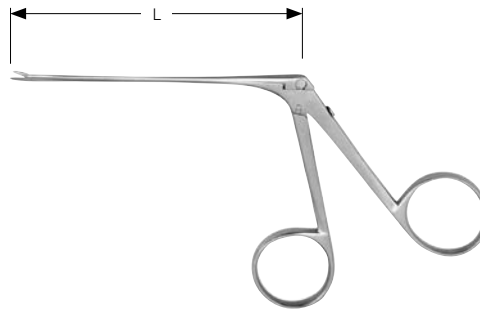

L = 8,0 cm, 3 1/8"

CH-400-01 4,0 x 0,8 mm
CH-402-01 4,0 x 0,6 mm
CH-404-01 3,5 x 0,6 mm

Smooth, straight



L = 8,0 cm, 3 1/8"

CH-400-02 4,0 x 0,8 mm
CH-402-02 4,0 x 0,6 mm
CH-404-02 3,5 x 0,6 mm

Serrated, straight

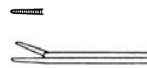

L = 12,5 cm, 5"

CH-400-12 4,0 x 0,8 mm
CH-402-12 4,0 x 0,6 mm

Serrated, straight



L = 8,0 cm, 3 1/8"

CH-400-03 4,0 x 0,8 mm
CH-402-03 4,0 x 0,6 mm

Serrated, curved upwards



L = 8,0 cm, 3 1/8"

CH-400-04 4,0 x 0,8 mm
CH-402-04 4,0 x 0,6 mm

Serrated, right



L = 8,0 cm, 3 1/8"

CH-400-05 4,0 x 0,8 mm
CH-402-05 4,0 x 0,6 mm

Serrated, left

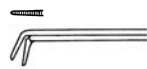

L = 8,0 cm, 3 1/8"

CH-400-06 4,0 x 0,8 mm

Serrated, curved downwards

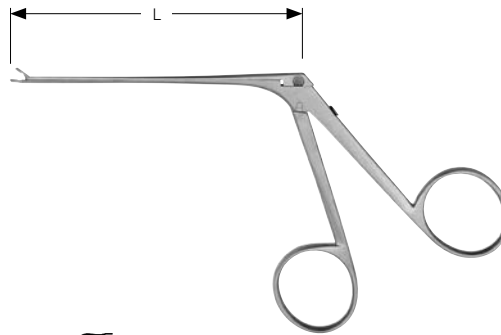

WULLSTEIN



L = 12,5 cm, 5"

CH-406-00 Ø 1,0 mm

Straight, round



L = 8,0 cm, 3 1/8"

CH-405-01 1,5 x 0,8 mm
CH-406-01 1,0 x 0,9 mm
CH-408-01 0,6 x 0,5 mm

Straight, oval

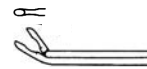

L = 8,0 cm, 3 1/8"

CH-406-02 1,0 x 0,9 mm
CH-408-02 0,6 x 0,5 mm

Curved upwards, oval



L = 8,0 cm, 3 1/8"

CH-405-03 1,5 x 0,8 mm
CH-406-03 1,0 x 0,9 mm
CH-408-03 0,6 x 0,5 mm

Right, oval



L = 8,0 cm, 3 1/8"

CH-406-04 1,0 x 0,9 mm
CH-408-04 0,6 x 0,5 mm

Left, oval



L = 8,0 cm, 3 1/8"

CH-406-05 1,0 x 0,9 mm
CH-408-05 0,6 x 0,5 mm

Curved downwards, oval

Micro Ear Scissors

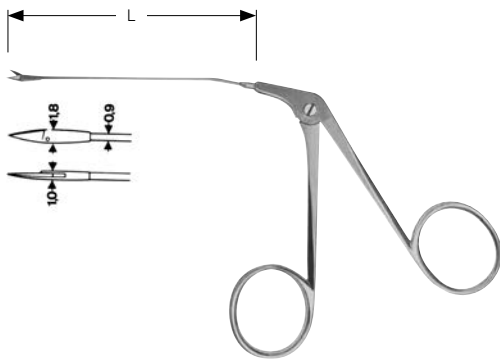

 L = 8,0 cm, 3 1/8"

CH-409-01 1,0 x 1,8 mm
Right With tubular shaft

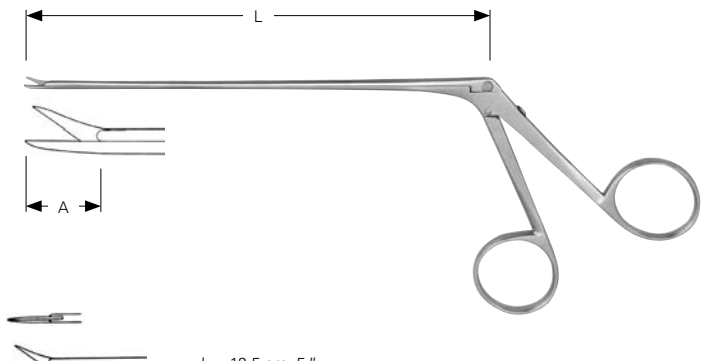

BELLUCCI

CH-412-11 A = 4,5 mm
Straight

 L = 12,5 cm, 5"

 L = 8,0 cm, 3 1/8"

CH-409-02 1,0 x 1,8 mm
Left With tubular shaft

 L = 15,0 cm, 6"

BELLUCCI

CH-412-15 A = 4,5 mm
Straight

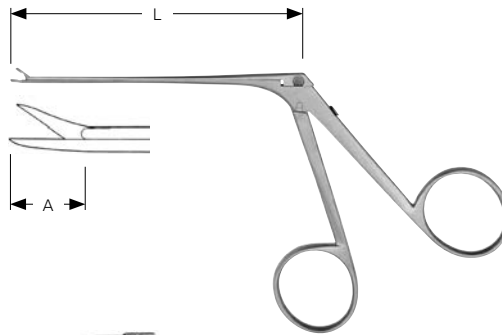

BELLUCCI

 L = 8,0 cm, 3 1/8"

CH-410-01 A = 8,0 mm
CH-412-01 A = 4,5 mm
CH-414-01 A = 3,5 mm
Straight

 L = 8,0 cm, 3 1/8"

CH-410-02 A = 6,0 mm
CH-412-02 A = 4,0 mm
Curved upwards

 L = 8,0 cm, 3 1/8"

CH-410-03 A = 8,0 mm
CH-412-03 A = 4,5 mm
CH-414-03 A = 3,5 mm
Right

 L = 8,0 cm, 3 1/8"

CH-410-04 A = 8,0 mm
CH-412-04 A = 4,5 mm
CH-414-04 A = 3,5 mm
Left

Micro Wire Bending Forceps

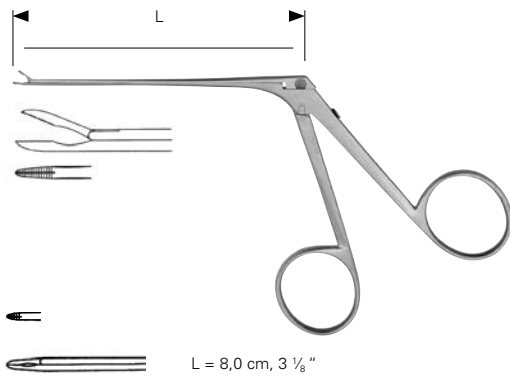

L = 8,0 cm, 3 1/8"

GREVEN

CH-420-01 0,8 x 5,0 mm
Straight

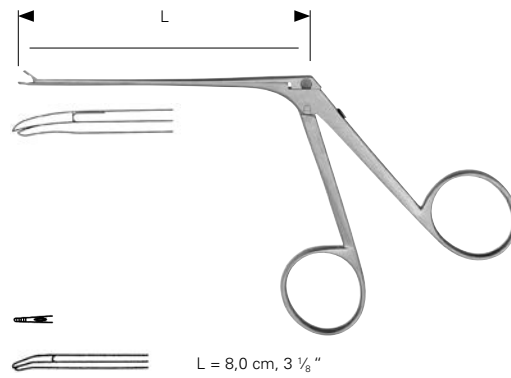

L = 8,0 cm, 3 1/8"

SCHUKNECHT

CH-420-02 0,8 x 6,0 mm
Curved downwards

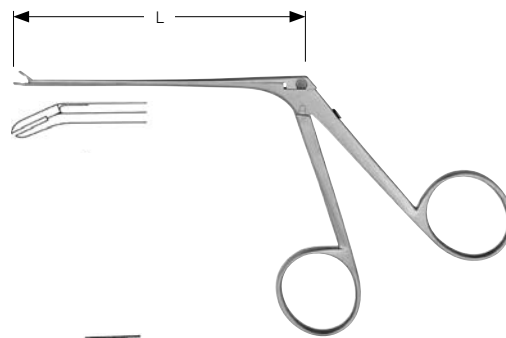

MC GEE



L = 8,0 cm, 3 1/8"

CH-422-01 0,8 x 3,5 mm
Curved downwards



L = 8,0 cm, 3 1/8"

CH-422-02 0,8 x 5,5 mm
Curved downwards



L = 8,0 cm, 3 1/8"

CH-422-03 0,8 x 3,5 mm
Right

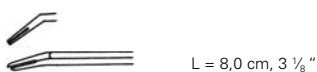

L = 8,0 cm, 3 1/8"

CH-422-04 0,8 x 3,5 mm
Left

Micro Ear Forceps

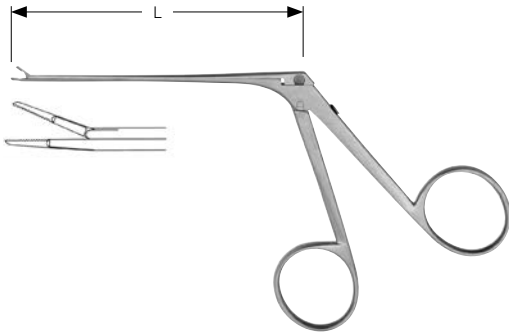

JUERS

CH-424-01 8,0 cm, 3 1/8"

Wire bending forceps, left

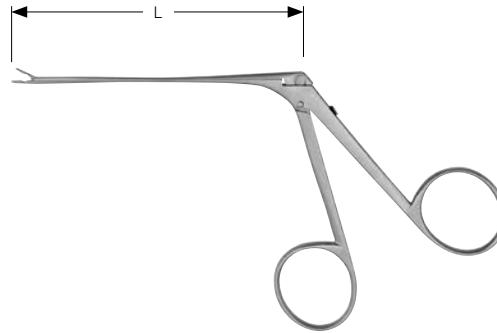

FULLER

CH-428-01 8,0 cm, 3 1/8"

Introducing forceps for teflon prothesis



JUERS

CH-424-02 8,0 cm, 3 1/8"

Wire bending forceps, right

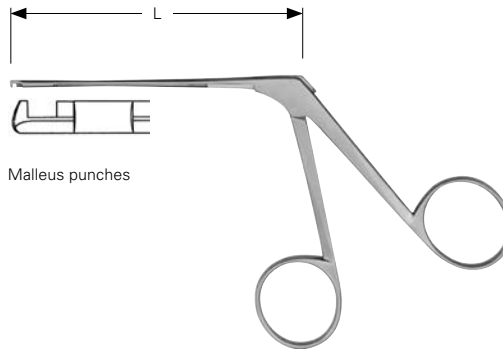

HOUSE-DIETER

CH-426-01 L = 8,0 cm, 3 1/8"

CH-426-01 1,3 mm

Down-cutting

CH-426-02 L = 8,0 cm, 3 1/8"

CH-426-02 1,3 mm

Up-cutting

CH-426-03 L = 8,0 cm, 3 1/8"

CH-426-03 1,3 mm

Left cutting

CH-426-04 L = 8,0 cm, 3 1/8"

CH-426-04 1,3 mm

Right cutting

Micro Ear Forceps, Micro Cup-Shaped Forceps

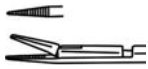
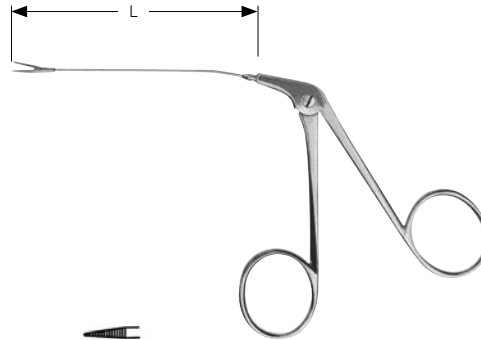

L = 8,0 cm, 3 1/8"

CH-450-01 3,5 x 0,8 mm
CH-450-02 5,0 x 1,0 mm

Straight With tubular shaft

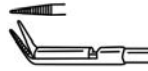

L = 8,0 cm, 3 1/8"

CH-450-04 3,5 x 0,8 mm
Curved upwards With tubular shaft



L = 8,0 cm, 3 1/8"

CH-450-05 3,5 x 0,8 mm
Curved downwards With tubular shaft

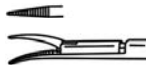

L = 8,0 cm, 3 1/8"

CH-450-06 5,0 x 1,0 mm
Left With tubular shaft

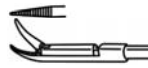

L = 8,0 cm, 3 1/8"

CH-450-07 5,0 x 1,0 mm
Left With tubular shaft

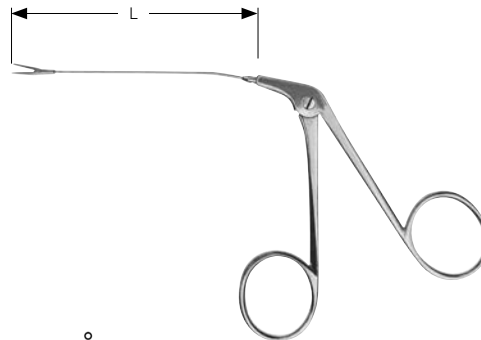

L = 8,0 cm, 3 1/8"

CH-452-01 0,9 x 1,0 mm
CH-452-02 0,8 x 1,3 mm
CH-452-04 1,7 x 2,5 mm

Straight, oval With tubular shaft



L = 8,0 cm, 3 1/8"

CH-452-03 Ø 1,0 mm
Straight, round With tubular shaft



L = 8,0 cm, 3 1/8"

CH-452-05 0,9 x 1,0 mm
Curved upwards, oval With tubular shaft



L = 8,0 cm, 3 1/8"

CH-452-06 0,8 x 1,3 mm
Left, oval With tubular shaft



L = 8,0 cm, 3 1/8"

CH-452-07 0,8 x 1,3 mm
Right, oval With tubular shaft

Handle for Endoscopes, Trocars for Sinus Surgery

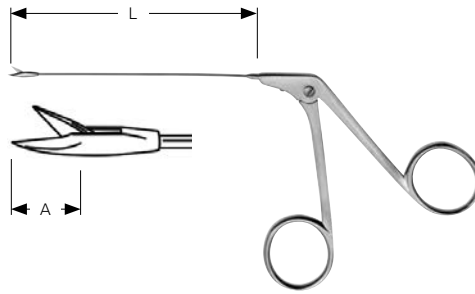

BELLUCCI



CH-454-01 A = 4,0 mm
Straight With tubular shaft



CH-454-02 A = 4,0 mm
Bent upwards With tubular shaft



CH-454-03 A = 4,0 mm
Curved left With tubular shaft



CH-454-04 A = 4,0 mm
Curved right With tubular shaft



CH-454-05 A = 4,0 mm
Horizontal cutting With tubular shaft

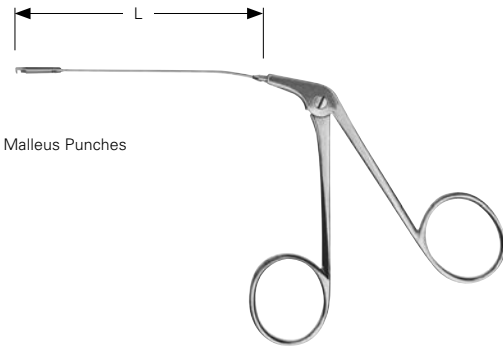

Malleus Punches



DIETER
CH-454-06 1,3 mm
Up-cutting With tubular shaft

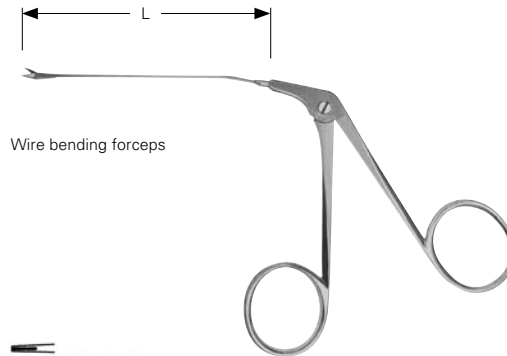

Wire bending forceps



MC GEE
CH-454-08 0,8 x 3,5 mm
Curved downwards With tubular shaft



DIETER
CH-454-07 1,3 mm
Down-cutting With tubular shaft



MC GEE
CH-454-09 0,8 x 5,5 mm
Curved downwards With tubular shaft

Ear Forceps

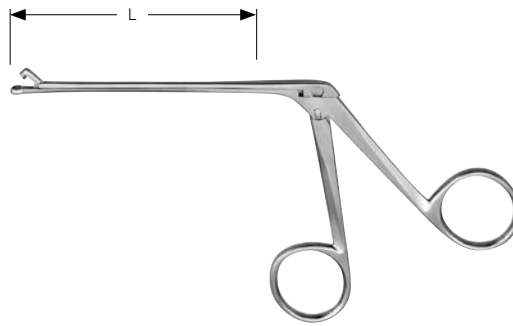

HARTMANN

CH-209-14 8,5 cm, 3 1/3"

Grasping forceps, duckbill jaw



HARTMANN-WULLSTEIN

CH-210-07 8,5 cm, 3 1/3"

Grasping forceps



HARTMANN-WULLSTEIN

CH-210-08 8,5 cm, 3 1/3"

Grasping forceps

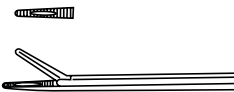

HARTMANN

CH-214-08 8,5 cm, 3 1/3"

CH-214-14 14,0 cm, 5 1/2"

CH-214-16 16,5 cm, 6 1/2"

Grasping forceps



HARTMANN

CH-215-01 15,0 cm, 6"

Grasping forceps, delicate, serrated



HARTMANN

CH-215-02 15,0 cm, 6"

Grasping forceps, rough, serrated

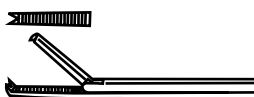

HARTMANN

CH-216-08 8,5 cm, 3 1/3"

CH-216-14 14,0 cm, 5 1/2"

Grasping forceps, 1 x 2 teeth

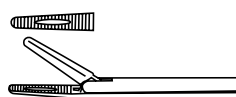

HARTMANN-NOYES

CH-218-09 8,5 cm, 3 1/3"

Grasping forceps

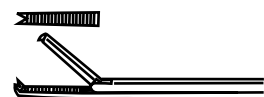

HARTMANN-NOYES

CH-220-09 8,5 cm, 3 1/3"

Grasping forceps, 1 x 2 teeth

Ear Forceps

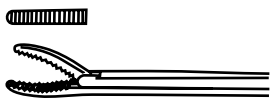
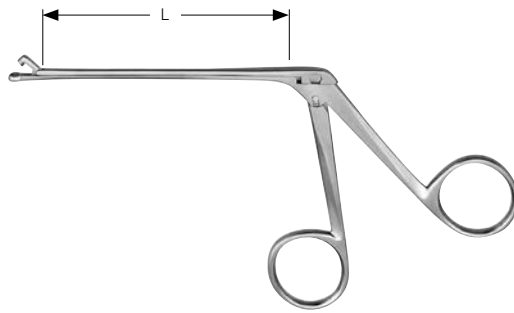

HARTMANN-WEINGAERTNER

CH-222-08 8,5 cm, 3 1/3"

Grasping forceps



2,0 x 7,0 mm

HARTMANN

CH-224-08 8,5 cm, 3 1/3"

Spoon forceps, oval



2,0 x 7,0 mm

HARTMANN

CH-224-18 18,0 cm, 7"

Spoon forceps, oval



2,0 x 7,0 mm

HARTMANN

CH-224-18 B 18,0 cm, 7"

Spoon forceps, oval, ceramic coating

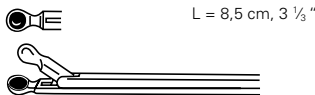

L = 8,5 cm, 3 1/3"

HARTMANN

CH-226-01 Ø 2,0 mm

CH-226-02 Ø 2,5 mm

CH-226-03 Ø 3,0 mm

Spoon forceps



L = 15,0 cm, 6"

HARTMANN

CH-226-11 Ø 2,0 mm

Spoon forceps



L = 12,5 cm, 5"

HARTMANN

CH-226-12 Ø 2,5 mm

Spoon forceps



L = 8,5 cm, 3 1/3"

HARTMANN-HOFFMANN

CH-226-20 Ø 2,0 mm

Spoon forceps, through cutting

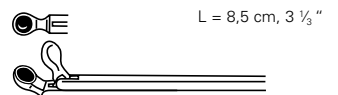

L = 8,5 cm, 3 1/3"

HARTMANN

CH-228-07 Ø 2,0 mm

CH-228-08 Ø 3,0 mm

Spoon forceps, 45°

Ear Forceps

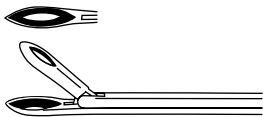
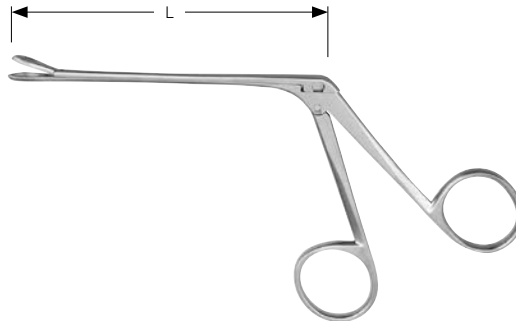

STRUEMPEL

CH-230-08 8,5 cm, 3 1/3"

CH-230-18 12,5 cm, 5"

Spoon forceps, oval



STRUEMPEL

CH-230-19 12,5 cm, 5"

Spoon forceps, oval, 45°



STRUEMPEL

CH-230-20 12,5 cm, 5"

Spoon forceps, oval, 90°

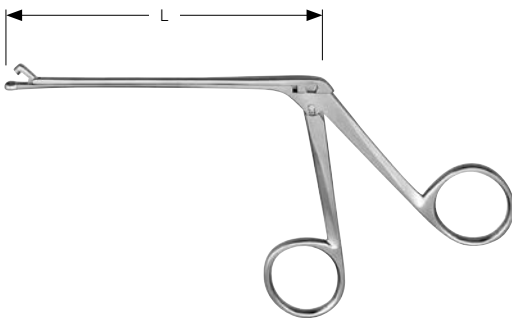

CH-231-12 12,5 cm, 5"

Grasping forceps, 45°



MASING

CH-234-15 8,5 cm, 3 1/3"

Needle holder



Sinus Surgery



Table of Content | Chapter

















| Product group | Page |
|---|----------------|
|  <p>Sinuscopes and Accessories</p> | 100-104 |
|  <p>Flexible Naso-Pharyngo-Laryngoscope, Suction and Irrigation Instruments Suction Tubes</p> | 105-107 |
|  <p>Suction Tubes, Bipolar Forceps with Irrigation</p> | 108 |
|  <p>Bipolar Forceps with Douth Irrigation and Luer-Lock Connector</p> | 109-115 |
|  <p>Special Needles</p> | 116 |
|  <p>Septum Elevators</p> | 117-118 |
|  <p>Suction Raspatories, Frontal Sinus Bougies</p> | 119 |
|  <p>Antrum Rasps, Probe</p> | 120 |

Table of Content | Chapter



| Product group | Page |
|---|----------------|
|  <p>Chisels, Gougas, Raspatories, Antrum Curettes,</p> | 120-123 |
|  <p>Nasal Scissors, SUPERCUT Scissors</p> | 124-126 |
|  <p>Rongeurs</p> | 127-128 |
|  <p>Frontal Sinus Punches, Circular Cutting Punches, Antrum Punches, Antrum Grasping Forceps, Septum Forceps</p> | 129-137 |
|  <p>Nasal Forceps, Nasal Speculas, Nasal Scissors, Antrum Punches, Rongeurs</p> | 138-154 |
|  <p>Retractors</p> | 153 |
|  <p>Spatula, Lip Retractors</p> | 154 |

Sinusscopes

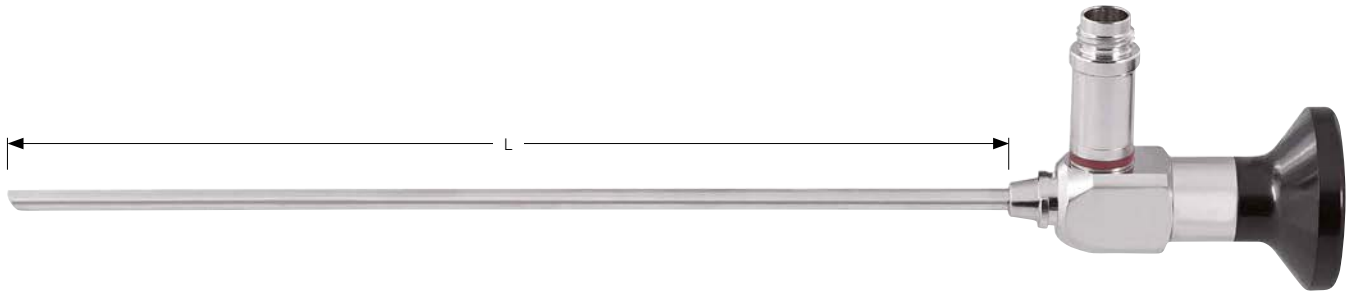

| Length | Ø | Angle | | | |
|----------|--------|---|---|---|--|
| | | 0° | 30° | 45° | 70° |
| 110,0 mm | 2,7 mm | CH-100-00 ■ | CH-100-30 ■ | | CH-100-70 ■ |
| 140,0 mm | 2,7 mm | CH-101-00 ■ | CH-101-30 ■ | | |
| 175,0 mm | 2,7 mm | CH-102-00 ■ | CH-102-30 ■ | | CH-102-70 ■ |
| 187,5 mm | 2,7 mm | CH-103-00 ■ | CH-103-30 ■ | | CH-103-70 ■ |
| 175,0 mm | 4,0 mm | CH-104-00 ■ | CH-104-30 ■ | CH-104-45 ■ | CH-104-70 ■ |

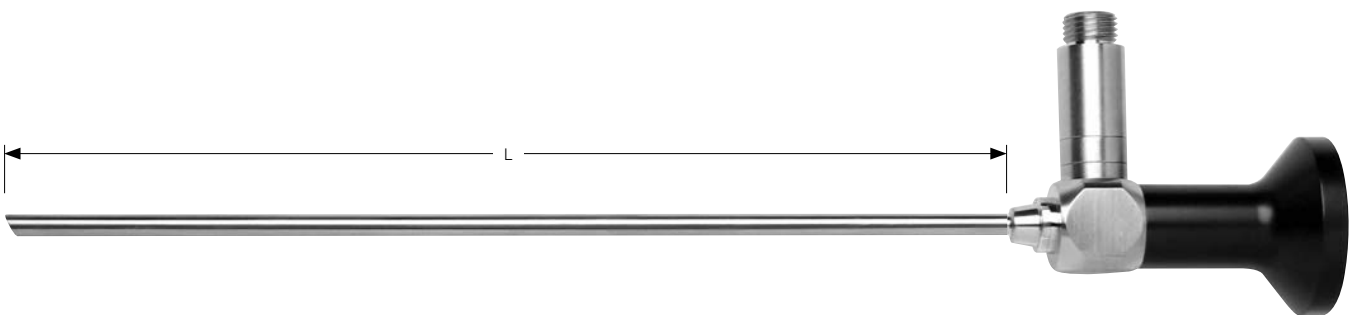

| Length | Ø | Angle | | | |
|----------|--------|----------------------|----------------------|----------------------|----------------------|
| | | 0° | 30° | 45° | 70° |
| 175,0 mm | 4,0 mm | CH-104-00 UHD | CH-104-30 UHD | CH-104-45 UHD | CH-104-70 UHD |

3-Shaft Endoscope

Handle for Endoscopes, Trocars for Sinus Surgery

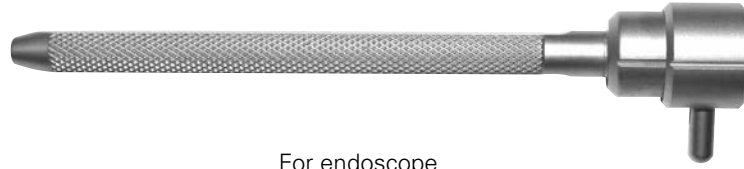

For endoscope

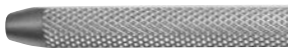

| | | |
|---------|------------------|------------------|
| Version | Ø 2,7 mm | Ø 4,0 mm |
| Round | CH-950-27 | CH-950-40 |
| Flat | CH-952-27 | CH-952-40 |

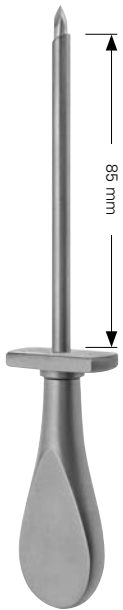

| | |
|------------------|----------------|
| | 30° |
| CH-792-02 | Ø 4,0 5,0 mm |
| CH-792-03 | Ø 3,0 4,0 mm |
| CH-792-04 | Ø 2,7 3,3 mm |

CH-792-02 - CH-792-04 16,0 cm, 6 ¼"



Endoscopic Biopsy- & Grasping Forceps



Flexible

CH-640-00

for Endoscopes 0°, Ø 2.7 mm, **WL. 175.0 mm**

CH-641-00

for Endoscopes 0°, Ø 2.7 mm, **WL. 187.5 mm**

Rigid

CH-642-00

for Endoscopes 0°, Ø 2.7 mm, **WL. 187.5 mm**



Endoscopic Biopsy- & Grasping Forceps



Rigid

CH-642-70

for Endoscopes 70°, Ø 2.7 mm, **WL. 1875 mm**

CH-644-70

for Endoscopes 70°, Ø 4.0 mm, **WL. 175.0 mm**

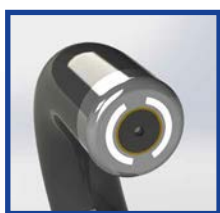

Flexible Naso-Pharyngo-/ Laryngofibrescopes

Accessoires:
- Leakage tester
- ETO-Cap

CH-149-00 Ø 2,2 mm

One hand control, 2-side angulation, length of angulated tip 20 mm

| Length | Fibre bundle | Angulation up down | Direction of view | Field of view | Depth of field |
|--------|--------------|----------------------|-------------------|---------------|----------------|
| 300 mm | 6.500 Pixel | 160° 160° | 0° | 88° | 3 - 50 mm |

CH-150-00 Ø 2,8 mm

One hand control, 2-side angulation, length of angulated tip 20 mm

| Length | Fibre bundle | Angulation up down | Direction of view | Field of view | Depth of field |
|--------|--------------|----------------------|-------------------|---------------|----------------|
| 300 mm | 16.000 Pixel | 160° 160° | 0° | 85° | 1 - 50 mm |

CH-152-00 Ø 3,2 mm

One hand control, 2-side angulation, length of angulated tip 20 mm

| Length | Fibre bundle | Angulation up down | Direction of view | Field of view | Depth of field |
|--------|--------------|----------------------|-------------------|---------------|----------------|
| 300 mm | 16.000 Pixel | 160° 160° | 0° | 85° | 1 - 50 mm |

CH-154-00 Ø 3,4 mm

One hand control, 2-side angulation, length of angulated tip 25 mm

| Length | Fibre bundle | Angulation up down | Direction of view | Field of view | Depth of field |
|--------|--------------|----------------------|-------------------|---------------|----------------|
| 300 mm | 16.000 Pixel | 160° 160° | 0° | 85° | 1 - 50 mm |

**Flexible Naso-Pharyngo-/ Laryngofibrescope
with Instrument Channel**



Accessoires:
- Leakage tester
- ETO-Cap

CH-156-00 Ø 3,8 mm

One hand control, 2-side angulation, length of angulated tip 20 mm, **instrument channel Ø 1.4 mm**

| Length | Fibre bundle | Angulation up down | Direction of view | Field of view | Depth of field |
|--------|--------------|----------------------|-------------------|---------------|----------------|
| 300 mm | 14.000 Pixel | 160° 160° | 0° | 85° | 3 - 50 mm |



Suction and Irrigation Instruments



Antrum trocar

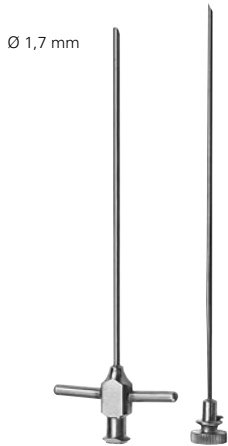

LICHTWITZ

CH-955-00 11,0 cm, 4 3/8"

Antrum trocar needles

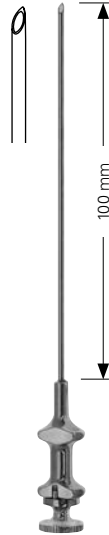

LICHTWITZ

CH-955-15 Ø 1,5 mm

CH-955-18 Ø 1,8 mm

CH-955-20 Ø 2,0 mm

Antrum irrigation cannulas



EICKEN

CH-957-25 Ø 2,5 mm

CH-957-30 Ø 3,0 mm

CH-957-40 Ø 4,0 mm

Antrum irrigation cannulas



EICKEN

CH-957-26 Ø 2,5 mm

CH-957-31 Ø 3,0 mm

CH-957-41 Ø 4,0 mm

Antrum irrigation cannulas



EICKEN

CH-958-25 Ø 2,5 mm

CH-958-30 Ø 3,0 mm

CH-958-40 Ø 4,0 mm

Antrum irrigation cannulas

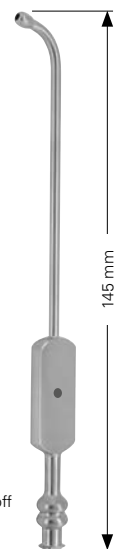

EICKEN

CH-958-26 Ø 2,5 mm

CH-958-31 Ø 3,0 mm

CH-958-41 Ø 4,0 mm

Suction Tubes

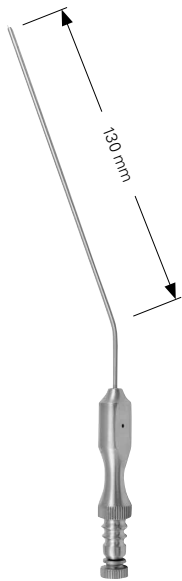

FRAZIER

| | |
|------------------|-----------|
| CH-902-06 | 6 Charr. |
| CH-902-07 | 7 Charr. |
| CH-902-08 | 8 Charr. |
| CH-902-09 | 9 Charr. |
| CH-902-10 | 10 Charr. |
| CH-902-11 | 11 Charr. |
| CH-902-12 | 12 Charr. |
| CH-902-15 | 15 Charr. |

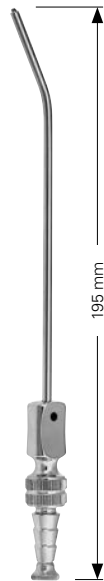

PLESTER

| | |
|------------------|-----------|
| CH-903-05 | 5 Charr. |
| CH-903-07 | 7 Charr. |
| CH-903-08 | 8 Charr. |
| CH-903-09 | 9 Charr. |
| CH-903-10 | 10 Charr. |

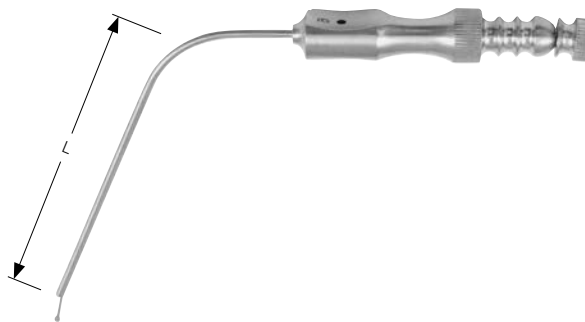

FERGUSSON

| Ø | Length 110 mm | Length 130 mm | Length 160 mm | Length 200 mm |
|-----------|------------------|------------------|------------------|------------------|
| 4 Charr. | CH-904-04 | | | |
| 5 Charr. | CH-904-05 | CH-904-25 | CH-904-45 | CH-904-65 |
| 6 Charr. | CH-904-06 | CH-904-26 | CH-904-46 | CH-904-66 |
| 7 Charr. | CH-904-07 | | | |
| 8 Charr. | CH-904-08 | CH-904-28 | CH-904-48 | CH-904-68 |
| 9 Charr. | CH-904-09 | CH-904-29 | CH-904-49 | CH-904-69 |
| 10 Charr. | CH-904-10 | | | |
| 11 Charr. | CH-904-11 | | | |
| 12 Charr. | CH-904-12 | CH-904-32 | CH-904-52 | CH-904-72 |
| 15 Charr. | CH-904-15 | CH-904-35 | CH-904-55 | CH-904-75 |

Suction Bipolar Forceps with Irrigation



Straight

Width of tips

Length

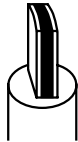

| | | |
|------------|--------|--------------------|
| 0,5 x 8 mm | 180 mm | CH-700-18 I |
| | 200 mm | CH-700-20 I |

| | | |
|------------|--------|--------------------|
| 1,0 x 8 mm | 180 mm | CH-710-18 I |
| | 200 mm | CH-710-20 I |

| | | |
|------------|--------|--------------------|
| 2,0 x 8 mm | 180 mm | CH-712-18 I |
| | 200 mm | CH-712-20 I |



Bayonet

Anchura de puntas

Length

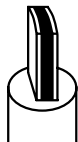

| | | |
|------------|--------|--------------------|
| 0,5 x 5 mm | 180 mm | CH-740-18 I |
| | 200 mm | CH-740-20 I |
| | 220 mm | CH-740-22 I |

| | | |
|------------|--------|--------------------|
| 1,0 x 5 mm | 180 mm | CH-750-18 I |
| | 200 mm | CH-750-20 I |
| | 220 mm | CH-750-22 I |

| | | |
|------------|--------|--------------------|
| 2,0 x 5 mm | 180 mm | CH-752-18 I |
| | 200 mm | CH-752-20 I |
| | 220 mm | CH-752-22 I |

Bipolar Forceps with Double Irrigation and Luer-lock Connector



Width of tips

Length

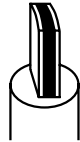

| | | |
|------------|--------|--------------------|
| 1,0 x 8 mm | 220 mm | CH-751-22 I |
| 1,5 x 8 mm | 220 mm | CH-753-22 I |



Order quantity: 40 pieces

CH-751-90



Tubing set, sterile, single use



Bipolar Forceps





Bipolar Forceps, straight, flat-plug, 500 Vp

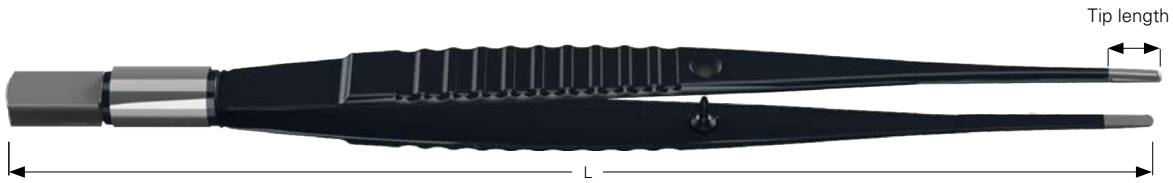

Order quantity: 1 piece





| Version | Tip | L = 165 mm | L = 180 mm | L = 195 mm | L = 225 mm |
|---|--------------|------------------|------------------|------------------|------------------|
|  Bipolar forceps, Needle | 6 mm 8 mm | CH-700-16 | CH-700-18 | CH-700-20 | CH-700-22 |
|  Bipolar forceps, Blunt, 1.0 mm | 6 mm 8 mm | CH-710-16 | CH-710-18 | CH-710-20 | CH-710-22 |
|  Bipolar forceps, Blunt, 2.0 mm | 6 mm 8 mm | CH-712-16 | CH-712-18 | CH-712-20 | CH-712-22 |

Bipolar Forceps, angled, flat-plug, 500 Vp



Order quantity: 1 piece



| Version | Tip | L = 165 mm | L = 180 mm | L = 190 mm | L = 225 mm |
|--|--------------|------------------|------------------|------------------|------------------|
|  Bipolar forceps, Needle | 6 mm 8 mm | CH-720-16 | CH-720-18 | CH-720-20 | CH-720-22 |
|  Bipolar forceps, Blunt, 1.0 mm | 6 mm 8 mm | CH-730-16 | CH-730-18 | CH-730-20 | CH-730-22 |
|  Bipolar forceps, Blunt, 2.0 mm | 6 mm 8 mm | | CH-732-18 | CH-732-20 | CH-732-22 |

! All bipolar forceps also with NON-STICK tip available

NON-STICK Silver tip

Bipolar Forceps





Bipolar Forceps, bayonet, flat-plug, 500 Vp



Order quantity:
1 piece



| Version | Tip | L = 165 mm | L = 180 mm | L = 195 mm | L = 220 mm | L = 240 mm |
|---|--------------|------------------|------------------|------------------|------------------|------------------|
|  Bipolar forceps, Needle | 6 mm 8 mm | CH-740-16 | CH-740-18 | CH-740-20 | CH-740-22 | |
|  Bipolar forceps, Blunt, 1.0 mm | 6 mm 8 mm | CH-750-16 | CH-750-18 | CH-750-20 | CH-750-22 | CH-750-24 |
|  Bipolar forceps, Blunt, 2.0 mm | 6 mm 8 mm | CH-752-16 | CH-752-18 | CH-752-20 | CH-752-22 | CH-752-24 |





Plug instrument side

Bipolar connecting cables



Flat plug, square

Flat plug, round

| | Plug unit side | Length | Item number | |
|---|------------------------------------|--------|------------------|------------------|
|  | VALLEYLAB USA / 2 banana | 3,0 m | CH-217-30 | CH-247-30 |
| | | 5,0 m | CH-217-50 | CH-247-50 |
| 28,2 mm  | AMNOTOM BOWA VALLEYLAB EUROPE | 3,0 m | CH-215-30 | CH-245-30 |
| | | 5,0 m | CH-215-50 | CH-245-50 |
| Ø 7,8 mm  | MARTIN I BERCHTOLD | 3,0 m | CH-213-30 | CH-243-30 |
| | | 5,0 m | CH-213-50 | CH-243-50 |
| Ø 12,3 mm  | ERBE STORZ WISAP | 3,0 m | CH-211-30 | CH-241-30 |
| | | 5,0 m | CH-211-50 | CH-241-50 |

Bipolar Micro-Coagulation Forceps

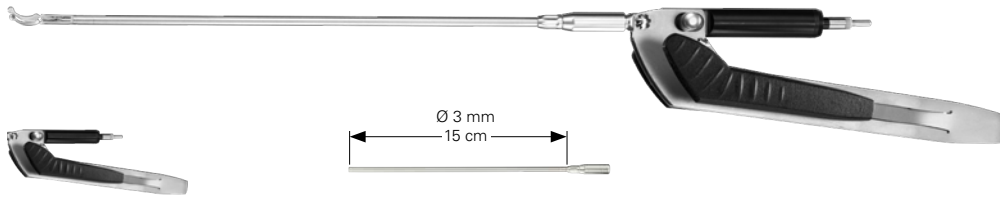

CH-100-00
Handle, bayonet

CH-100-02
Shaft, bayonet

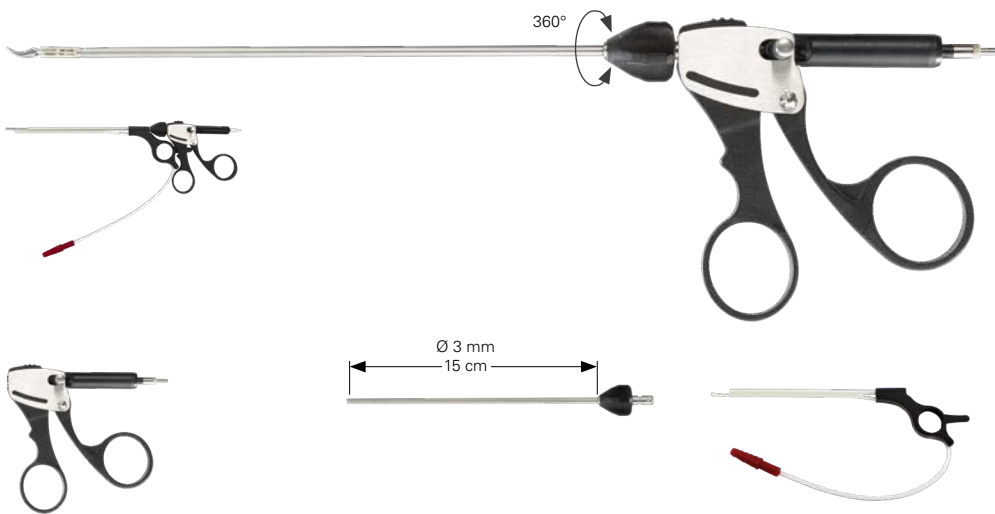

CH-100-10
Ring handle







CH-100-12
Shaft, Ring handle



CH-100-90
Suction probe

| | Plug unit side | Length | Round plug |
|-----------|----------------|--------|------------------|
| 28,2 mm | | 3,0 m | CH-205-30 |
| | | 5,0 m | CH-205-50 |
| Ø 7,8 mm | | 3,0 m | CH-201-30 |
| | | 5,0 m | CH-201-50 |
| Ø 12,3 mm | | 3,0 m | CH-201-30 |
| | | 5,0 m | CH-201-50 |

Electrodes for Bipolar Micro-Coagulation Forceps

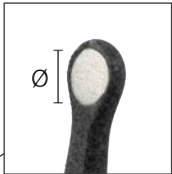

| | | Insert, only | Complete, bayonet handle | Complete, ring handle |
|---|--------------------------------|------------------|--------------------------|-----------------------|
|  | Scissors, curved | CH-120-03 | CH-120-03 C | CH-120-03 CS |
|  | Grasping forceps, fenestrated | CH-102-03 | CH-102-03 C | CH-102-03 CS |
|  | Spoon forceps Ø 2 mm, curved | CH-104-03 | CH-104-03 C | CH-104-03 CS |
|  | Spoon forceps Ø 2.7 mm, curved | CH-106-03 | CH-106-03 C | CH-106-03 CS |
|  | Dissector Maryland, curved | CH-108-03 | CH-108-03 C | CH-108-03 CS |
|  | Dissector, angled | CH-110-03 | CH-110-03 C | CH-110-03 CS |

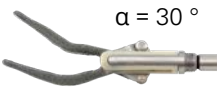
| | | | Insert, only | Complete, bayonet handle | Complete, ring handle |
|---|------------------------|----------------------------------|--|---|---|
|  | | | |  |  |
|  | | | | | |
|  | Flamingo jaw, vertical | Ø 0,7 mm Ø 1,2 mm Ø 2,0 mm | CH-112-07 CH-112-12 CH-112-20 | CH-112-07 C CH-112-12 C CH-112-20 C | CH-112-07 CS CH-112-12 CS CH-112-20 CS |
|  | Flamingo jaw, vertical | Ø 0,7 mm Ø 1,2 mm Ø 2,0 mm | CH-114-07 CH-114-12 CH-114-20 | CH-114-07 C CH-114-12 C CH-114-20 C | CH-114-07 CS CH-114-12 CS CH-114-20 CS |
|  | Flamingo jaw, vertical | Ø 0,7 mm Ø 1,2 mm Ø 2,0 mm | CH-116-07 CH-116-12 CH-116-20 | CH-116-07 C CH-116-12 C CH-116-20 C | CH-116-07 CS CH-116-12 CS CH-116-20 CS |

Bipolar Stitch Coagulation Electrodes

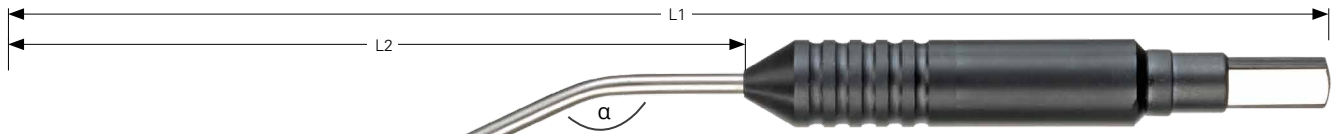

Angle α Length 1 Length 2 Item number

20 ° 190 mm 105 mm **CH-670-00**

30 ° 195 mm 110 mm **CH-670-02**

55 ° 195 mm 112 mm **CH-670-04**

60 ° 175 mm 90 mm **CH-670-06**

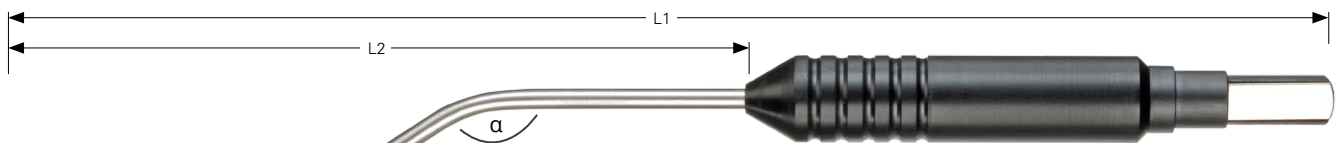

Angle α Length 1 Length 2 Item number

30 ° 190 mm 105 mm **CH-670-10**

Bipolar Probe Electrodes

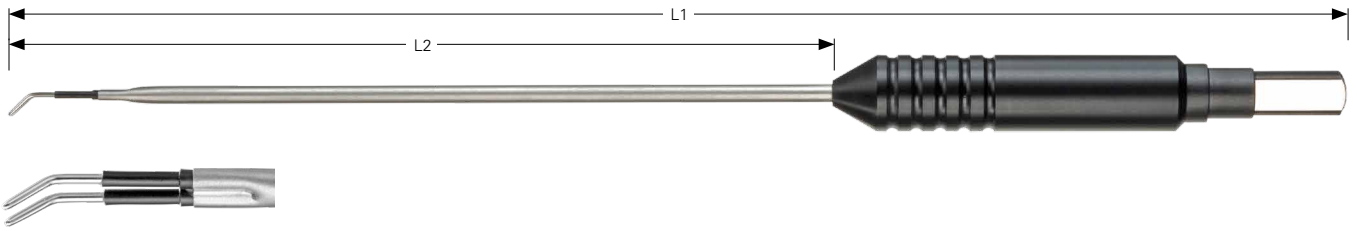

Tip 45° curved

Angle α Length 1 Length 2 Item number



0° 215 mm 130 mm **CH-670-30**

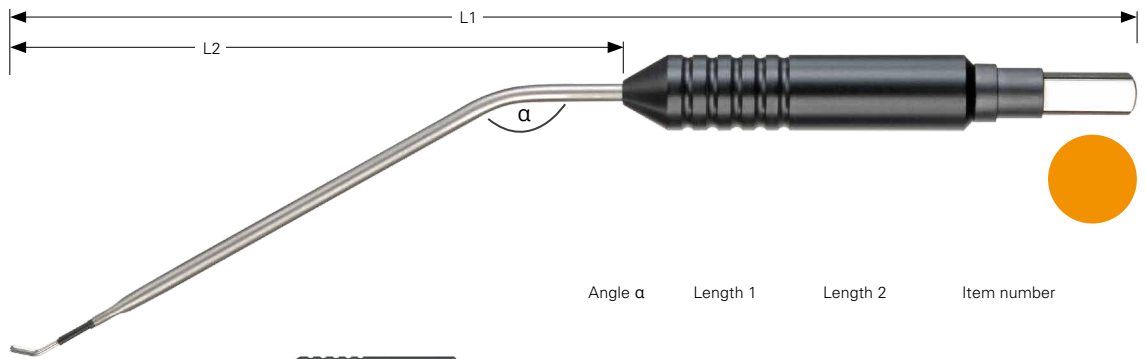

Angle α Length 1 Length 2 Item number



30° 185 mm 100 mm **CH-670-32**



45° 185 mm 100 mm **CH-670-34**



90° 185 mm 100 mm **CH-670-36**

Special Needles

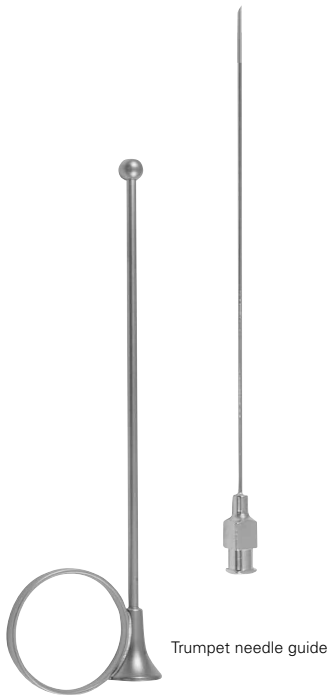

Trumpet needle guide

IOWA

CH-802-00 14,0 cm, 5 ¼"



Tonsil needle

CH-810-01 Ø 0,8 x 100 mm



Tonsil needle

CH-810-02 Ø 0,8 x 80 mm



Septum needle

CH-810-03 Ø 0,8 x 107 mm

Septum Elevators



3,3 mm
CH-655-18

HALLE
CH-655-18 18,0 cm, 7"



Ø 4,0 mm
CH-660-21

Suction elevator

FREER-GORNEY
CH-660-21 21,0 cm, 8 ¼"

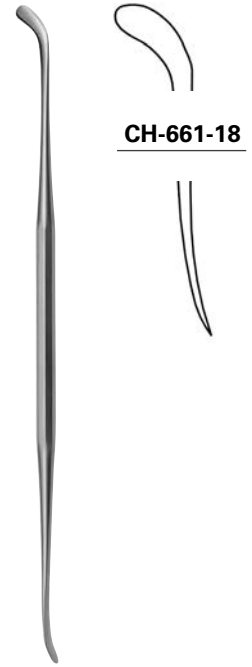

CH-661-18

FREER
CH-661-18 17,5 cm, 7"

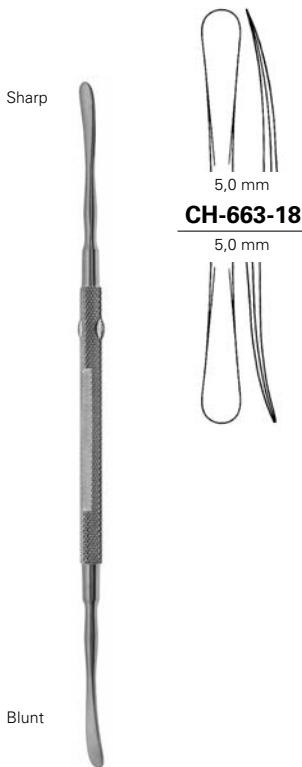

5,0 mm
CH-663-18
5,0 mm

FREER
CH-663-18 18,0 cm, 7"

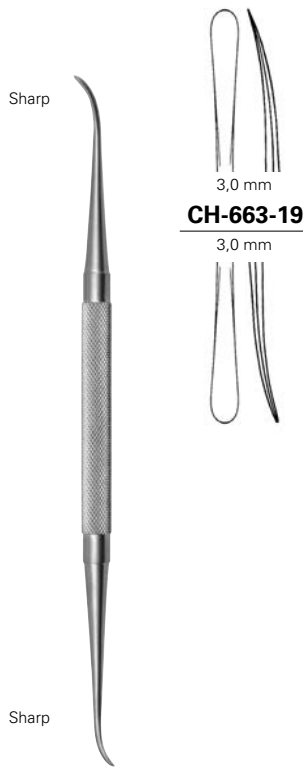

3,0 mm
CH-663-19
3,0 mm

FREER-YASARGIL
CH-663-19 18,5 cm, 7 ¼"

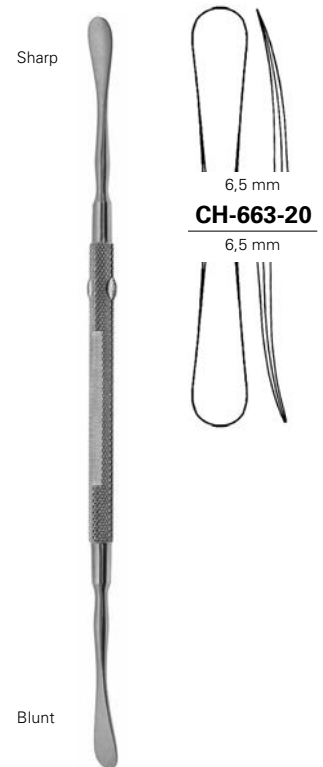

6,5 mm
CH-663-20
6,5 mm

FREER
CH-663-20 20,0 cm, 8"

Septum Elevators



FREER-JOSEPH

CH-663-21 20,0 cm, 8 "



FREER

CH-665-20 20,0 cm, 8 "

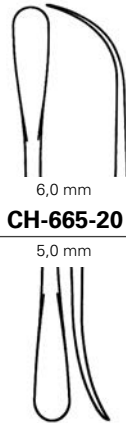

FREER

CH-668-19 19,0 cm, 7 1/2 "



CH-668-19



FREER

CH-669-01 19,0 cm, 7 1/2 "



CH-669-01



FREER

CH-669-02 19,0 cm, 7 1/2 "



CH-669-02



FREER

CH-669-03 19,0 cm, 7 1/2 "



CH-669-03

Suction Raspatories, Frontal Sinus Bougies



Ø 3,5 mm

Ø 3,5 mm

Ø 4,0 mm

Ø 4,0 mm

Ø 5,0 mm

Suction raspatory

Suction raspatory

Suction raspatory

Suction raspatory

GULEN

CH-697-14 14,5 cm, 5 ¾"

GULEN

CH-698-14 14,5 cm, 5 ¾"

CH-699-20 20,0 cm, 8"

CH-700-20 20,0 cm, 8"

CH-700-21 20,0 cm, 8"

Frontal sinus bougies

| | |
|------------------|----------|
| CH-561-02 | Ø 2,0 mm |
| CH-561-03 | Ø 3,0 mm |
| CH-561-04 | Ø 4,0 mm |
| CH-561-05 | Ø 5,0 mm |

RITTER

CH-561-02 - CH-561-05 16,0 cm, 6 ¼"

Antrum Rasps, Probe



CH-795-01

With trocar tip

WIENER

CH-795-01 18,0 cm, 7 "



CH-795-02

Blunt

WIENER

CH-795-02 18,0 cm, 7 "

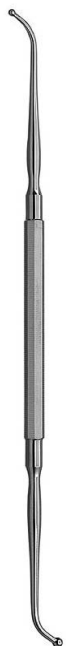

Probe, double-ended, maxillary sinus ostium seeker, ball-shaped ends

CH-658-18 18,0 cm, 7 "

Chisels, Gouges, Raspatories, Antrum Curettes

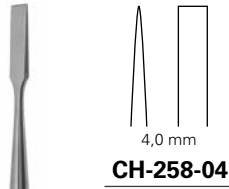

Chisel

WEST
CH-258-04 16,0 cm, 6 ¼"

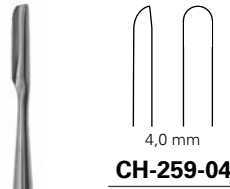

Gouge

WEST
CH-259-04 16,0 cm, 6 ¼"



Raspatory

SEWALL
CH-349-20 20,0 cm, 8"

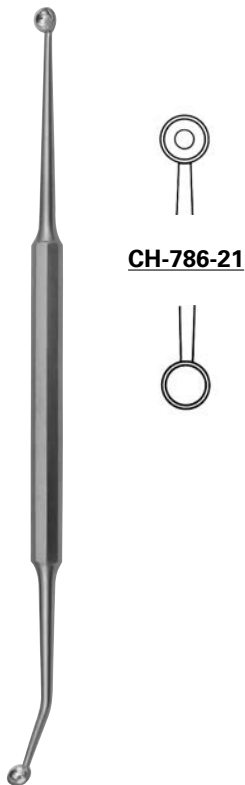

PRATT
CH-786-21 21,0 cm, 8 ¼"

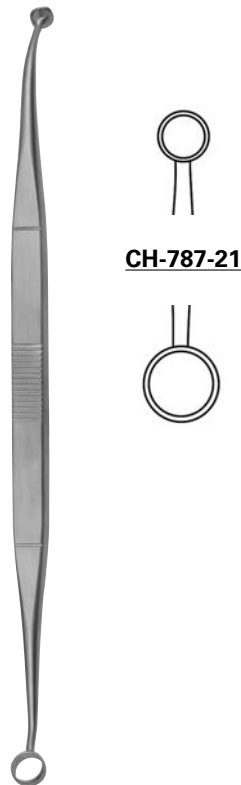

FAULKNER
CH-787-21 21,0 cm, 8 ¼"

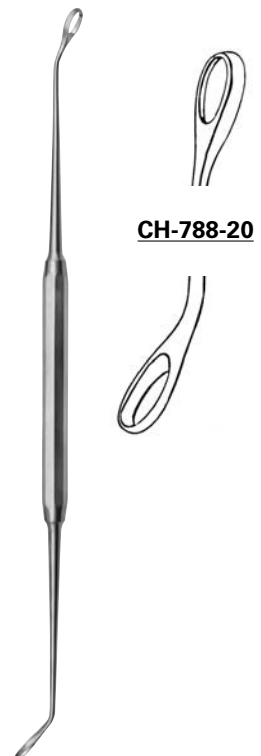

COAKLEY
CH-788-20 20,0 cm, 8"

Antrum Curettes, Antrum Scoops

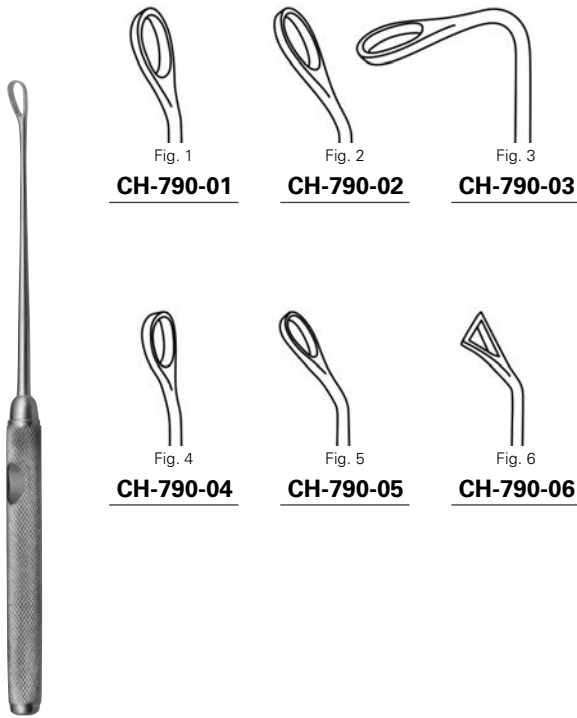

COAKLEY

CH-790-01 - CH-790-06 17,0 cm, 6 3/4"

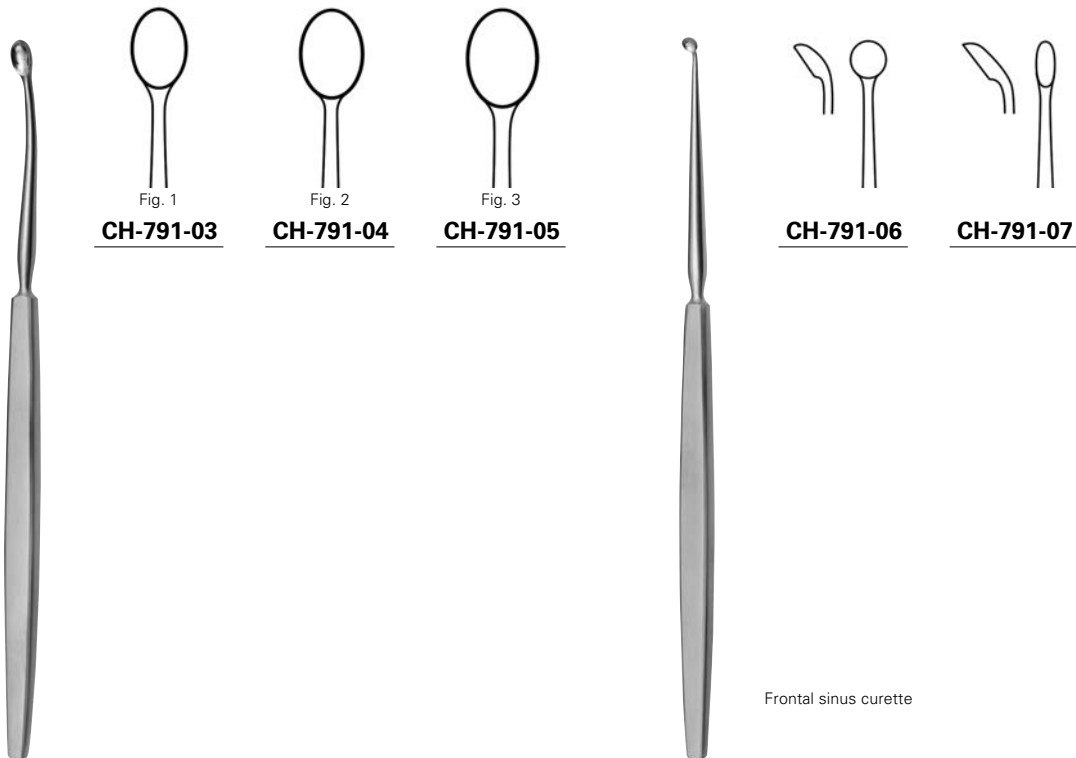

Frontal sinus curette

CH-791-03 - CH-791-05 19,0 cm, 7 1/2"

CH-791-06 - CH-791-07 19,0 cm, 7 1/2"

Antrum Curettes, Antrum Scoops, Sickle Knives

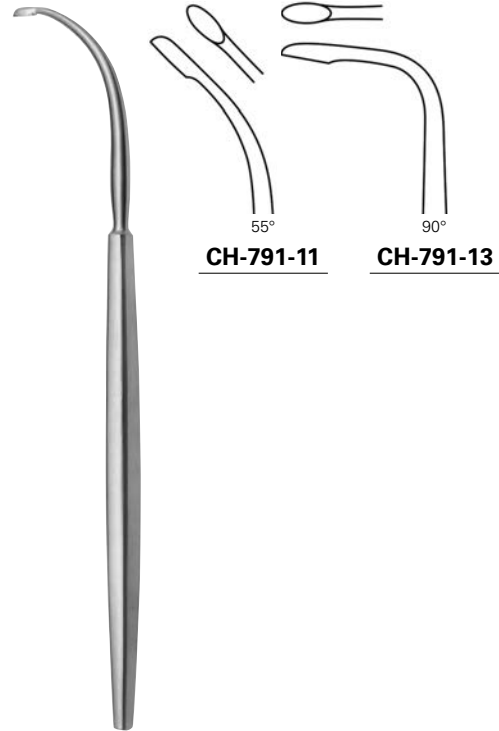
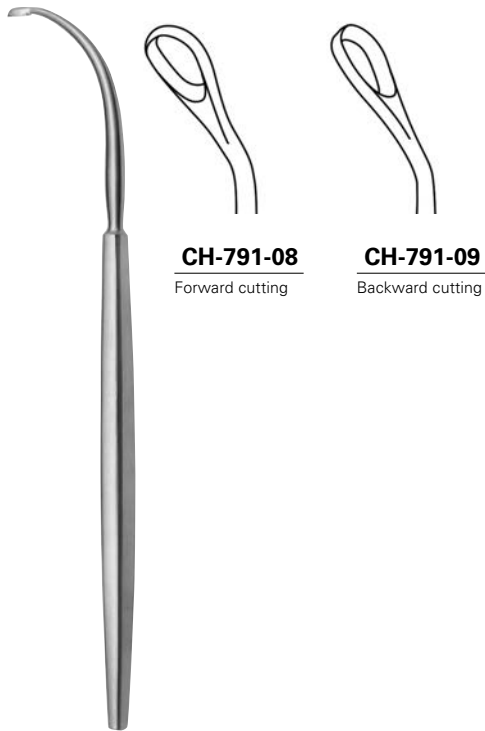

COAKLEY

CH-791-08 - CH-791-09 19,0 cm, 7 ½"

CH-791-11 - CH-791-13 19,0 cm, 7 ½"

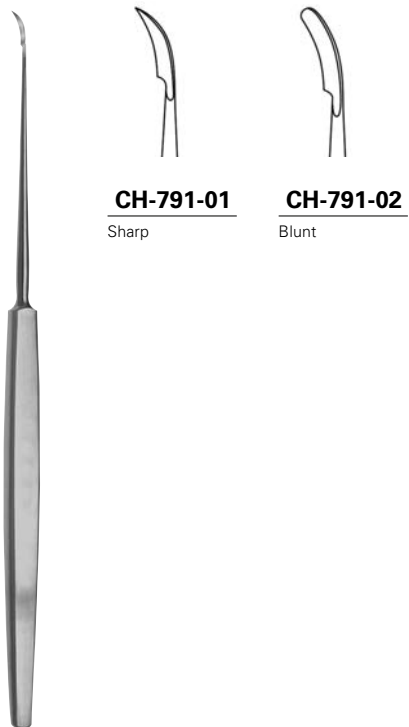

CH-791-01 - CH-791-02 19,0 cm, 7 ½"

Nasal Scissors

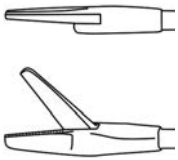
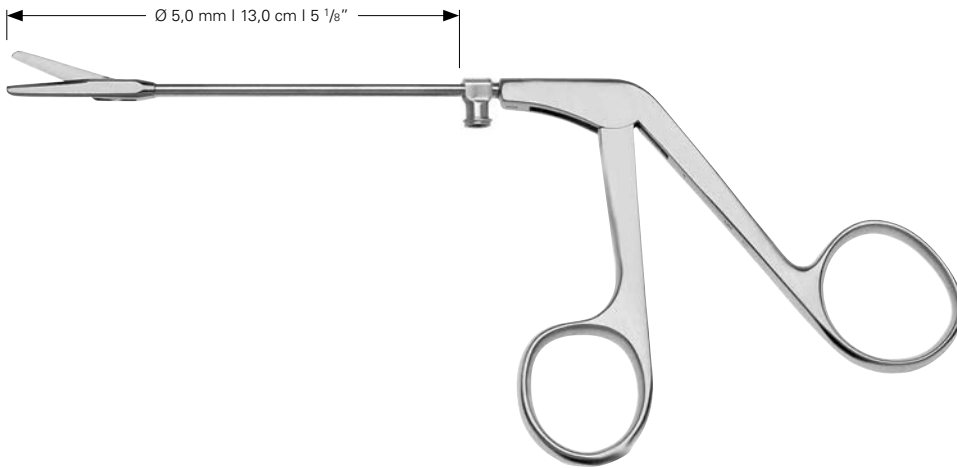

CH-600-00 LL

Straight

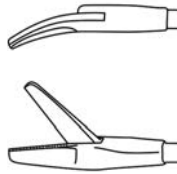

CH-600-01 LL

Curved left

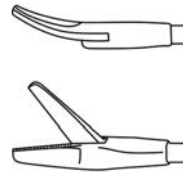

CH-600-02 LL

Curved right

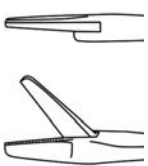
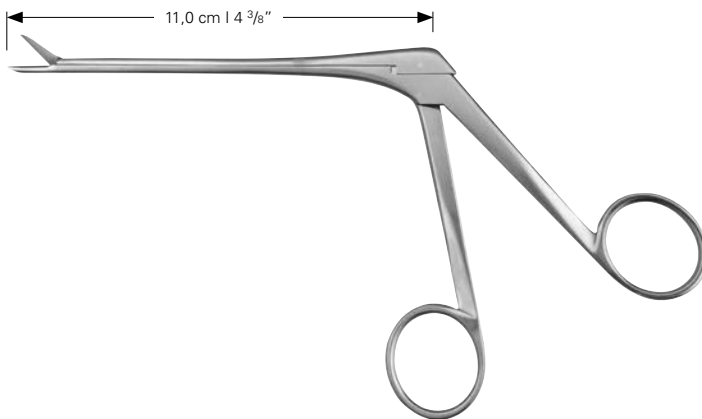

CH-600-10

Straight



CH-600-11

Curved left

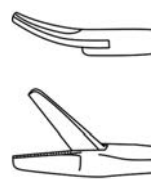

CH-600-12

Curved right

Nasal Scissors

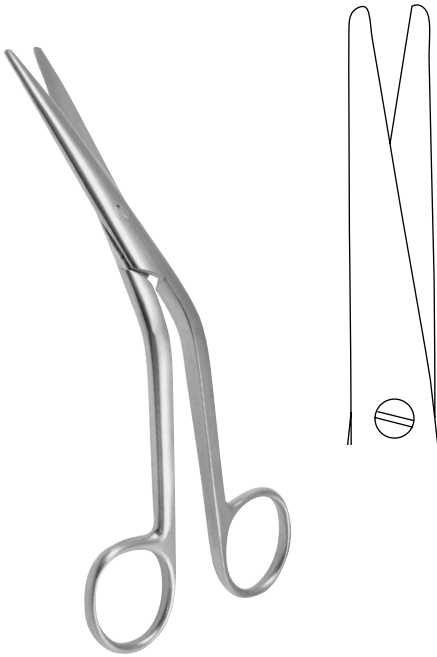

COTTLE

CH-331-16 16,0 cm, 6 ¼"

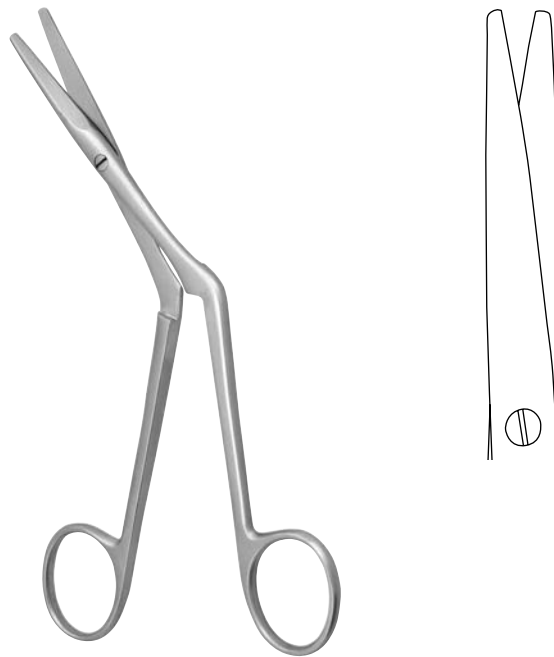

HEYMANN

CH-333-17 17,0 cm, 6 ¾"

CH-335-18 18,0 cm, 7"

CH-333-20 20,0 cm, 8"

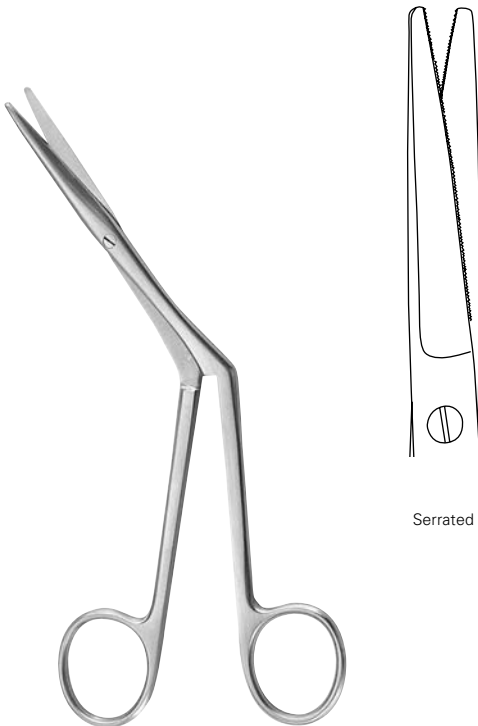

Serrated

HEYMANN

CH-337-18 18,0 cm, 7"

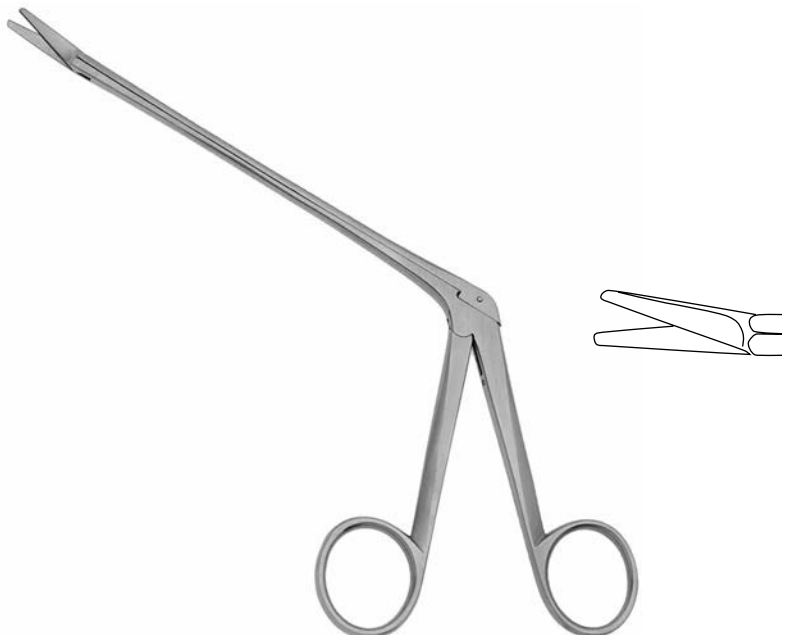

OLIVECRONA

CH-338-23 23,0 cm, 9"

SUPERCUT Scissors

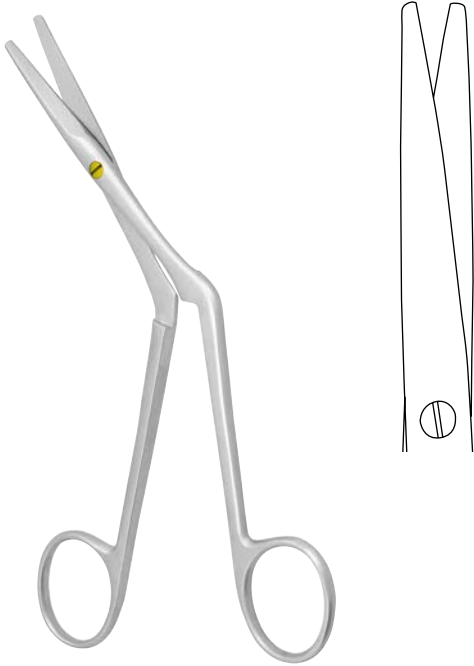

HEYMANN

CH-335-18 SC 18,0 cm, 7"

Nasal scissors



Rongeurs

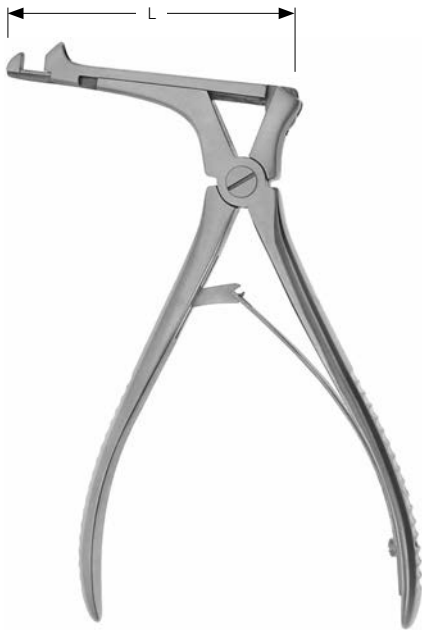

1,0 mm
CH-000-15

2,0 mm
CH-000-22

3,0 mm
CH-000-30
90° cutting upwards

CITELLI

CH-000-15 - CH-000-30 6,5 cm, 2 ½"

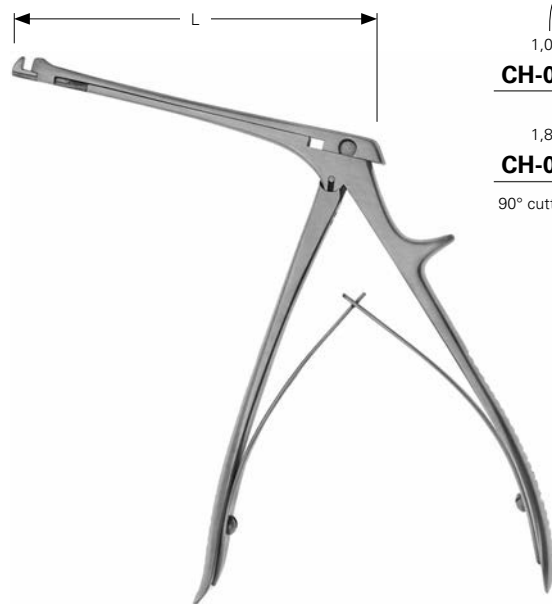

1,0 mm
CH-002-10

1,8 mm
CH-002-18
90° cutting upwards

CITELLI-BEYER

CH-002-10 - CH-002-18 9,5 cm, 3 ¾"



3,0 mm
CH-004-03

4,0 mm
CH-004-04

5,0 mm
CH-004-05

6,0 mm
CH-004-06
90° cutting upwards

KERRISON

CH-004-03 - CH-004-06 9,0 cm, 3 ½"



CH-005-20

HAJEK-CLAUS

CH-005-20 20,0 cm, 8"

Rongeurs

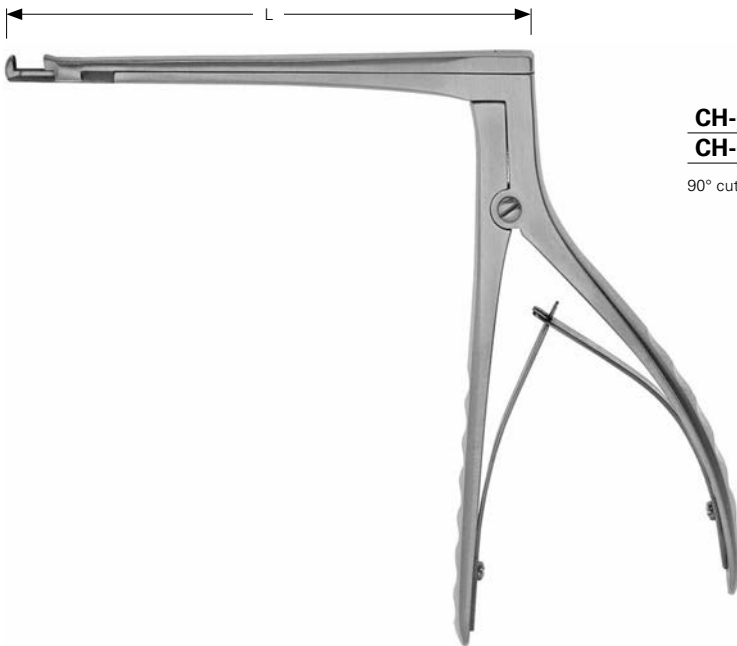

CH-006-33 3,3 mm
CH-006-40 4,0 mm

90° cutting upwards



CH-007-33 3,3 mm
CH-007-40 4,0 mm

90° cutting downwards

HAJEK-KOFLER

CH-006-33 - CH-007-40 14,0 cm, 5 ½"

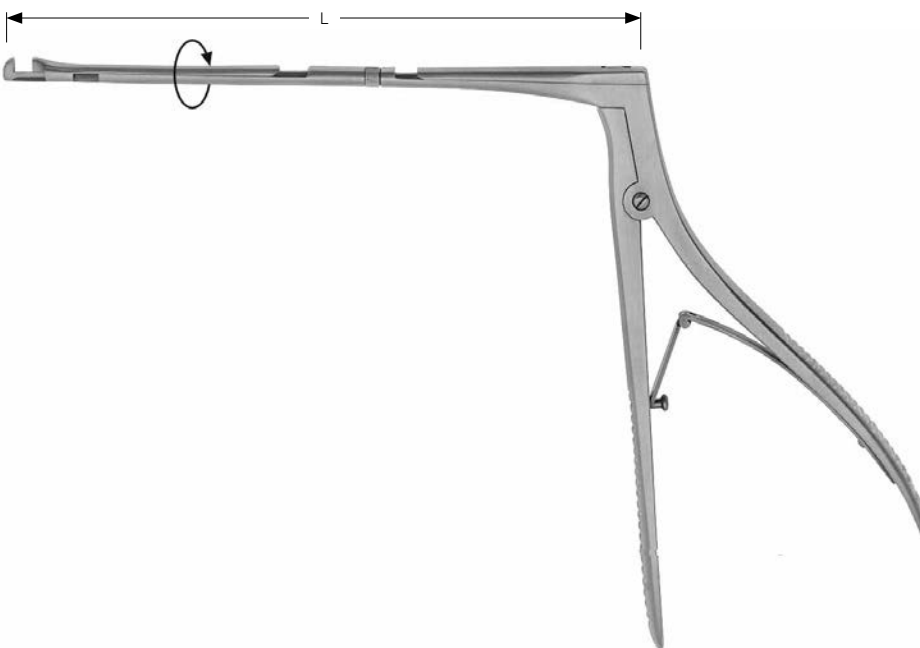

CH-009-40 3,5 mm

90° cutting, shaft rotatable 360°

HAJEK-KOFLER

CH-009-40 17,0 cm, 6 ¾"

Frontal Sinus Punches, Circular Cutting Punches

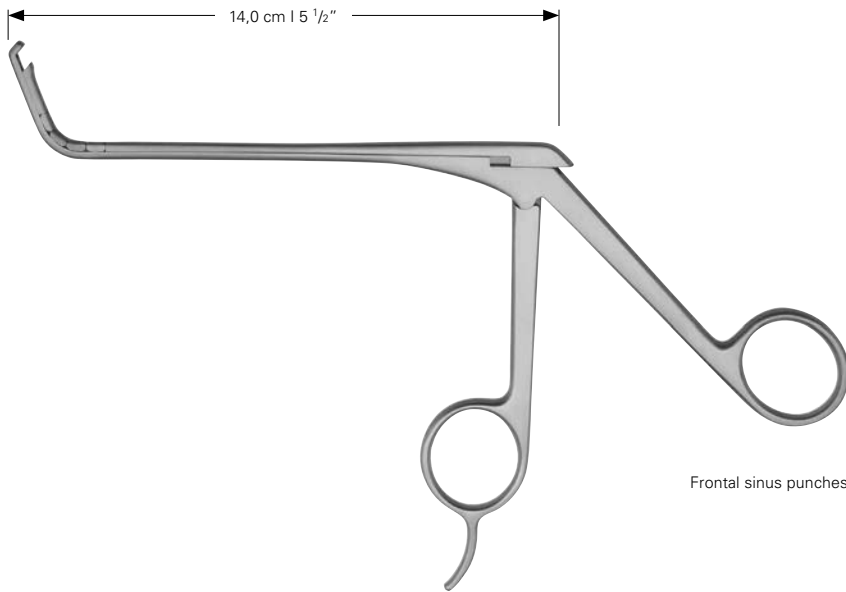

Frontal sinus punches

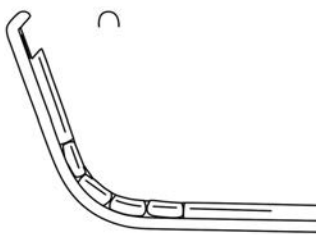

CH-798-02 2,0 x 2,5 mm

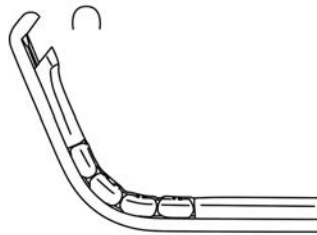

CH-798-03 3,0 x 3,5 mm

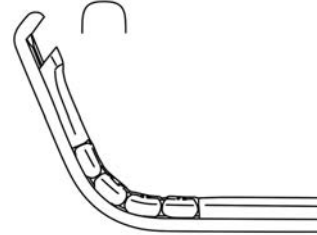

CH-798-05 5,0 x 5,5 mm

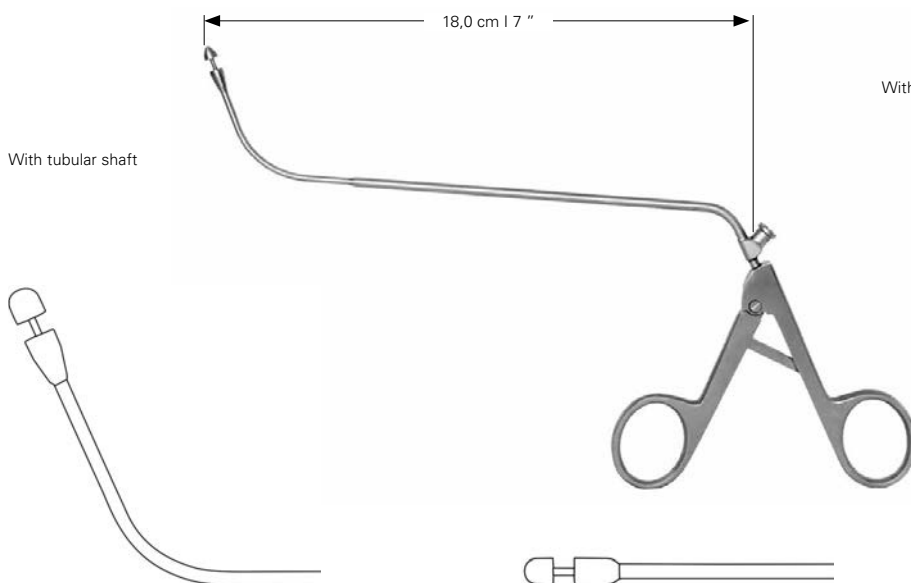

With connection to clean and rinse the shaft

CH-623-35 3,5 mm
CH-623-45 4,5 mm

65° curved upwards, cutting in a full circle of 360°

CH-622-35 3,5 mm
CH-622-45 4,5 mm

Straight, cutting in a full circle of 360°

Antrum Punches, Antrum Grasping Forceps



CH-799-01 LL

Right side downward and forward cutting

CH-799-02 LL

Left side downward and forward cutting

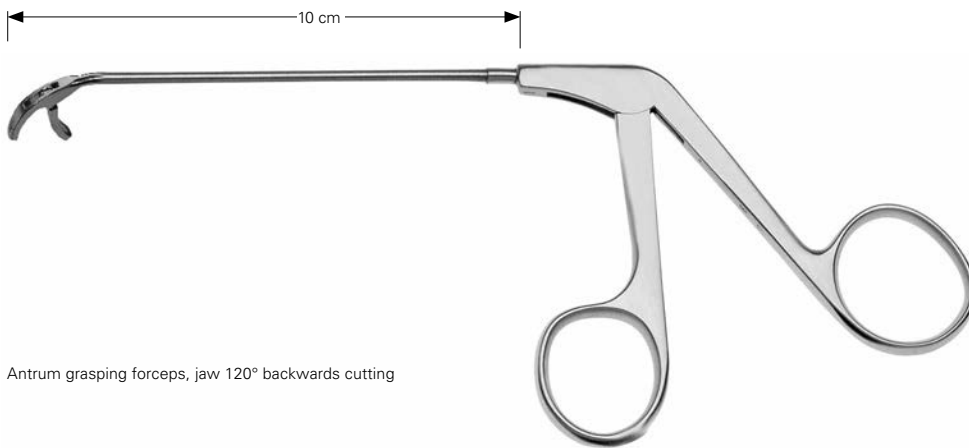

Antrum grasping forceps, jaw 120° backwards cutting

CH-796-24

90° curved up

CH-796-26

90° curved to right

CH-796-28

90° curved to left

CH-796-30

90° curved down



Endoscopic Biopsy- & Grasping Forceps



Flexible

CH-640-00

for Endoscopes 0°, Ø 2.7 mm, **WL. 175.0 mm**

CH-641-00

for Endoscopes 0°, Ø 2.7 mm, **WL. 187.5 mm**

Rigid

CH-642-00

for Endoscopes 0°, Ø 2.7 mm, **WL. 187.5 mm**



Rigid

CH-642-70

for Endoscopes 70°, Ø 2.7 mm, **WL. 187.5 mm**

CH-644-70

for Endoscopes 70°, Ø 4.0 mm, **WL. 175.0 mm**

Biopsy Nasal Forceps, with Luer-Lock Rinsing Channel

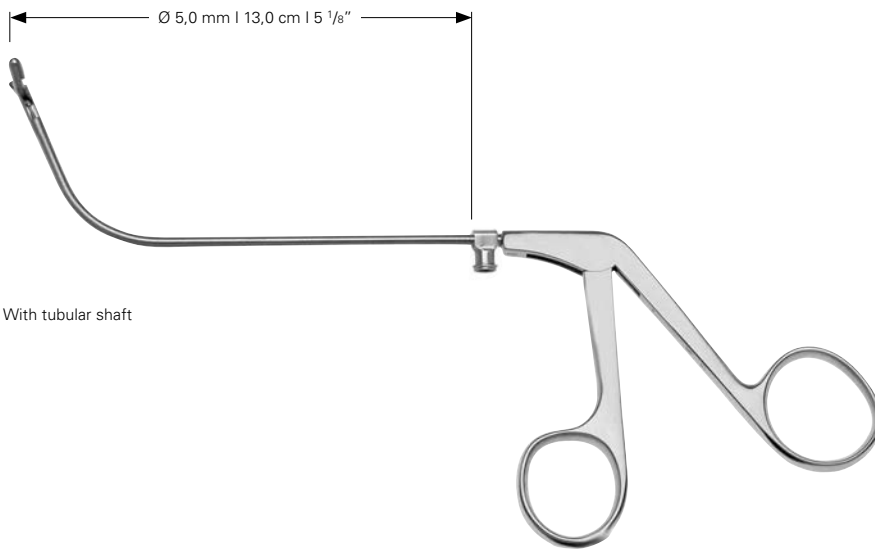

With tubular shaft



CH-610-03 LL 3,0 mm
CH-610-04 LL 4,0 mm

70° curved upwards, vertical opening



CH-611-03 LL 3,0 mm
CH-611-04 LL 4,0 mm

70° curved upwards, horizontal opening

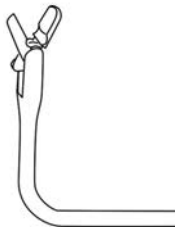

CH-612-03 LL 3,0 mm
CH-612-04 LL 4,0 mm

90° curved upwards, vertical opening

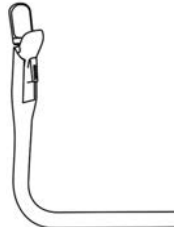

CH-613-03 LL 3,0 mm
CH-613-04 LL 4,0 mm

90° curved upwards, horizontal opening

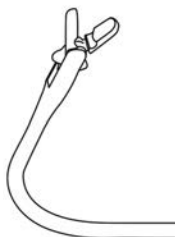

CH-614-03 LL 3,0 mm
CH-614-04 LL 4,0 mm

110° curved upwards, vertical opening

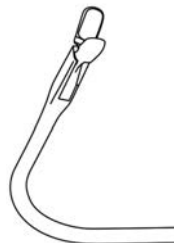

CH-615-03 LL 3,0 mm
CH-615-04 LL 4,0 mm

110° curved upwards, horizontal opening

Septum Forceps

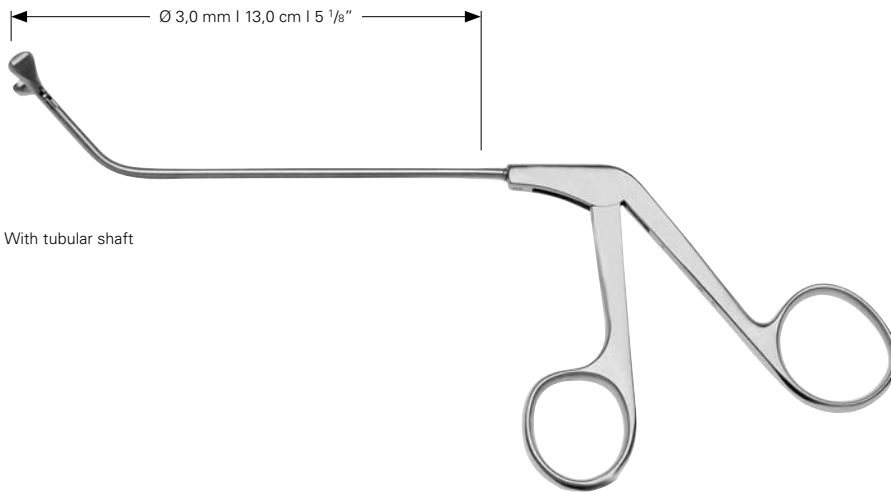

With tubular shaft



CH-621-45

45° curved upwards, horizontal opening

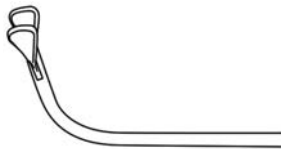

CH-621-80

80° curved upwards, horizontal opening



Septum Forceps, with Luer-Lock Rinsing Channel

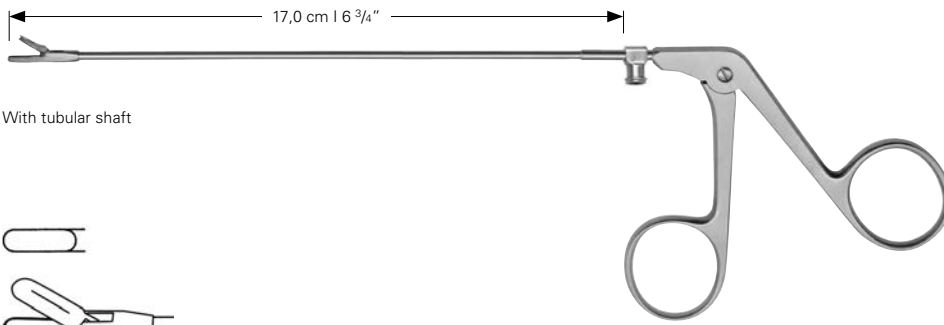

With tubular shaft

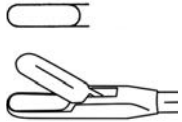

TAKAHASHI

CH-626-17 LL

Straight

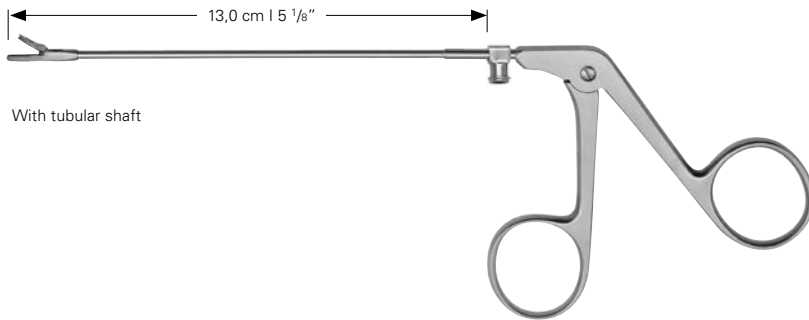

With tubular shaft

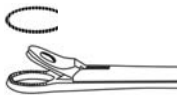

BLAKESLEY

CH-628-00 LL 3,0 mm

CH-628-01 LL 3,5 mm

CH-628-02 LL 4,0 mm

Straight, through cutting

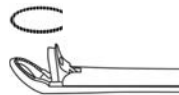

BLAKESLEY

CH-629-00 LL 3,0 mm

CH-629-01 LL 3,5 mm

CH-629-02 LL 4,0 mm

Curved up 45°, through cutting



Septum Forceps

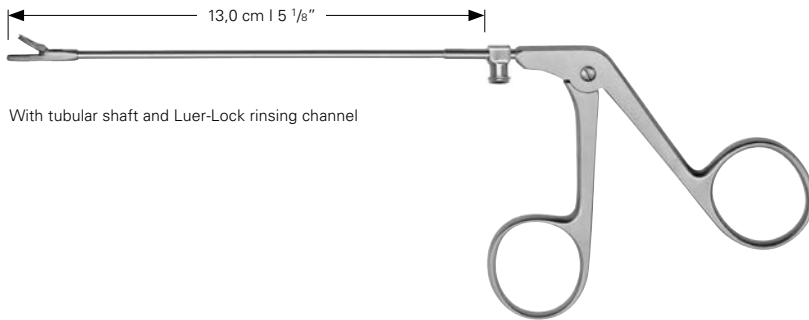

With tubular shaft and Luer-Lock rinsing channel



GRUENWALD

CH-630-01 LL 8,0 x 3,0 mm

CH-630-02 LL 12,0 x 3,0 mm

Straight, through cutting



GRUENWALD

CH-631-01 LL 8,0 x 3,0

CH-631-01 LL 12,0 x 3,0 mm

Curved up 45°, through cutting

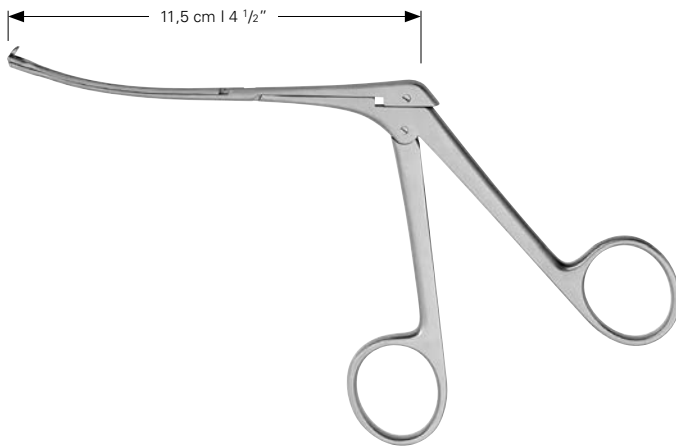

CH-655-01 2,5 mm

Curved downwards, retrograde cutting for children



CH-655-03 3,6 mm

Curved downwards, retrograde cutting for adults



CH-655-02 2,5 mm

Curved upwards, retrograde cutting for children

Septum Forceps

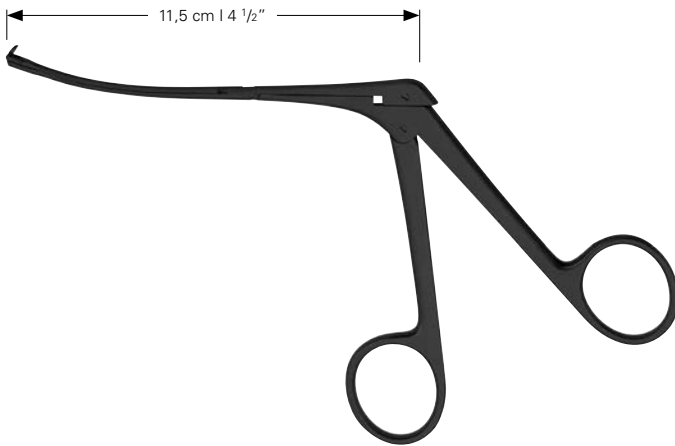

CH-655-01 B 2,5 mm
Curved downwards, retrograde cutting for children



CH-655-03 B 3,6 mm
Curved downwards, retrograde cutting for adults



CH-655-02 B 2,5 mm
Curved upwards, retrograde cutting for children

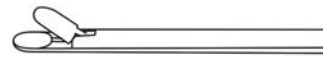
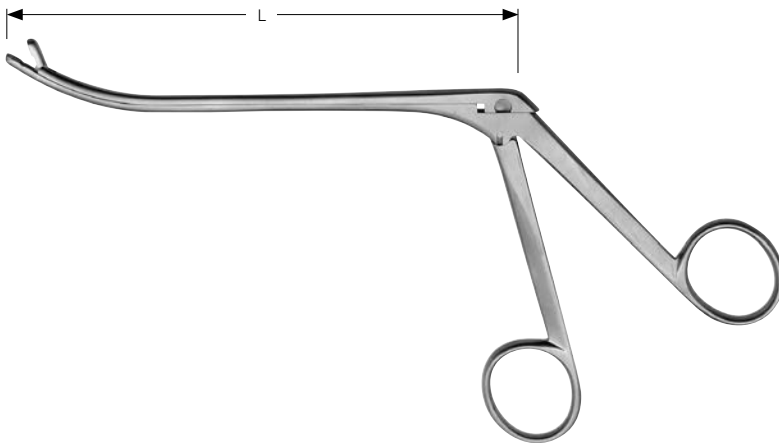

JIKEI
CH-650-04 14,0 cm, 5 1/2"
Fig. 4, straight, delicate, oval

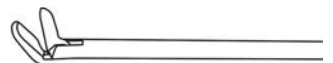

JIKEI
CH-650-05 14,0 cm, 5 1/2"
Fig. 5, curved up, delicate, oval

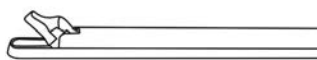

JIKEI
CH-650-01 14,0 cm, 5 1/2"
Fig. 1, straight, delicate, through cutting



JIKEI
CH-650-02 14,0 cm, 5 1/2"
Fig. 2, curved up, delicate, through cutting



JIKEI
CH-650-03 14,0 cm, 5 1/2"
Fig. 3, curved up, delicate, through cutting



JIKEI
CH-650-06 14,0 cm, 5 1/2"
Fig. 6, curved up, delicate, oval

Septum Forceps

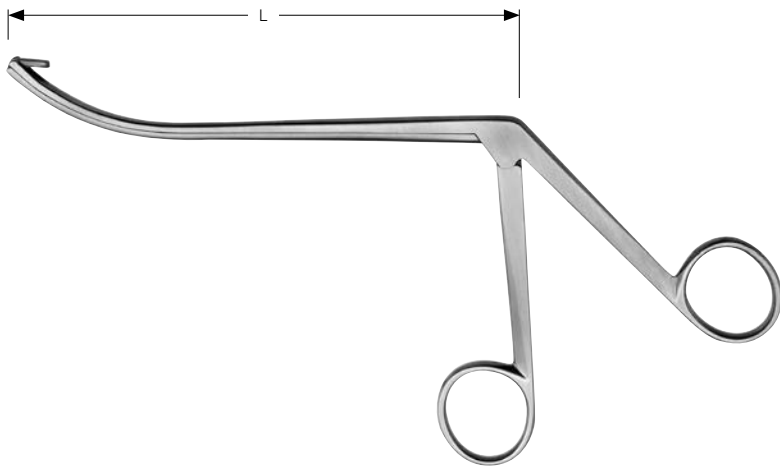

JIKEI
CH-650-07 14,0 cm, 5 1/2 "
 Fig. 7, curved up, retrograde cutting



JIKEI
CH-650-08 14,0 cm, 5 1/2 "
 Fig. 8, curved up, through cutting

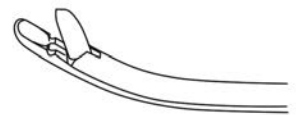

JIKEI
CH-650-09 14,0 cm, 5 1/2 "
 Fig. 9, curved up, oval

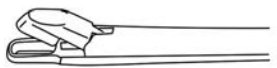

JIKEI
CH-650-10 11,5 cm, 4 1/2 "
 Fig. 10, straight, small, through cutting

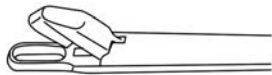

JIKEI
CH-650-11 11,5 cm, 4 1/2 "
 Fig. 11, straight, large, through cutting

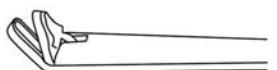

JIKEI
CH-650-13 11,5 cm, 4 1/2 "
 Fig. 13, curved up, medium, through cutting



JIKEI
CH-650-14 11,5 cm, 4 1/2 "
 Fig. 14, curved up, large, through cutting

Nasal Forceps

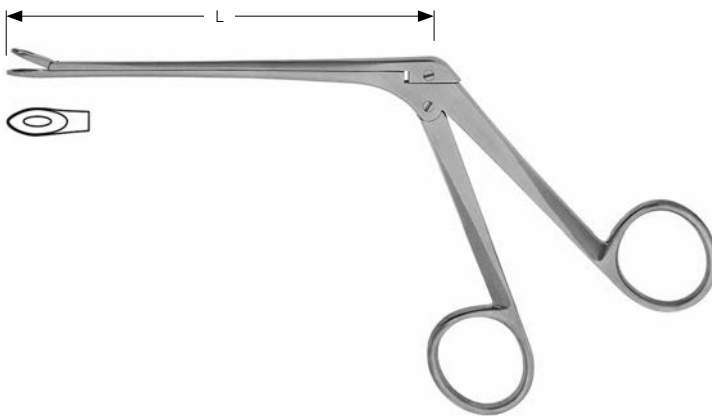

WEIL-BLAKESLEY



| | | | | |
|--------|----------------|------------------|------------------|------------------|
| 3,0 mm | 120 mm, 4 3/4" | CH-036-30 | CH-037-30 | CH-038-30 |
| 3,6 mm | 120 mm, 4 3/4" | CH-036-36 | CH-037-36 | CH-038-36 |
| 4,2 mm | 120 mm, 4 3/4" | CH-036-42 | CH-037-42 | CH-038-42 |
| 4,8 mm | 120 mm, 4 3/4" | CH-036-48 | CH-037-48 | CH-038-48 |
| 5,2 mm | 120 mm, 4 3/4" | CH-036-58 | CH-037-58 | CH-038-58 |

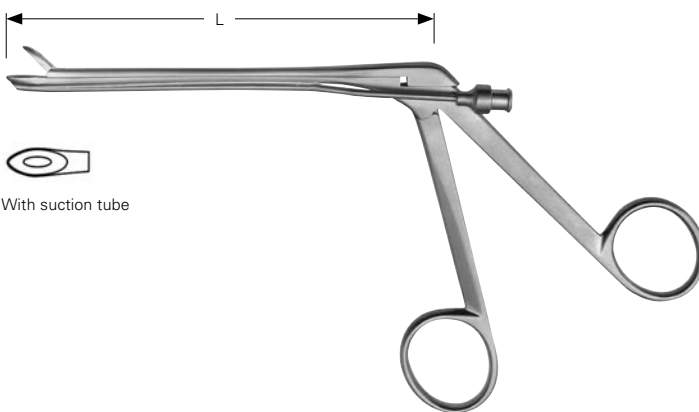

With suction tube

WEIL-BLAKESLEY



| | | | | |
|--------|----------------|--------------------|--------------------|--------------------|
| 2,5 mm | 120 mm, 4 3/4" | CH-036-30 A | CH-037-30 A | |
| 3,6 mm | 120 mm, 4 3/4" | CH-036-36 A | CH-037-36 A | CH-038-36 A |

Nasal Forceps



CH-043-01
Curved up 45°

WATSON-WILLIAMS

CH-043-01 12,0 cm, 4 3/4"

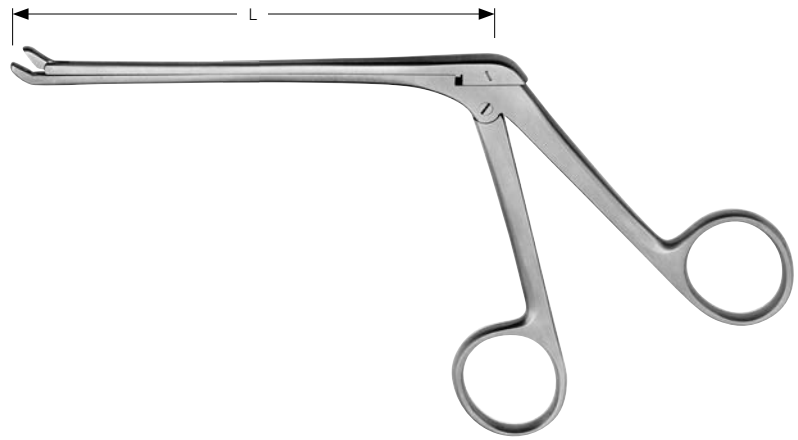

3,0 mm
CH-044-03
Straight



5,0 mm
CH-044-05
Straight



3,0 mm
CH-045-03
Curved up 45°

TAKAHASHI

CH-044-03 - CH-045-03 12,0 cm, 4 3/4"

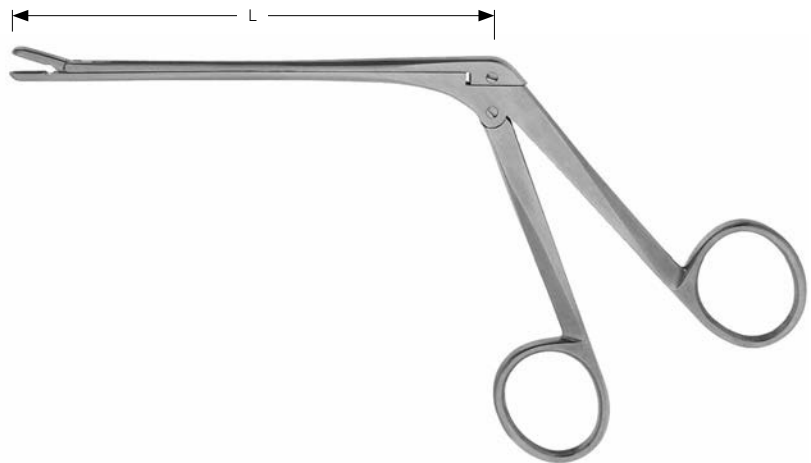

2,0 mm
CH-046-00
Straight

BECK

CH-046-00 13,0 cm, 5 1/2"



Nasal Forceps, Nasal Scissors

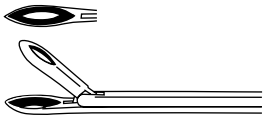
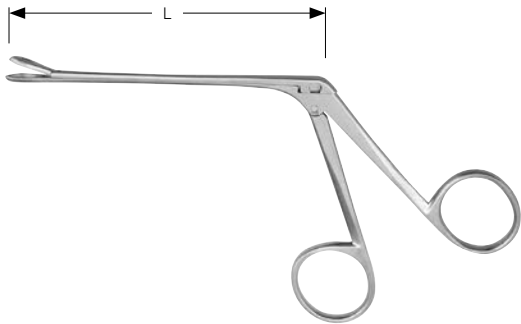

STRUEMPEL

CH-230-08 8,5 cm, 3 1/3 "
CH-230-18 12,5 cm, 5 "

Spoon forceps, oval



STRUEMPEL

CH-230-19 12,5 cm, 5 "

Spoon forceps, oval, 45°



STRUEMPEL

CH-230-20 12,5 cm, 5 "

Spoon forceps, oval, 90°

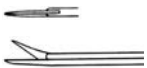
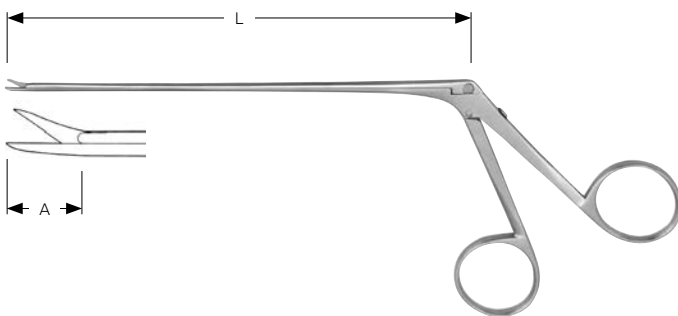

L = 12,5 cm, 5 "

BELLUCCI

CH-412-11 A = 4,5 mm

Straight



L = 15,0 cm, 6 "

BELLUCCI

CH-412-15 A = 4,5 mm

Straight

Antrum Punches, Rongeurs

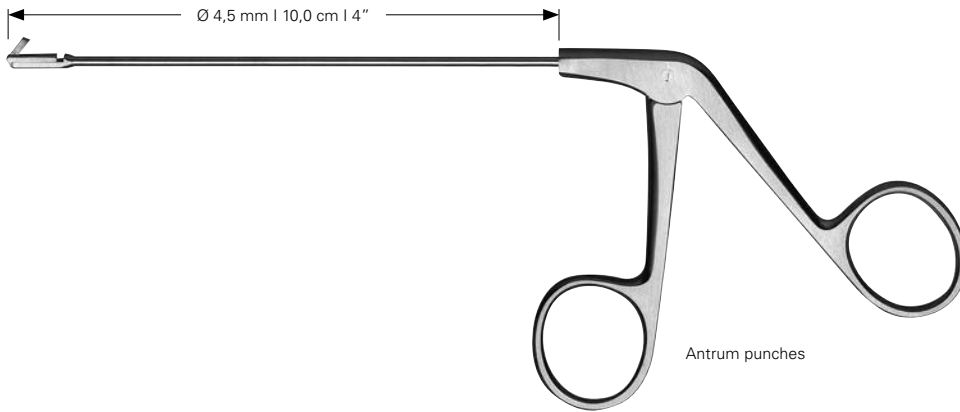

Antrum punches

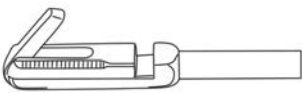

CH-794-00 2,5 x 6,5 mm
Cutting upwards

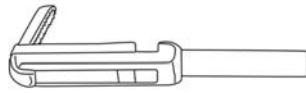

CH-794-01 2,5 x 6,5 mm
Cutting right

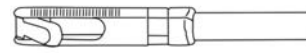

CH-794-02 2,5 x 6,5 mm
Cutting left

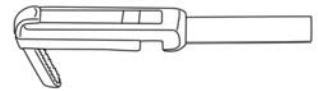

CH-794-03 2,5 x 6,5 mm
Cutting downwards

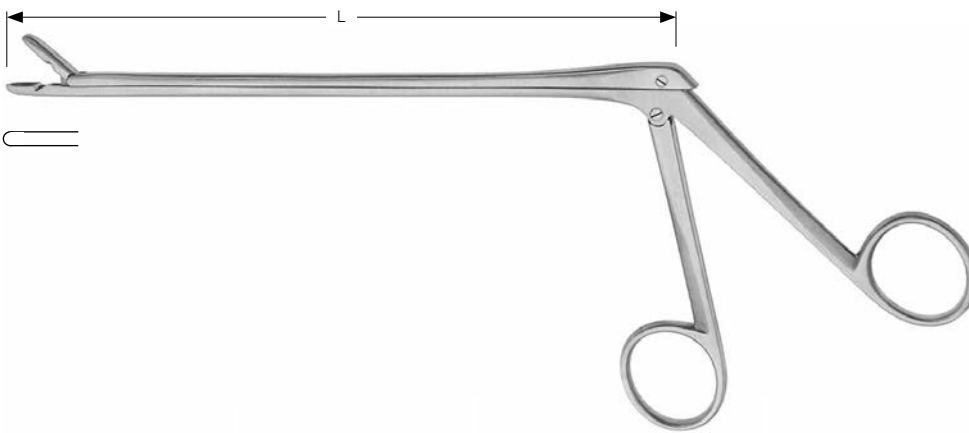

CUSHING

Width of bite

Length of shaft



Straight



Curved up 30°

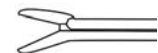

Curved down 30°

| | | | | |
|---------------|-------------|------------------|------------------|------------------|
| 2,0 x 10,0 mm | 130 mm, 5 " | CH-046-02 | CH-047-02 | CH-049-02 |
| 2,0 x 10,0 mm | 150 mm, 6 " | CH-050-02 | CH-051-02 | CH-053-02 |
| 2,0 x 10,0 mm | 180 mm, 7 " | CH-066-02 | CH-067-02 | CH-069-02 |
| 2,0 x 10,0 mm | 200 mm, 8 " | CH-066-12 | CH-067-12 | CH-069-12 |
| 2,0 x 10,0 mm | 230 mm, 9 " | CH-066-22 | | |

Antrum Punches, Rongeurs



WATSON-WILLIAMS

CH-043-01 12,0 cm, 4 3/4"
Curved up 45°

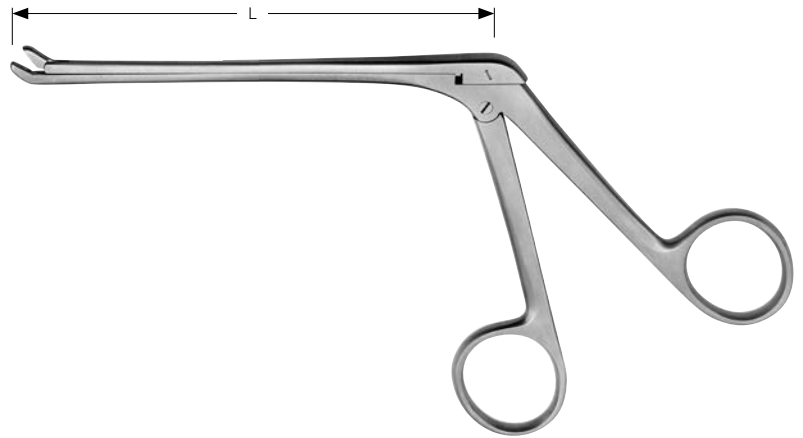

3,0 mm
CH-044-03
Straight



5,0 mm
CH-044-05
Straight



3,0 mm
CH-045-03
Curved up 45°

TAKAHASHI

CH-044-03 - CH-045-03 12,0 cm, 4 3/4"

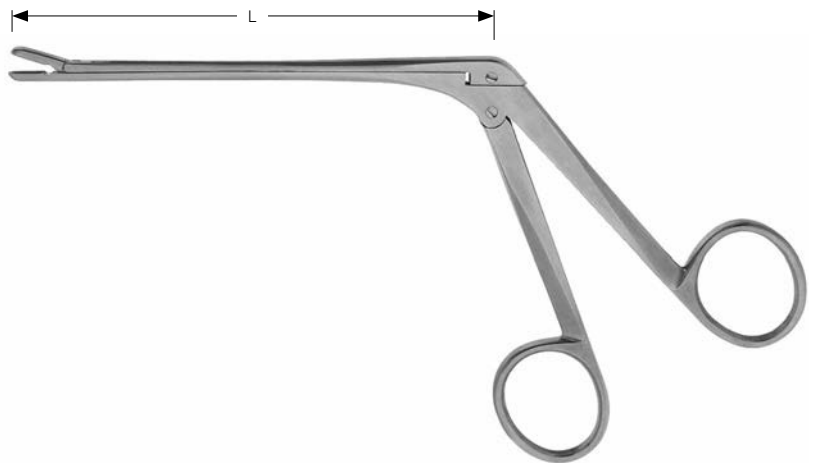

2,0 mm

BECK

CH-046-00 13,0 cm, 5 1/2"
Straight



Nasal Forceps and Rongeurs



Easy handling and safe disassembling of the sliding shaft instruments for perfect cleaning

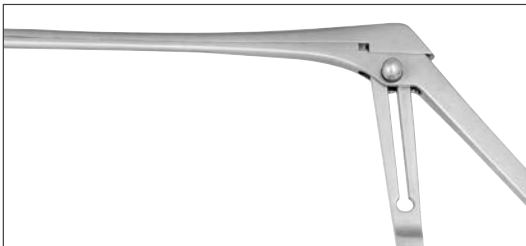

When instrument closed push the spring-loaded button

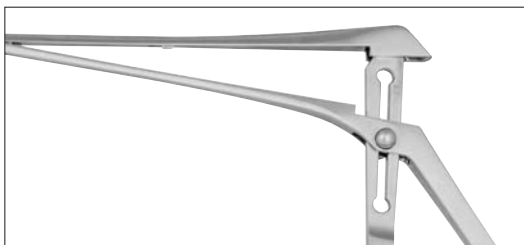

Push the pressed button down and open the branches



Open branches enables an optimal cleaning of the instrument

Nasal Speculas



Fig. 1

CH-500-08



Fig. 2

CH-500-09



Fig. 3

CH-500-12



Fig. 4

CH-500-15



Fig. 5

CH-500-16



Fig. 6

CH-500-18

Self-retaining

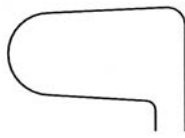

Fig. 7

CH-500-19

THUDICHUM

CH-500-08 - CH-500-19 6,5 cm, 2 1/2"

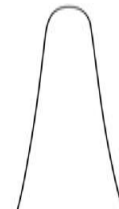

Fig. 1

CH-504-01

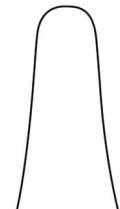

Fig. 2

CH-504-02

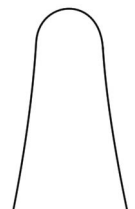

Fig. 3

CH-504-03



Self-retaining, spread adjustable by set screw

VOLTOLINI

CH-504-01 - CH-504-03



Fig. 1

CH-506-01

For infants



Fig. 2

CH-506-02

For babies



With aseptic joint (dismantable)

TIECK-HALLE

CH-506-01 - CH-506-02 13,5 cm, 5 1/4"



Fig. 2

CH-506-22

For babies



With aseptic joint (dismantable)

TIECK-HALLE

CH-506-22 13,5 cm, 5 1/4"

Nasal Speculas



Fig. 1

CH-507-01

for infants

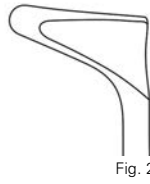

Fig. 2

CH-507-02

for babies



With screw joint

TIECK-HALLE

CH-507-01 - CH-507-02 13,5 cm, 5 ¼"

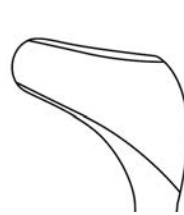

Fig. 1

CH-508-01

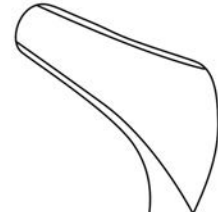

Fig. 2

CH-508-02



With aseptic joint (dismantable)

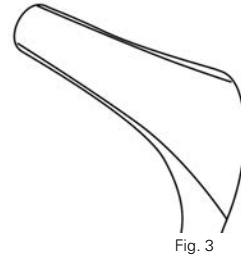

Fig. 3

CH-508-03

HARTMANN-HALLE

CH-508-01 - CH-508-03 15,5 cm, 6 ⅛"



Fig. 1

CH-509-01

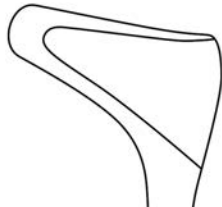

Fig. 2

CH-509-02



With screw joint

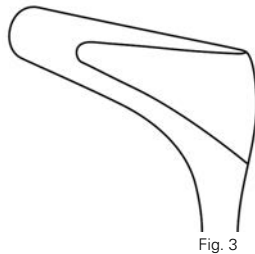

Fig. 3

CH-509-03

HARTMANN-HALLE

CH-509-01 - CH-509-03 15,5 cm, 6 ⅛"

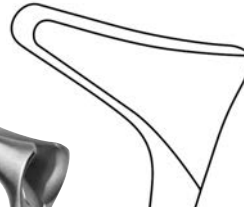

Fig. 1

CH-513-01

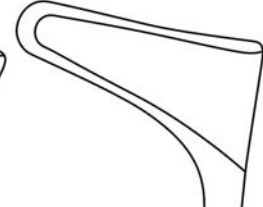

Fig. 2

CH-513-02



With screw joint

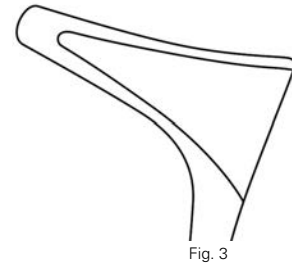

Fig. 3

CH-513-03

HARTMANN

CH-513-01 - CH-513-03 16,0 cm, 6 ¼"

Nasal Speculas

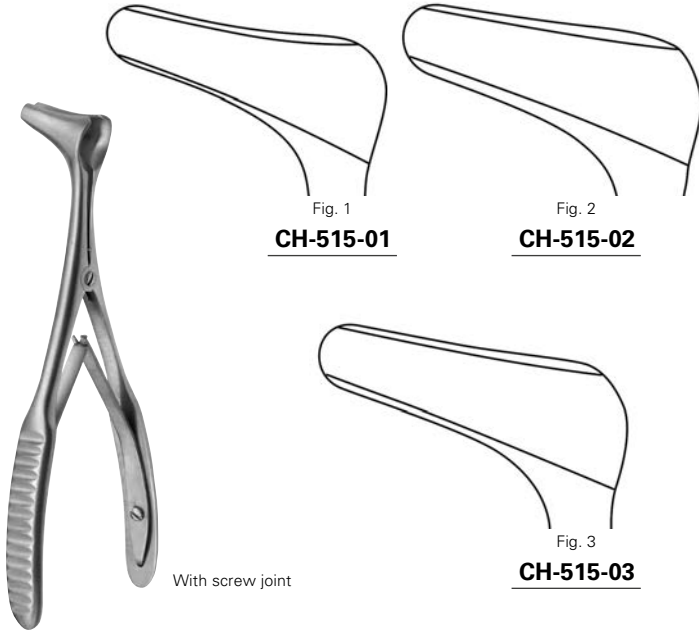

Fig. 1
CH-515-01

Fig. 2
CH-515-02

Fig. 3
CH-515-03

With screw joint

MOD. WIEN

CH-515-01 - CH-515-03 14,0 cm, 5 1/2"

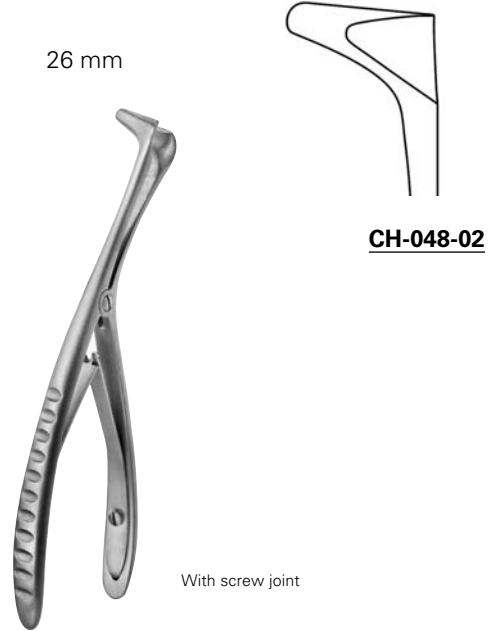

26 mm

CH-048-02

With screw joint

BECKMANN

CH-048-02 14,0 cm, 5 1/2"

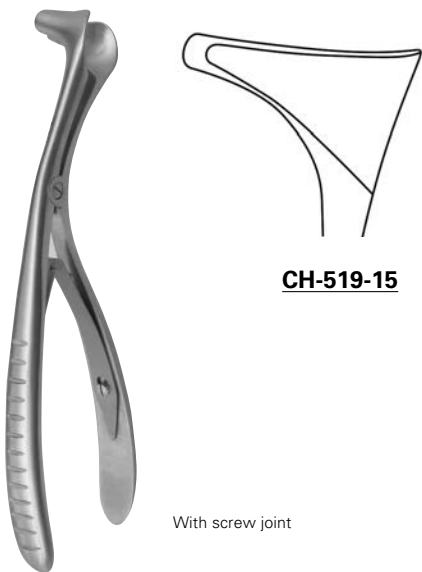

CH-519-15

With screw joint

BECKMANN

CH-519-15 15,0 cm, 6"



CH-521-14

With screw joint

HARTMANN

CH-521-14 14,5 cm, 5 3/4"

Nasal Speculas



With aseptic joint (dismantable)

KILLIAN

CH-524-01 - CH-524-05 14,0 cm, 5 ½ "

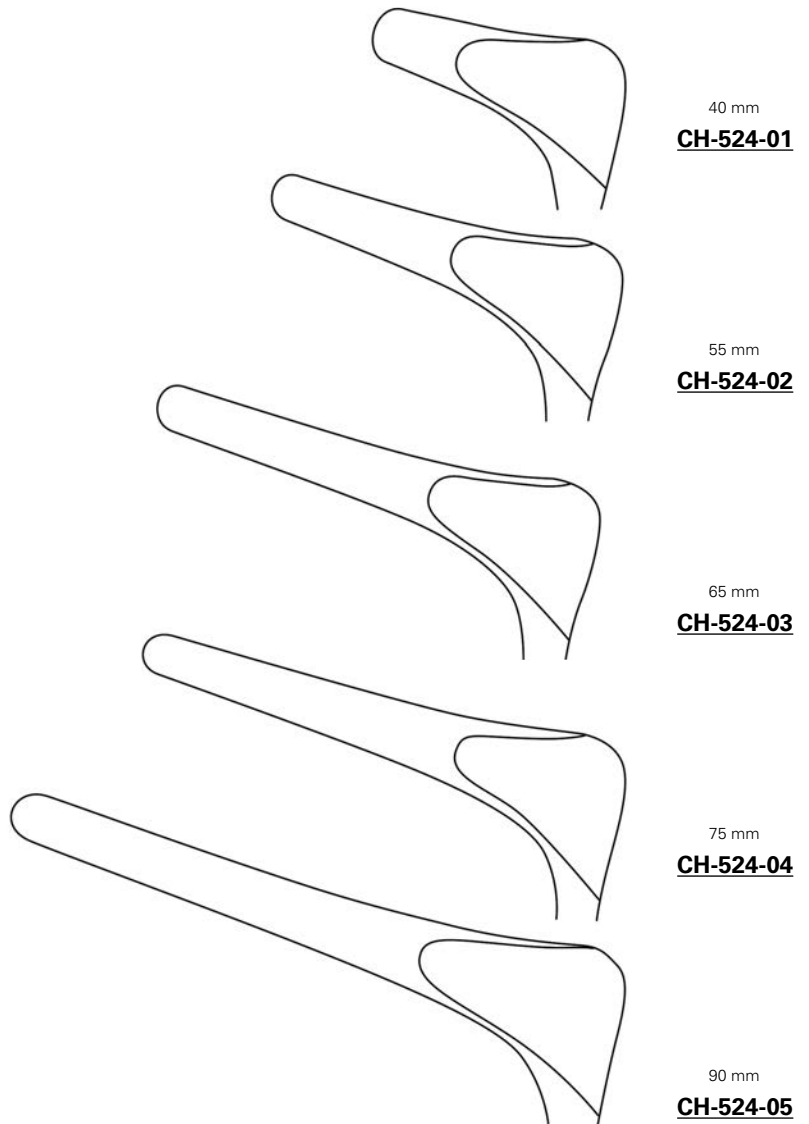

Nasal Speculas



KARL STORZ
OLYMPUS
ACMI
RICHARD WOLF

With aseptic joint (dismantable) and fibre optic light carrier

KILLIAN

CH-524-01 KL - CH-524-04 KL 14,0 cm, 5 ½"

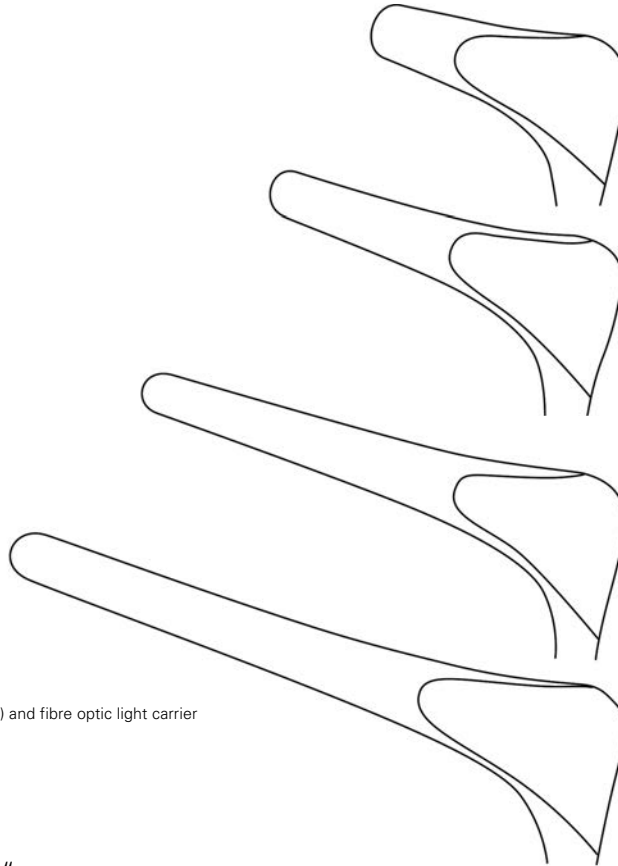

40 mm
CH-524-01 KL

55 mm
CH-524-02 KL

75 mm
CH-524-03 KL

90 mm
CH-524-04 KL



With aseptic joint (dismantable)

KILLIAN

CH-524-11 - CH-524-14 14,0 cm, 5 ½"

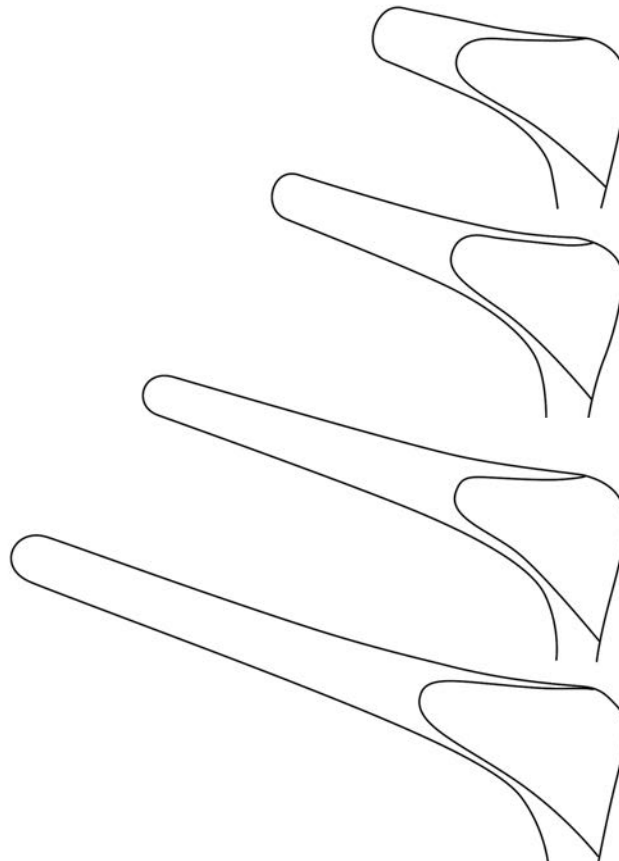

40 mm
CH-524-11

55 mm
CH-524-12

75 mm
CH-524-13

90 mm
CH-524-14

Nasal Speculas



Adaption for flexible arm



With aseptic joint (dismantable)

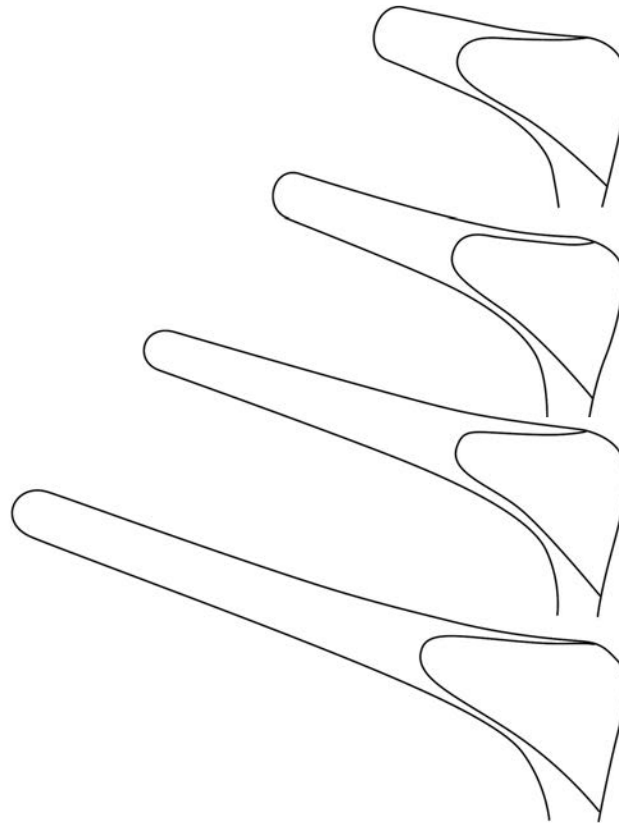

40 mm
CH-524-21

55 mm
CH-524-22

75 mm
CH-524-23

90 mm
CH-524-24

KILLIAN

CH-524-21 - CH-524-24 14,0 cm, 5 1/2 "



Adaption for flexible arm



With aseptic joint (dismantable)

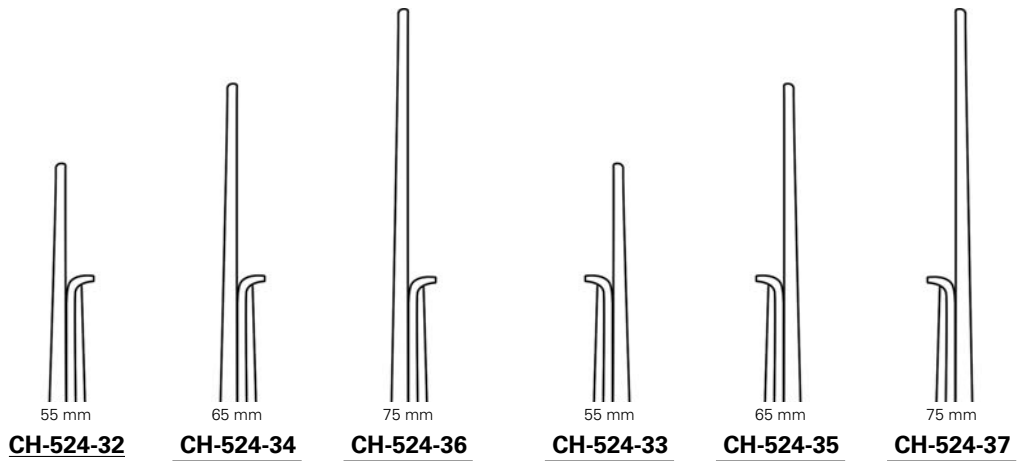

CH-524-32

CH-524-34

CH-524-36

CH-524-33

CH-524-35

CH-524-37

Right blade shortened with teeth

Left blade shortened with teeth

KILLIAN-RUDERT

CH-524-32 - CH-524-37 14,0 cm, 5 1/2 "

Nasal Speculas



With screw joint

KILLIAN

CH-525-01 - CH-525-04 14,0 cm, 5 ½ "

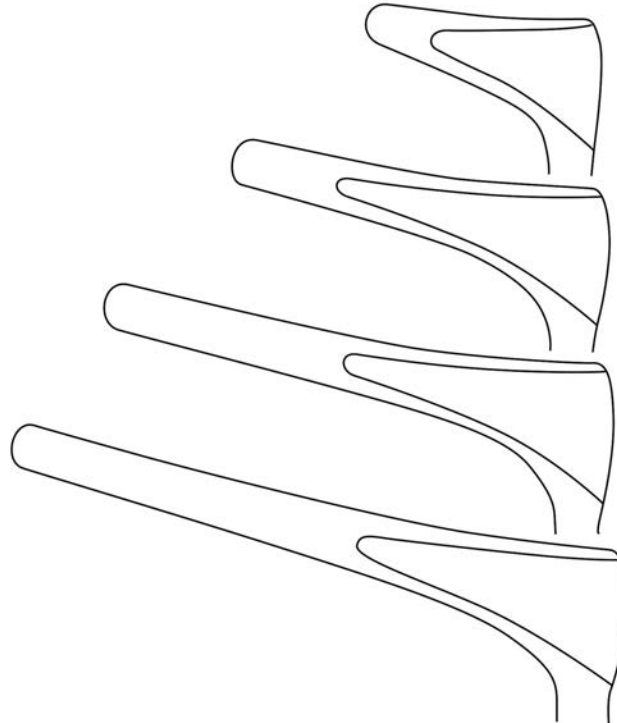

40 mm
CH-525-01

55 mm
CH-525-02

75 mm
CH-525-03

90 mm
CH-525-04



With aseptic joint (dismantable)

COTTLE

CH-528-01 - CH-528-04 15,0 cm, 6 "

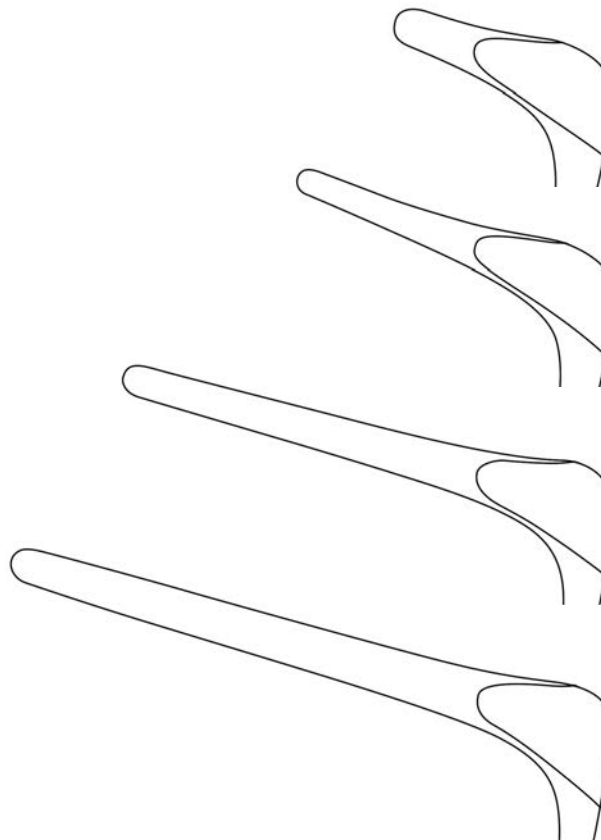

35 mm
CH-528-01

55 mm
CH-528-02

75 mm
CH-528-03

90 mm
CH-528-04

Nasal Speculas



With aseptic joint (dismantable)

COTTLE

CH-529-01 - CH-529-04 15,0 cm, 6 "

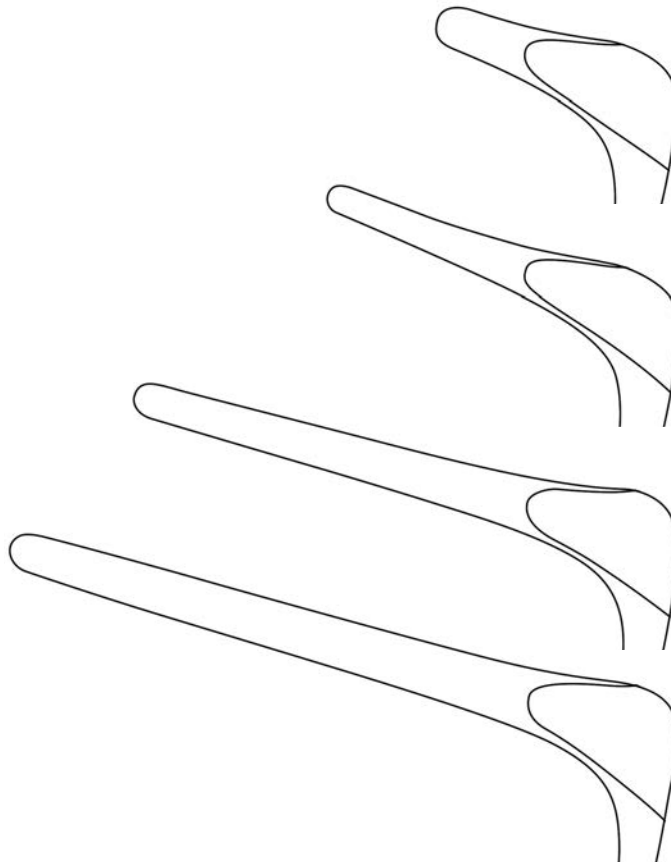

35 mm
CH-529-01

55 mm
CH-529-02

75 mm
CH-529-03

90 mm
CH-529-04



With screw joint

COTTLE

CH-530-01 - CH-530-04 14,0 cm, 5 ½ "

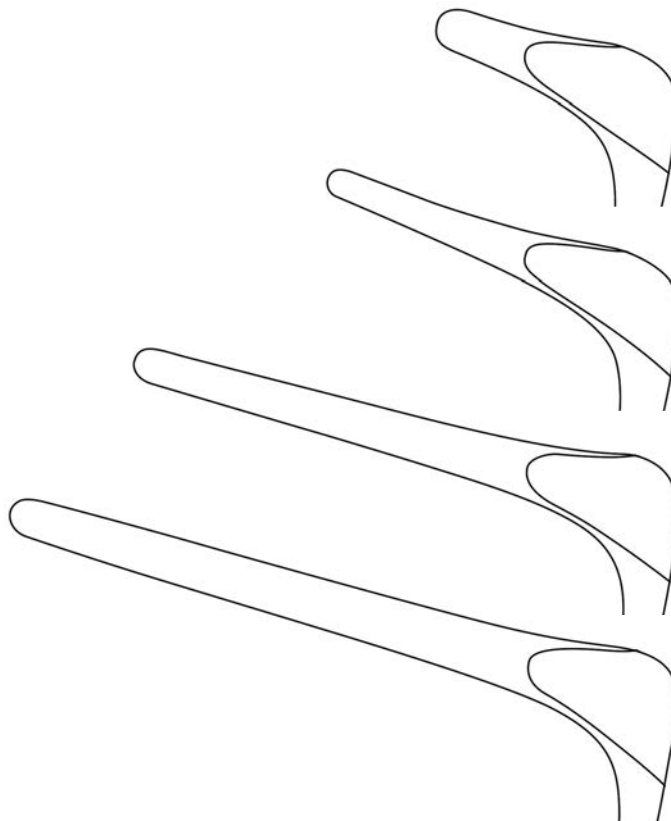

35 mm
CH-530-01

50 mm
CH-530-02

75 mm
CH-530-03

90 mm
CH-530-04

Nasal Speculas



50 x 6 mm
CH-532-13

With aseptic joint (dismantable)

COTTLE

CH-532-13 13,0 cm, 5 3/4 "



50 x 6 mm
CH-533-13

With aseptic joint (dismantable)

COTTLE

CH-533-13 13,0 cm, 5 3/4 "



75 x 60 mm
CH-535-01

Right blade shortened

With aseptic joint (dismantable)

COTTLE

CH-535-01 15,0 cm, 6 "



60 x 75 mm
CH-535-02

Left blade shortened

With aseptic joint (dismantable)

COTTLE

CH-535-02 15,0 cm, 6 "

Retractors

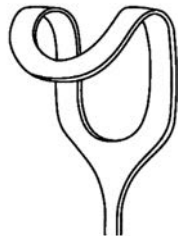

26 x 30 mm
CH-035-03



20 x 22 mm
CH-035-02



14 x 17 mm
CH-035-01



MIDDENDORPF

- CH-035-01** 21,5 cm, 8 1/2"
- CH-035-02** 22,0 cm, 8 3/4"
- CH-035-03** 23,5 cm, 9 1/2"



LANGENBECK

- CH-018-01 - CH-018-07** 22,5 cm, 8 3/4"



50 x 11 mm
CH-018-07

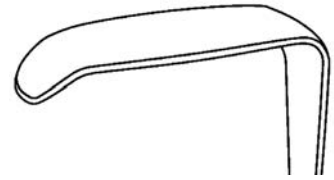

40 x 13 mm
CH-018-06



40 x 11 mm
CH-018-05

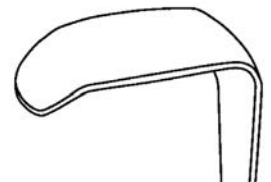

33 x 14 mm
CH-018-04

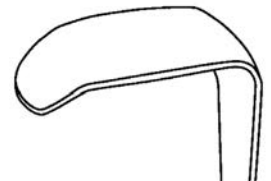

30 x 16 mm
CH-018-03

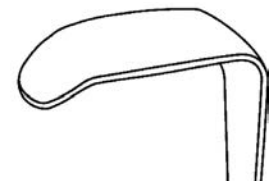

30 x 14 mm
CH-018-02

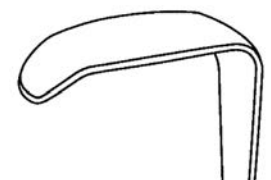

30 x 11 mm
CH-018-01

Spatula, Lip Retractors



Malleable

| | |
|------------------|-------------|
| CH-074-01 | 200 x 6 mm |
| CH-074-02 | 200 x 8 mm |
| CH-074-03 | 200 x 10 mm |
| CH-074-04 | 200 x 12 mm |
| CH-074-05 | 200 x 17 mm |
| CH-074-06 | 200 x 25 mm |
| CH-074-07 | 250 x 25 mm |



STERNBERG

| | |
|------------------|-----------------|
| CH-070-12 | 12,0 cm, 4 3/4" |
| CH-070-14 | 14,0 cm, 5 1/2" |
| CH-070-16 | 16,0 cm, 6 1/4" |





Rhinology and Rhinoplasty



Table of Content I Chapter



















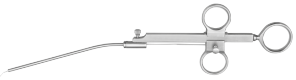

| Product group | Page |
|--|----------------|
|  <p>Nasal Specula and Accessories</p> | 157-166 |
|  <p>Nasal Dressing Forceps</p> | 167 |
|  <p>Suction Tubes</p> | 168 |
|  <p>Retractors, Cotton Applicators</p> | 169 |
|  <p>Bipolar Forceps with Irrigation</p> | 170-177 |
|  <p>Tampon and Polypus Forceps</p> | 178-179 |
|  <p>Powder Blowers</p> | 180 |
|  <p>Polypus Snares</p> | 181 |
|  <p>Nasal Scissors, Biopsy- & Grasping Forceps, Nasal Scissors</p> | 182-191 |
|  <p>Nasal Forceps, Nasal Cutting Forceps, Rongeurs</p> | 192-193 |

Table of Content I Chapter



| Product group | Page |
|---|--|
|  | <p>Septum Forceps, Vomer Forceps, Gelfoam Forceps</p> <p style="text-align: right;">194-198</p> |
|  | <p>Septum Scissors</p> <p style="text-align: right;">199</p> |
|  | <p>Swivel Knives, Elevators, Raspatories</p> <p style="text-align: right;">200</p> |
|  | <p>Septum Gouges, Osteotomes, Chisels, Sharpening Stones</p> <p style="text-align: right;">206-211</p> |
|  | <p>Mallets</p> <p style="text-align: right;">212</p> |
|  | <p>Rhinoplastic Knives, Scalpel Handles and Blades</p> <p style="text-align: right;">213-215</p> |
|  | <p>Nasal Retractors, Alar Nasal Hooklets</p> <p style="text-align: right;">216-218</p> |
|  | <p>Delicate Surgical and Dissecting Scissors</p> <p style="text-align: right;">219-222</p> |
|  | <p>Nasal Rasps and Saws</p> <p style="text-align: right;">223</p> |
|  | <p>Cartilage Crusher, Forceps, Measuring Instruments</p> <p style="text-align: right;">230-231</p> |

Nasal Speculas



Fig. 1

CH-500-08



Fig. 2

CH-500-09



Fig. 3

CH-500-12



Fig. 4

CH-500-15



Fig. 5

CH-500-16



Fig. 6

CH-500-18

Self-retaining

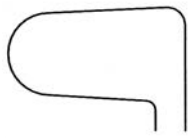

Fig. 7

CH-500-19

THUDICHUM

CH-500-08 - CH-500-19 6,5 cm, 2 1/2"

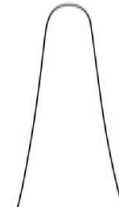

Fig. 1

CH-504-01

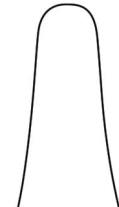

Fig. 2

CH-504-02

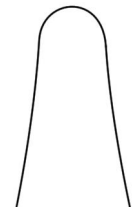

Fig. 3

CH-504-03



Self-retaining, spread adjustable by set screw

VOLTOLINI

CH-504-01 - CH-504-03



Fig. 1

CH-506-01

For infants



Fig. 2

CH-506-02

For babies



With aseptic joint (dismantable)

TIECK-HALLE

CH-506-01 - CH-506-02 13,5 cm, 5 1/4"



Fig. 2

CH-506-22

For babies



With aseptic joint (dismantable)

TIECK-HALLE

CH-506-22 13,5 cm, 5 1/4"

Nasal Speculas



Fig. 1

CH-507-01

For infants

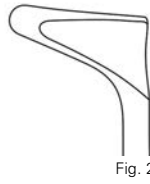

Fig. 2

CH-507-02

For babies



With screw joint

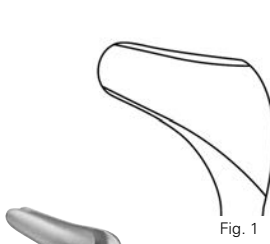

Fig. 1

CH-508-01

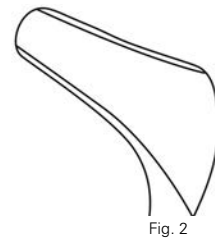

Fig. 2

CH-508-02



With aseptic joint (dismantable)

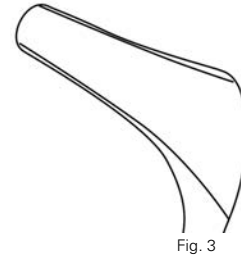

Fig. 3

CH-508-03

TIECK-HALLE

CH-507-01 - CH-507-02 13,5 cm, 5 ¼"

HARTMANN-HALLE

CH-508-01 - CH-508-03 15,5 cm, 6 ⅞"



Fig. 1

CH-509-01

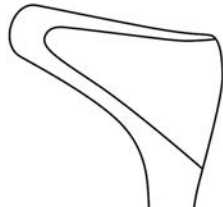

Fig. 2

CH-509-02



With screw joint

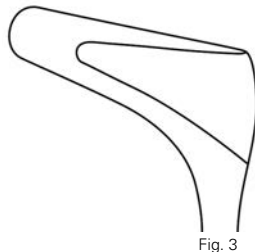

Fig. 3

CH-509-03

HARTMANN-HALLE

CH-509-01 - CH-509-03 15,5 cm, 6 ⅞"

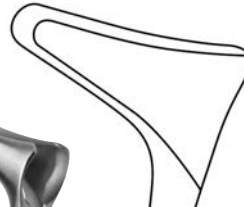

Fig. 1

CH-513-01

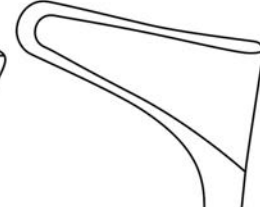

Fig. 2

CH-513-02



With screw joint

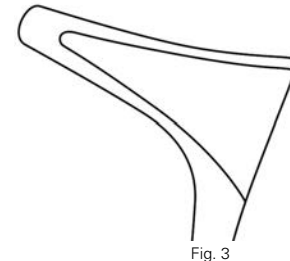

Fig. 3

CH-513-03

HARTMANN

CH-513-01 - CH-513-03 16,0 cm, 6 ¼"

Nasal Speculas

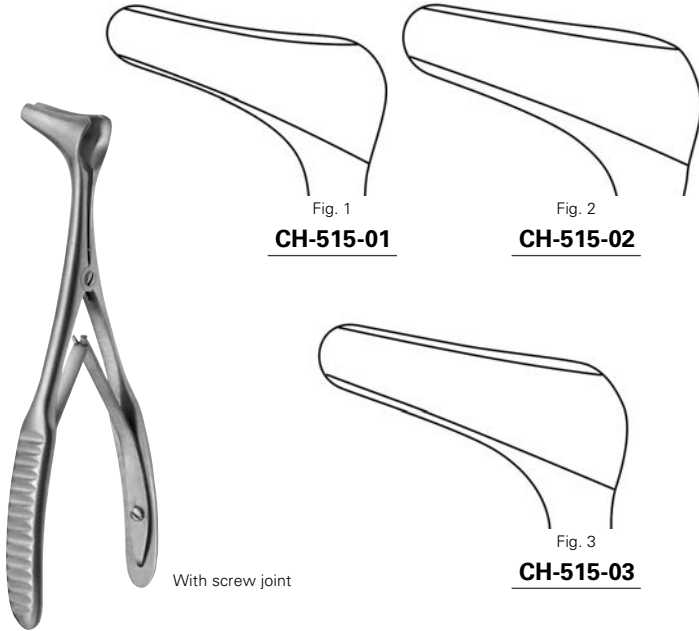

MOD. WIEN
CH-515-01 - CH-515-03 14,0 cm, 5 ½"

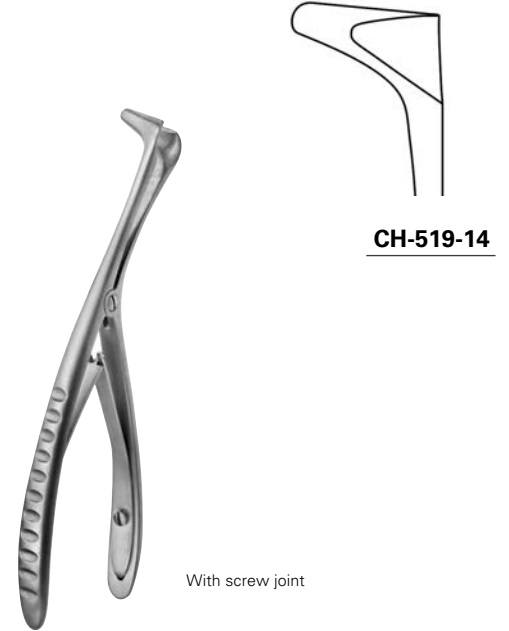

BECKMANN
CH-519-14 14,0 cm, 5 ½"

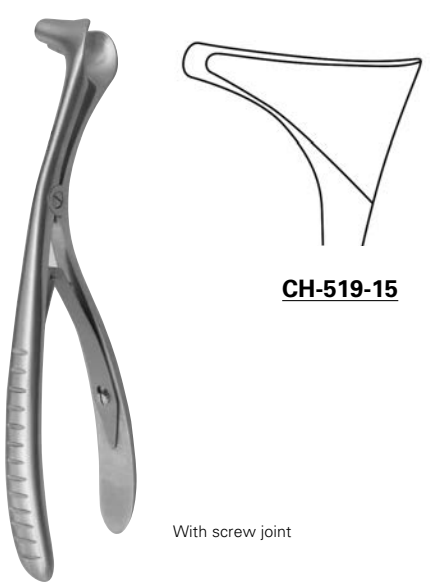

BECKMANN
CH-519-15 15,0 cm, 6"



HARTMANN
CH-521-14 14,5 cm, 5 ¾"

Nasal Speculas



With aseptic joint (dismantable)

KILLIAN

CH-524-01 - CH-524-05 14,0 cm, 5 1/2"

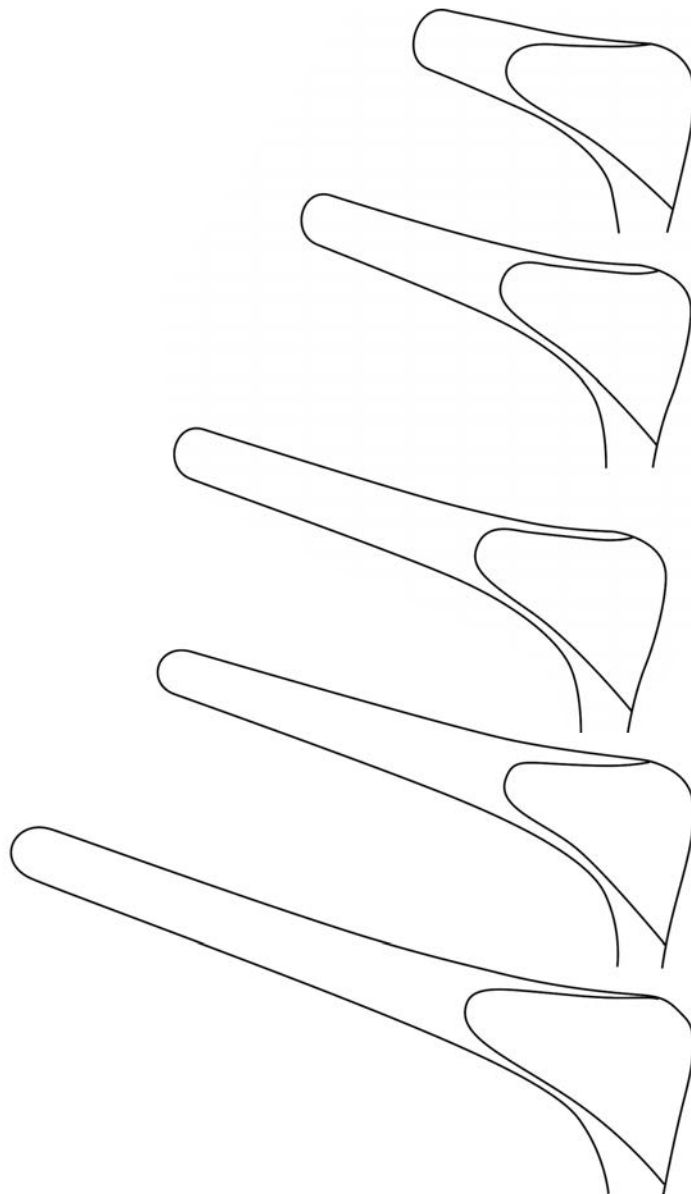

40 mm
CH-524-01

55 mm
CH-524-02

65 mm
CH-524-03

75 mm
CH-524-04

90 mm
CH-524-05



Nasal Speculas



SKILL
KARL STORZ
OLYMPUS
ACMI
RICHARD WOLF

With aseptic joint (dismantable) and fibre optic light carrier

KILLIAN

CH-524-01 KL - CH-524-04 KL 14,0 cm, 5 ½"

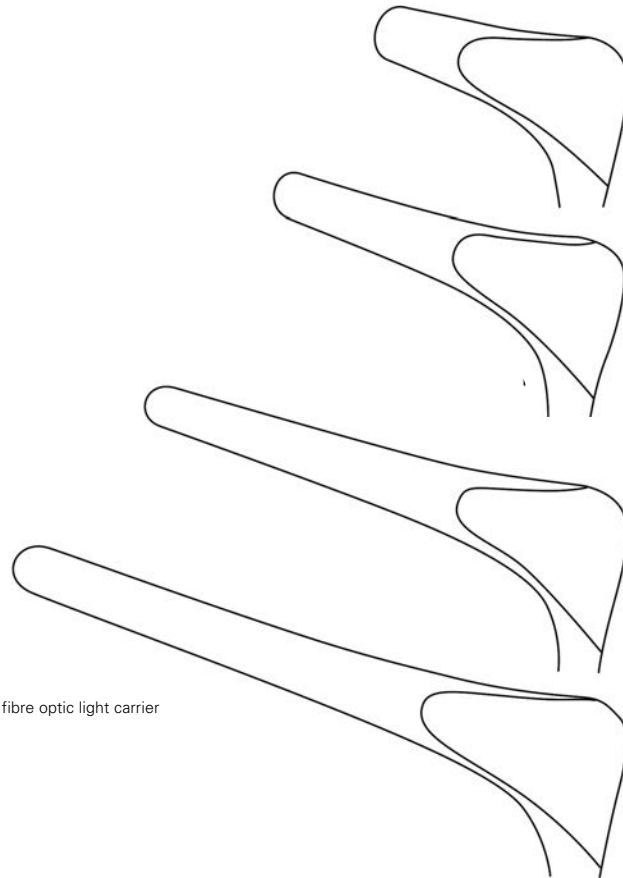

40 mm
CH-524-01 KL

55 mm
CH-524-02 KL

75 mm
CH-524-03 KL

90 mm
CH-524-04 KL



With aseptic joint (dismantable)

KILLIAN

CH-524-11 - CH-524-14 14,0 cm, 5 ½"

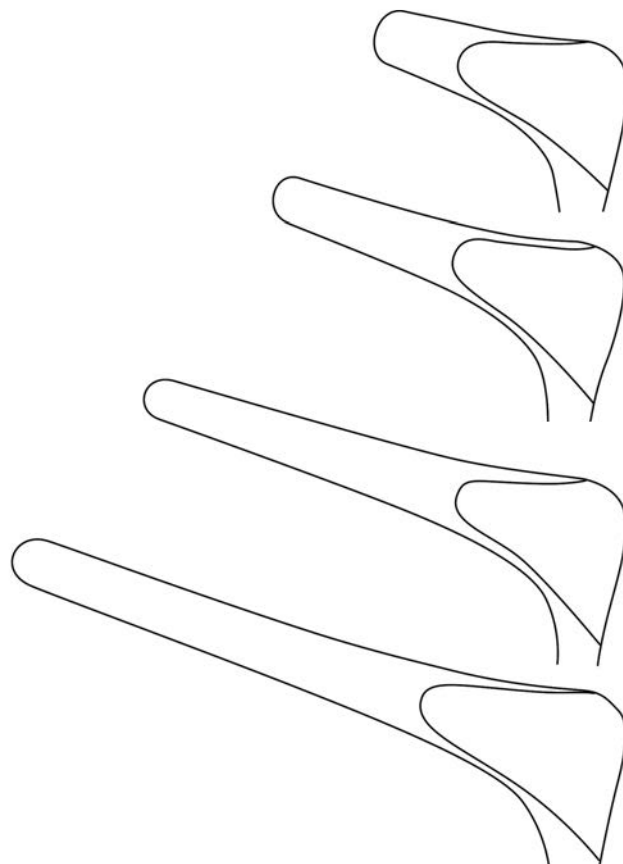

40 mm
CH-524-11

55 mm
CH-524-12

75 mm
CH-524-13

90 mm
CH-524-14

Nasal Speculas



Adaption for flexible arm



With aseptic joint (dismantable)

KILLIAN

CH-524-21 - CH-524-24 14,0 cm, 5 1/2"

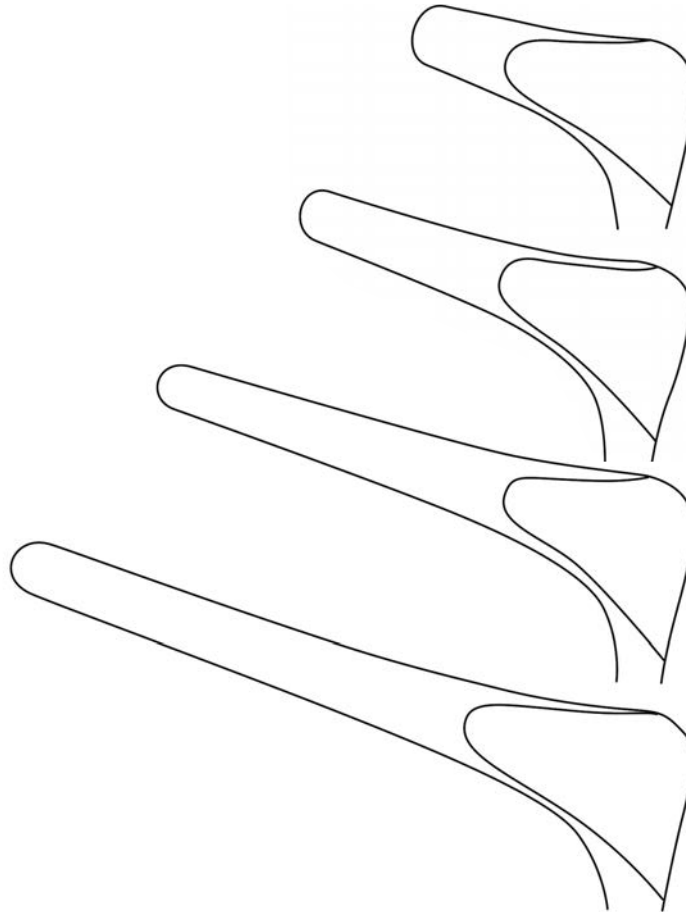

40 mm
CH-524-21

55 mm
CH-524-22

75 mm
CH-524-23

90 mm
CH-524-24



Adaption for flexible arm



With aseptic joint (dismantable)

KILLIAN-RUDERT

CH-524-32 - CH-524-37 14,0 cm, 5 1/2"

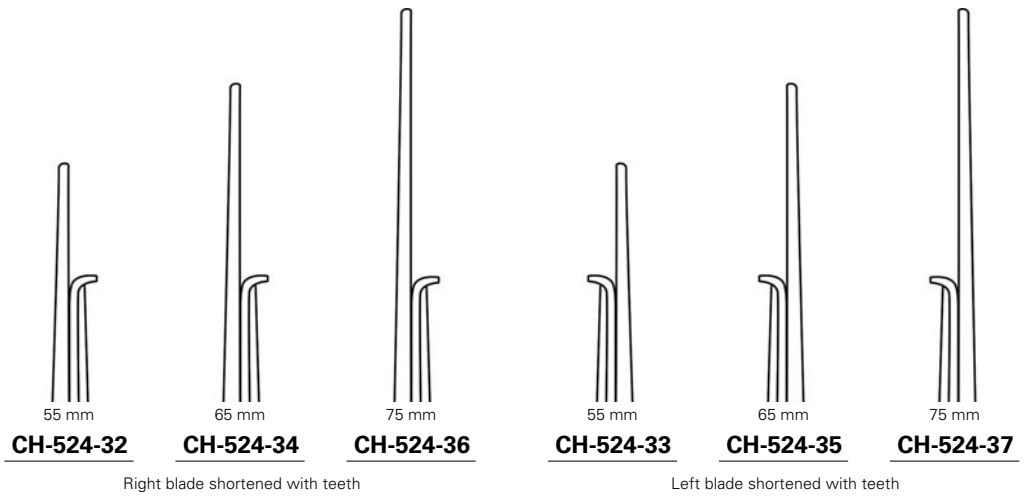

55 mm
CH-524-32

65 mm
CH-524-34

75 mm
CH-524-36

55 mm
CH-524-33

65 mm
CH-524-35

75 mm
CH-524-37

Right blade shortened with teeth

Left blade shortened with teeth

Nasal Speculas



With screw joint

KILLIAN

CH-525-01 - CH-525-04 14,0 cm, 5 ½ "

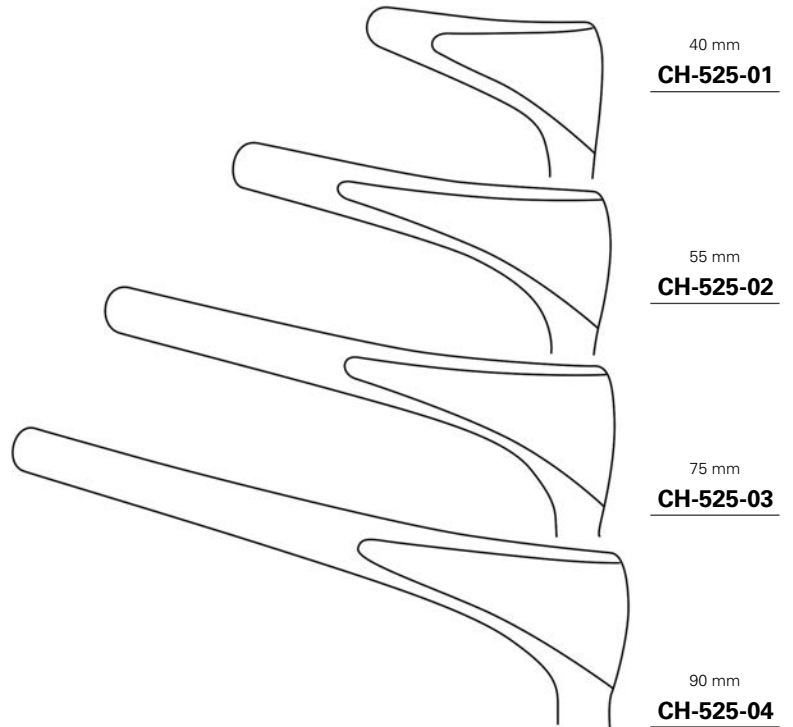

40 mm
CH-525-01

55 mm
CH-525-02

75 mm
CH-525-03

90 mm
CH-525-04



With aseptic joint (dismantable)

COTTLE

CH-528-01 - CH-528-04 15,0 cm, 6 "

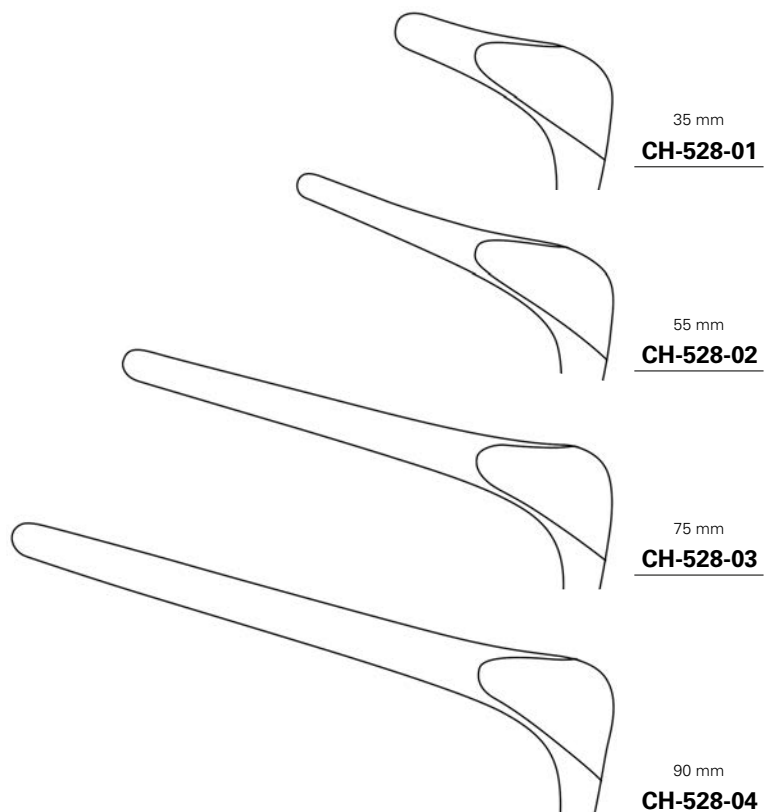

35 mm
CH-528-01

55 mm
CH-528-02

75 mm
CH-528-03

90 mm
CH-528-04

Nasal Speculas



With aseptic joint (dismantable)

COTTLE

CH-529-01 - CH-529-04 15,0 cm, 6"

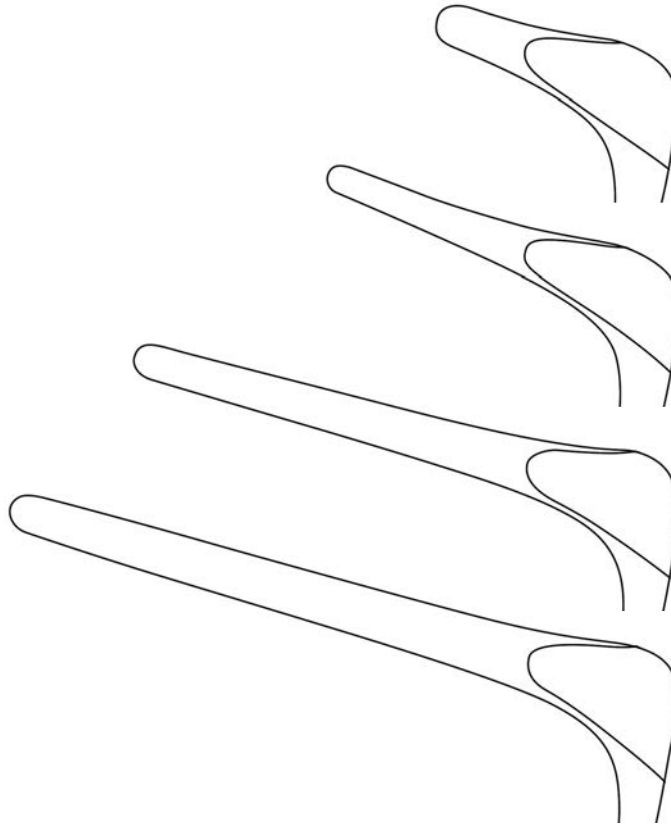

35 mm
CH-529-01

55 mm
CH-529-02

75 mm
CH-529-03

90 mm
CH-529-04



With screw joint

COTTLE

CH-530-01 - CH-530-04 14,0 cm, 5 ½"

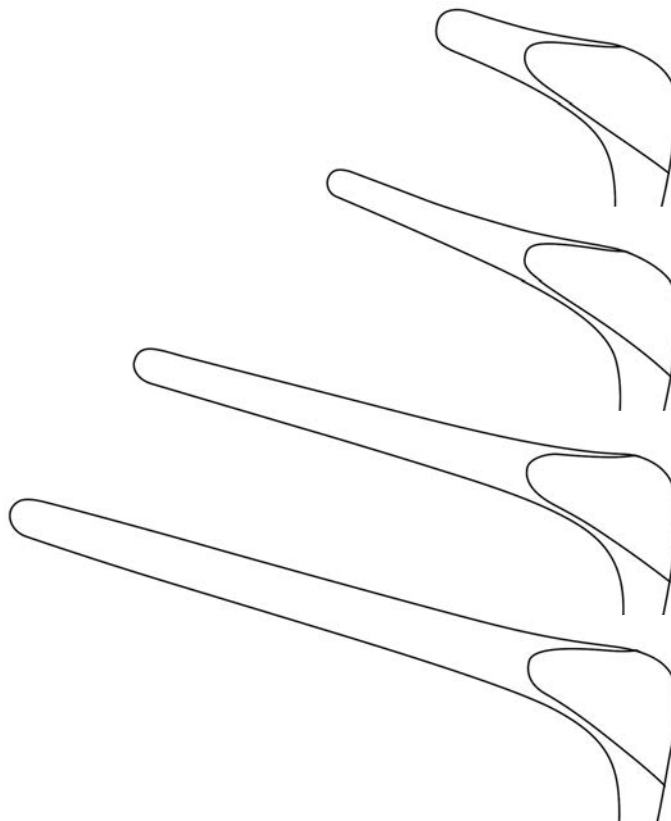

35 mm
CH-530-01

50 mm
CH-530-02

75 mm
CH-530-03

90 mm
CH-530-04

Nasal Speculas



COTTLE

CH-532-13 13,0 cm, 5 3/4"



COTTLE

CH-533-13 13,0 cm, 5 3/4"



COTTLE

CH-535-01 15,0 cm, 6"



COTTLE

CH-535-02 15,0 cm, 6"

Nasal Dressing Forceps

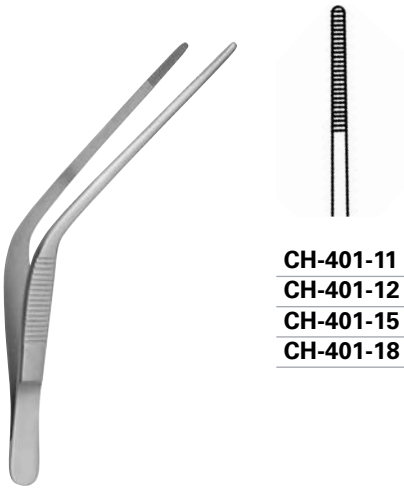

CH-401-11
CH-401-12
CH-401-15
CH-401-18

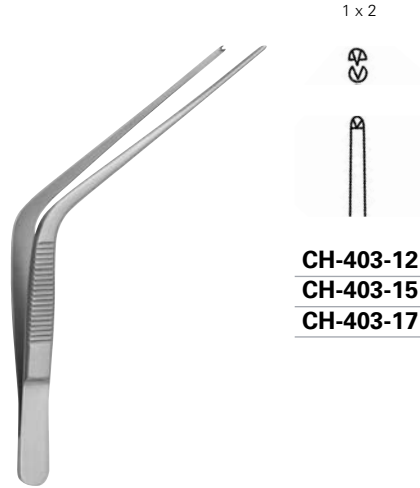

CH-403-12
CH-403-15
CH-403-17

TROELTSCH

| | |
|------------------|----------------------------|
| CH-401-11 | 11,0 cm, 4 $\frac{3}{8}$ " |
| CH-401-12 | 12,0 cm, 4 $\frac{3}{4}$ " |
| CH-401-15 | 15,0 cm, 6" |
| CH-401-18 | 18,0 cm, 7" |

TROELTSCH

| | |
|------------------|----------------------------|
| CH-403-12 | 12,0 cm, 4 $\frac{3}{4}$ " |
| CH-403-15 | 15,0 cm, 6" |
| CH-403-17 | 17,0 cm, 6 $\frac{3}{4}$ " |

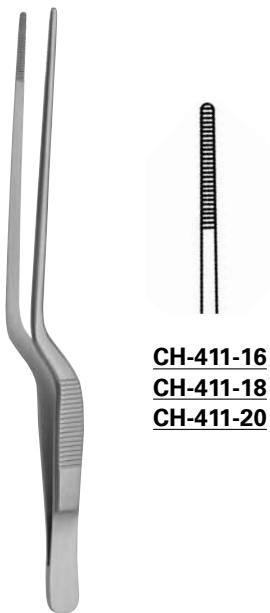

CH-411-16
CH-411-18
CH-411-20

JANSEN

| | |
|------------------|----------------------------|
| CH-411-16 | 16,0 cm, 6 $\frac{1}{4}$ " |
| CH-411-18 | 18,0 cm, 7" |
| CH-411-20 | 20,0 cm, 8" |

Suction Tubes

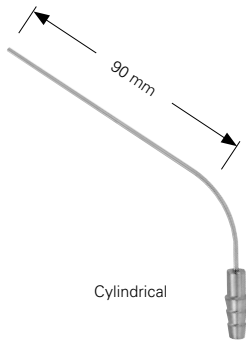

Cylindrical

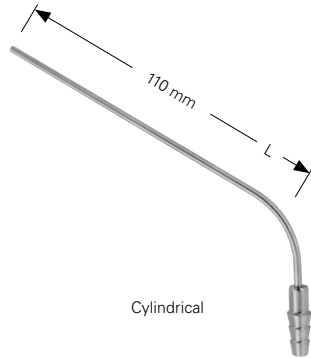

Cylindrical

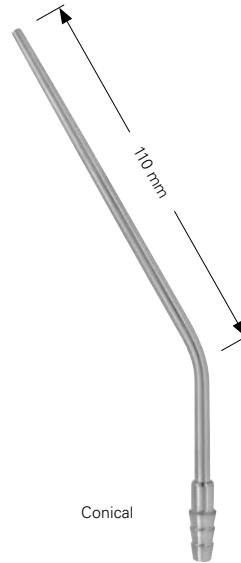

Conical

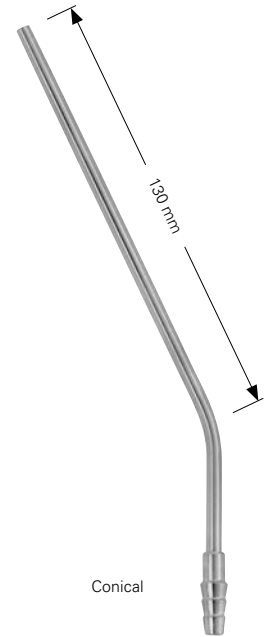

Conical

| | | | | | | | |
|------------------|----------|------------------|----------|------------------|----------|------------------|----------|
| CH-940-10 | Ø 1,0 mm | CH-940-25 | Ø 2,5 mm | CH-942-03 | Ø 3,0 mm | CH-942-05 | Ø 4,5 mm |
| CH-940-15 | Ø 1,5 mm | CH-941-30 | Ø 3,0 mm | CH-942-04 | Ø 3,5 mm | | |
| CH-940-20 | Ø 2,0 mm | CH-941-40 | Ø 4,0 mm | | | | |
| | | CH-941-50 | Ø 5,0 mm | | | | |

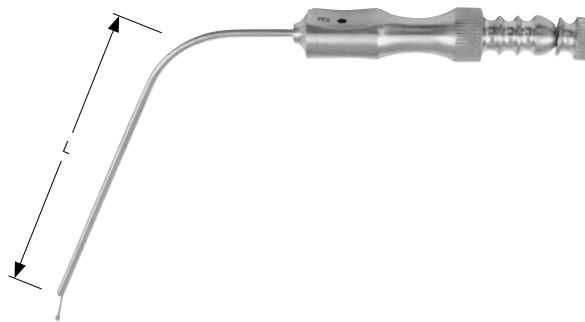

FERGUSSON

Length 110 mm Length 130 mm Length 160 mm Length 200 mm

Ø

| | | | | |
|-----------|------------------|------------------|------------------|------------------|
| 4 Charr. | CH-904-04 | | | |
| 5 Charr. | CH-904-05 | CH-904-25 | CH-904-45 | CH-904-65 |
| 6 Charr. | CH-904-06 | CH-904-26 | CH-904-46 | CH-904-66 |
| 7 Charr. | CH-904-07 | | | |
| 8 Charr. | CH-904-08 | CH-904-28 | CH-904-48 | CH-904-68 |
| 9 Charr. | CH-904-09 | CH-904-29 | CH-904-49 | CH-904-69 |
| 10 Charr. | CH-904-10 | | | |
| 11 Charr. | CH-904-11 | | | |
| 12 Charr. | CH-904-12 | CH-904-32 | CH-904-52 | CH-904-72 |
| 15 Charr. | CH-904-15 | CH-904-35 | CH-904-55 | CH-904-75 |

Retractors, Cotton Applicators



LANGE

CH-131-04 23,0 cm, 9"



Triangular serrated

FARRELL

- CH-630-12** Ø 0,9 x
- CH-630-14** Ø 0,9 x 14,0 cm
- CH-630-16** Ø 1,1 x 16,0 cm
- CH-630-18** Ø 1,2 x 18,0 cm



Spirally serrated

FARRELL

- CH-631-12** Ø 0,9 x
- CH-631-14** Ø 0,9 x 14,0 cm
- CH-631-16** Ø 1,1 x 16,0 cm
- CH-631-18** Ø 1,2 x 18,0 cm



Sharp

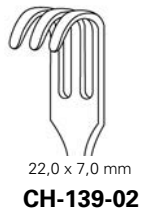

Blunt

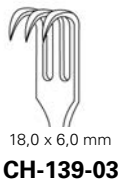

Sharp



SENN-MILLER

CH-139-01 - CH-139-03 16,0 cm, 6 ¼"

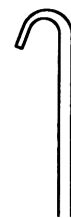

13,0 x 5,0 mm
CH-139-04



KILNER

CH-139-04 15,5 cm, 6"

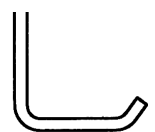

Bipolar Forceps with Irrigation



Straight

Width of tips

Length

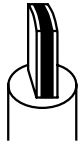

| | | |
|------------|--------|--------------------|
| 0,5 x 8 mm | 180 mm | CH-700-18 I |
| | 200 mm | CH-700-20 I |

| | | |
|------------|--------|--------------------|
| 1,0 x 8 mm | 180 mm | CH-710-18 I |
| | 200 mm | CH-710-20 I |

| | | |
|------------|--------|--------------------|
| 2,0 x 8 mm | 180 mm | CH-712-18 I |
| | 200 mm | CH-712-20 I |



Bayonet

Width of tips

Length

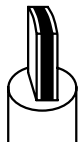

| | | |
|------------|--------|--------------------|
| 0,5 x 5 mm | 180 mm | CH-740-18 I |
| | 200 mm | CH-740-20 I |
| | 220 mm | CH-740-22 I |

| | | |
|------------|--------|--------------------|
| 1,0 x 5 mm | 180 mm | CH-750-18 I |
| | 200 mm | CH-750-20 I |
| | 220 mm | CH-750-22 I |

| | | |
|------------|--------|--------------------|
| 2,0 x 5 mm | 180 mm | CH-752-18 I |
| | 200 mm | CH-752-20 I |
| | 220 mm | CH-752-22 I |

Bipolar Forceps with Double Irrigation and Luer-Lock Connector



Width of tips

Length

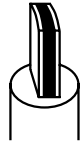

| | | |
|------------|--------|--------------------|
| 1,0 x 8 mm | 220 mm | CH-751-22 I |
| 1,5 x 8 mm | 220 mm | CH-753-22 I |



CH-751-90



Tubing set, sterile, single use



Order quantity: 40 pieces



Bipolar Forceps





Bipolar Forceps, straight, flat-plug, 500 Vp

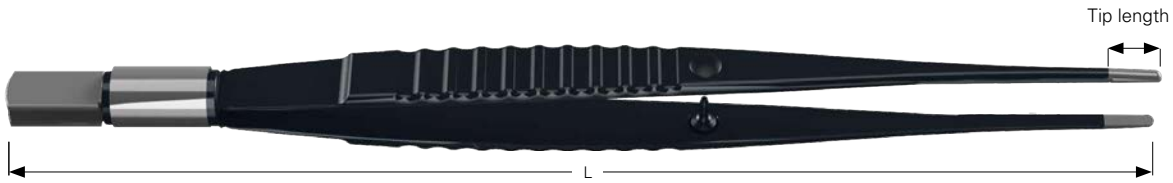

Order quantity: 1 piece







| Version | Tip | L = 165 mm | L = 180 mm | L = 195 mm | L = 225 mm |
|---|--------------|------------------|------------------|------------------|------------------|
|  Bipolar forceps, Needle | 6 mm 8 mm | CH-700-16 | CH-700-18 | CH-700-20 | CH-700-22 |
|  Bipolar forceps, Blunt, 1.0 mm | 6 mm 8 mm | CH-710-16 | CH-710-18 | CH-710-20 | CH-710-22 |
|  Bipolar forceps, Blunt, 2.0 mm | 6 mm 8 mm | CH-712-16 | CH-712-18 | CH-712-20 | CH-712-22 |

Bipolar Forceps, angled, flat-plug, 500 Vp

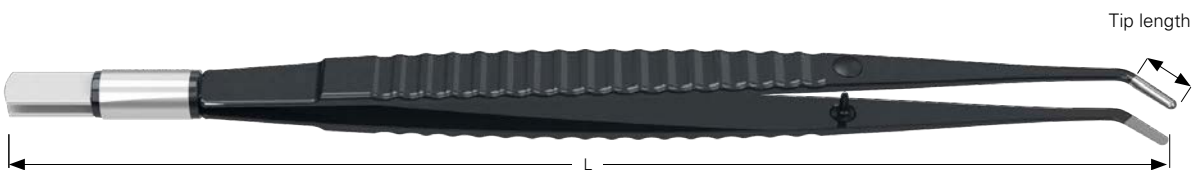

Order quantity: 1 piece



| Version | Tip | L = 165 mm | L = 180 mm | L = 190 mm | L = 225 mm |
|--|--------------|------------------|------------------|------------------|------------------|
|  Bipolar forceps, Needle | 6 mm 8 mm | CH-720-16 | CH-720-18 | CH-720-20 | CH-720-22 |
|  Bipolar forceps, Blunt, 1.0 mm | 6 mm 8 mm | CH-730-16 | CH-730-18 | CH-730-20 | CH-730-22 |
|  Bipolar forceps, Blunt, 2.0 mm | 6 mm 8 mm | | CH-732-18 | CH-732-20 | CH-732-22 |

! All bipolar forceps also with NON-STICK tip available

NON-STICK Silver tip

Bipolar Forceps





Bipolar Forceps, bayonet, flat-plug, 500 Vp



Bestelleinheit: 1 Stück
Order quantity: 1 piece



| Version | Tip | L = 165 mm | L = 180 mm | L = 195 mm | L = 220 mm | L = 240 mm |
|---|--------------|------------------|------------------|------------------|------------------|------------------|
|  Bipolar forceps, Needle | 6 mm 8 mm | CH-740-16 | CH-740-18 | CH-740-20 | CH-740-22 | |
|  Bipolar forceps, Blunt, 1.0 mm | 6 mm 8 mm | CH-750-16 | CH-750-18 | CH-750-20 | CH-750-22 | CH-750-24 |
|  Bipolar forceps, Blunt, 2.0 mm | 6 mm 8 mm | CH-752-16 | CH-752-18 | CH-752-20 | CH-752-22 | CH-752-24 |





Plug instrument side

Bipolar connecting cables



Flat plug, square

Flat plug, round

| | Plug unit side | Length | Item number | |
|---|-----------------------------|--------|------------------|------------------|
|  | VALLEYLAB USA / 2 banana | 3,0 m | CH-217-30 | CH-247-30 |
| | | 5,0 m | CH-217-50 | CH-247-50 |
| 28,2 mm  | AMNOTOM BOWA | 3,0 m | CH-215-30 | CH-245-30 |
| | VALLEYLAB EUROPE | 5,0 m | CH-215-50 | CH-245-50 |
| Ø 7,8 mm  | MARTIN I BERCHTOLD | 3,0 m | CH-213-30 | CH-243-30 |
| | | 5,0 m | CH-213-50 | CH-243-50 |
| Ø 12,3 mm  | ERBE STORZ WISAP | 3,0 m | CH-211-30 | CH-241-30 |
| | | 5,0 m | CH-211-50 | CH-241-50 |

Bipolar Micro-Coagulation Forceps

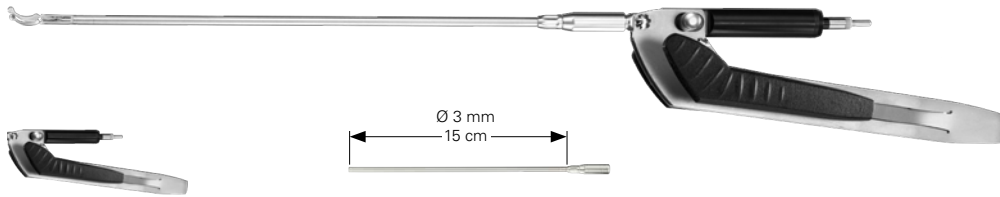

CH-100-00

Handle, bayonet

CH-100-02

Shaft, bayonet

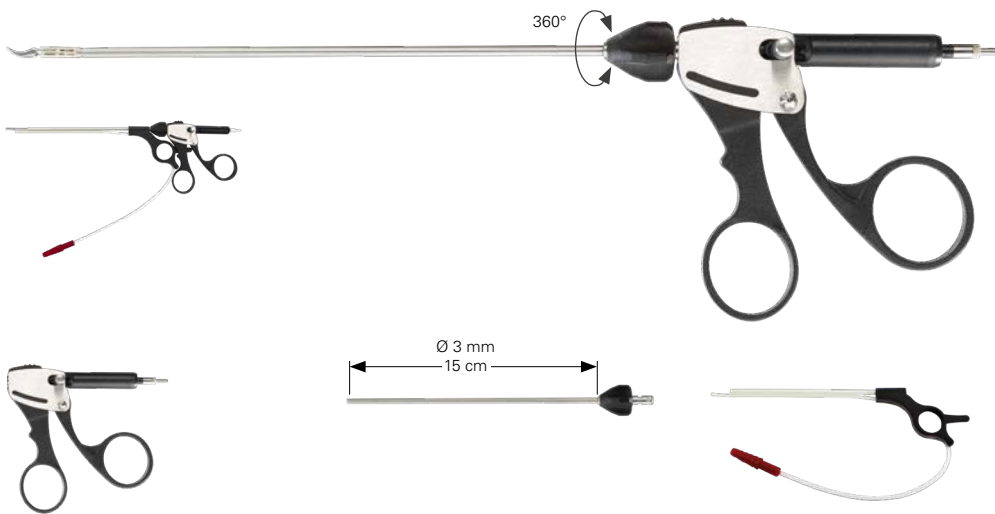

CH-100-10

Ring handle

CH-100-12

Shaft, Ring handle







CH-100-90

Suction probe

| | Plug unit side | Length | Round plug |
|--|-------------------------------------|--------|------------------|
| | SKILL BOWA VALLEYLAB EUROPE | 3,0 m | CH-205-30 |
| | | 5,0 m | CH-205-50 |
| | MARTIN I BERCHTOLD | 3,0 m | CH-201-30 |
| | | 5,0 m | CH-201-50 |
| | ERBE STORZ WISAP | 3,0 m | CH-201-30 |
| | | 5,0 m | CH-201-50 |

Electrodes for Bipolar Micro-Coagulation Forceps

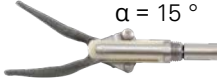

| | | Insert, only | Complete, bayonet handle | Complete, ring handle |
|---|--------------------------------|------------------|--------------------------|-----------------------|
|  | Scissors, curved | CH-120-03 | CH-120-03 C | CH-120-03 CS |
|  | Grasping forceps, fenestrated | CH-102-03 | CH-102-03 C | CH-102-03 CS |
|  | Spoon forceps Ø 2 mm, curved | CH-104-03 | CH-104-03 C | CH-104-03 CS |
|  | Spoon forceps Ø 2.7 mm, curved | CH-106-03 | CH-106-03 C | CH-106-03 CS |
|  | Dissector Maryland, curved | CH-108-03 | CH-108-03 C | CH-108-03 CS |
|  | Dissector, angled | CH-110-03 | CH-110-03 C | CH-110-03 CS |

| | | | Complete, bayonet handle | Ringgriff |
|---|------------------------|----------------------------------|--|---|
|  | | Insert, only | | |
|  | Flamingo jaw, vertical | Ø 0,7 mm Ø 1,2 mm Ø 2,0 mm | CH-112-07 C CH-112-12 C CH-112-20 C | CH-112-07 CS CH-112-12 CS CH-112-20 CS |
|  | Flamingo jaw, vertical | Ø 0,7 mm Ø 1,2 mm Ø 2,0 mm | CH-114-07 C CH-114-12 C CH-114-20 C | CH-114-07 CS CH-114-12 CS CH-114-20 CS |
|  | Flamingo jaw, vertical | Ø 0,7 mm Ø 1,2 mm Ø 2,0 mm | CH-116-07 C CH-116-12 C CH-116-20 C | CH-116-07 CS CH-116-12 CS CH-116-20 CS |

Bipolar Stitch Coagulation Electrodes

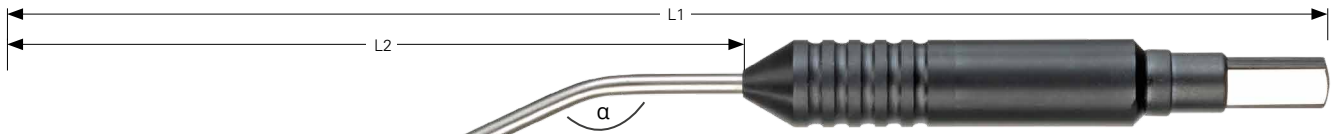

| Angle α | Length 1 | Length 2 | Item number |
|----------------|----------|----------|------------------|
| 20 ° | 190 mm | 105 mm | CH-670-00 |



| | | | |
|------|--------|--------|------------------|
| 30 ° | 195 mm | 110 mm | CH-670-02 |
|------|--------|--------|------------------|



| | | | |
|------|--------|--------|------------------|
| 55 ° | 195 mm | 112 mm | CH-670-04 |
|------|--------|--------|------------------|



| | | | |
|------|--------|-------|------------------|
| 60 ° | 175 mm | 90 mm | CH-670-06 |
|------|--------|-------|------------------|

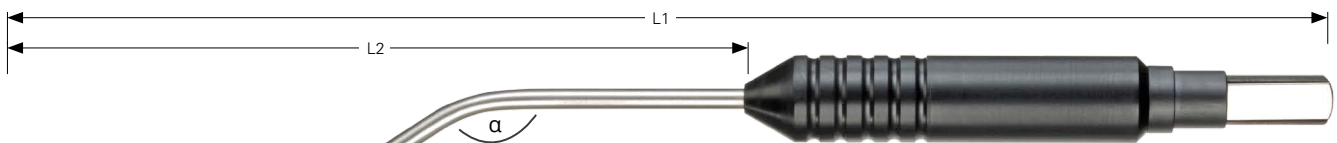

| Angle α | Length 1 | Length 2 | Item number |
|----------------|----------|----------|------------------|
| 30 ° | 190 mm | 105 mm | CH-670-10 |

Bipolar Probe Electrodes

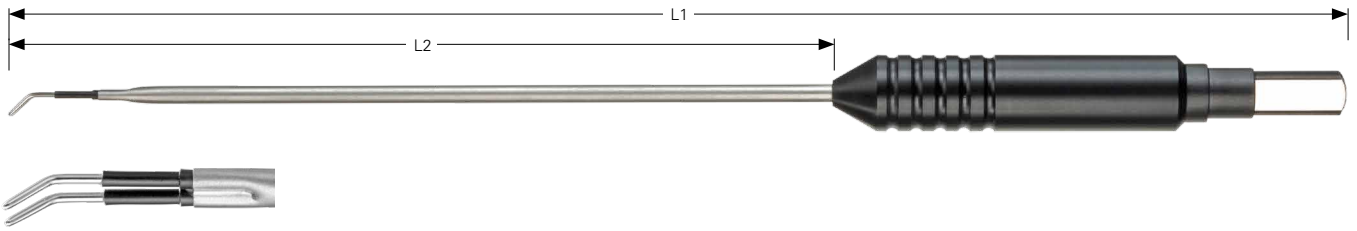

Tip 45° curved



| Angle α | Length 1 | Length 2 | Item number |
|----------------|----------|----------|------------------|
| 0° | 215 mm | 130 mm | CH-670-30 |

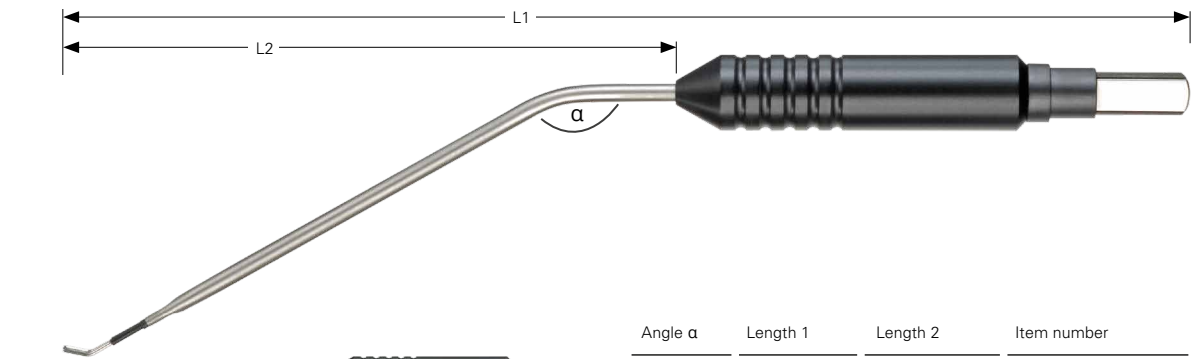

| Angle α | Length 1 | Length 2 | Item number |
|----------------|----------|----------|------------------|
| 30° | 185 mm | 100 mm | CH-670-32 |



| Angle α | Length 1 | Length 2 | Item number |
|----------------|----------|----------|------------------|
| 45° | 185 mm | 100 mm | CH-670-34 |



| Angle α | Length 1 | Length 2 | Item number |
|----------------|----------|----------|------------------|
| 90° | 185 mm | 100 mm | CH-670-36 |



Tampon and Polypus Forceps

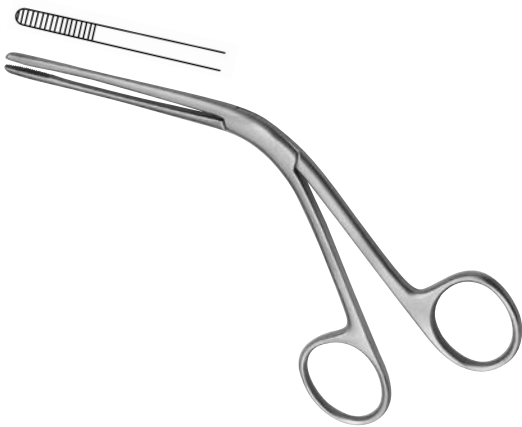

TILLEY

CH-601-13 14,0 cm, 5 1/2"

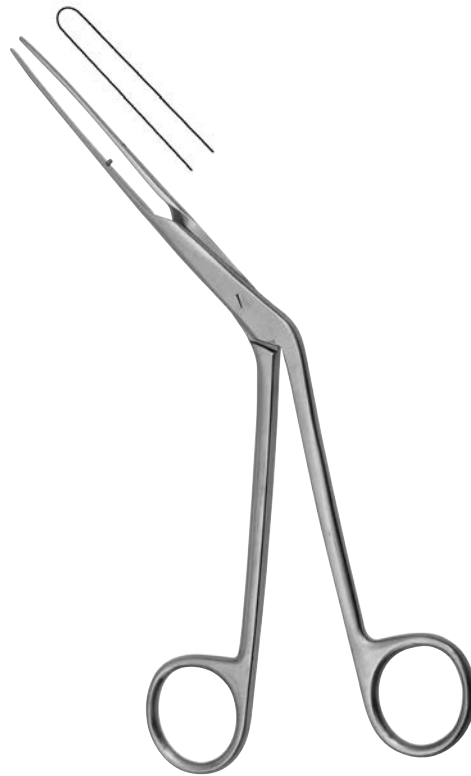

LUBET-BARBON

CH-603-20 20,0 cm, 8"



WESTMACOTT

CH-604-20 20,0 cm, 8"



HARTMANN

CH-607-16 16,0 cm, 6 1/4"



HARTMANN

CH-607-20 20,0 cm, 8"

Tampon and Polypus Forceps

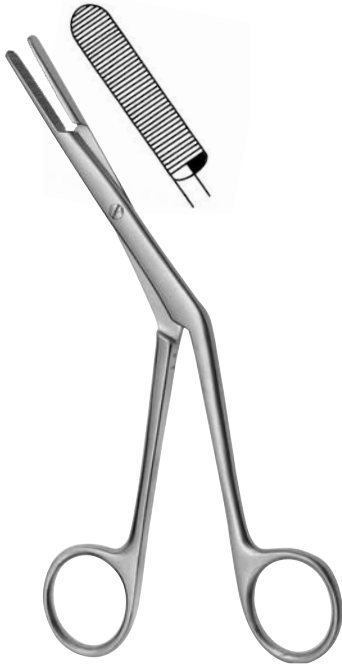

KILLIAN

CH-609-17 17,0 cm, 6 ³/₄ "



HEYMANN-KNIGHT

CH-609-18 18,0 cm, 7 "



LITTAUER

CH-611-18 18,0 cm, 7 "



HARTMANN

CH-615-19 19,0 cm, 7 ¹/₂ "

Powder Blowers



CH-036-13 130 mm



CH-036-11 110 mm



CH-036-08 80 mm

KABERSKE

CH-036-00 SET

Complete, consisting of:

| | |
|-----------------------|------------------|
| 1 Valve rubber Bulb | CH-036-50 |
| 1 Bottle | CH-036-01 |
| 1 Ear cannula, 80 mm | CH-036-08 |
| 1 Ear cannula, 110 mm | CH-036-11 |
| 1 Ear cannula, 130 mm | CH-036-13 |
| 1 Atomizer | CH-036-40 |

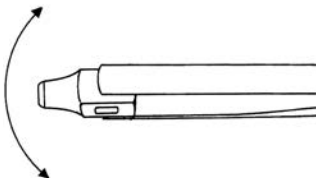

UNIVERSAL

CH-039-00

for Rhinology

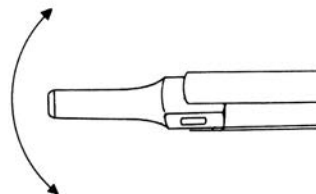

UNIVERSAL

CH-040-00

for Otology

Polypus Snares

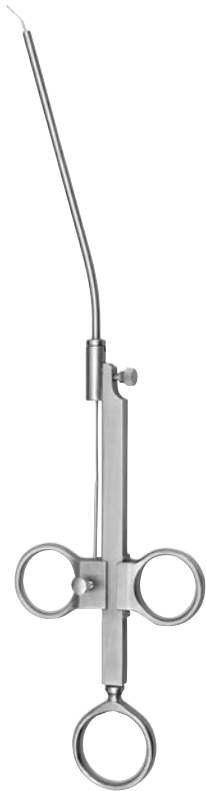

KRAUSE

CH-621-26 26,0 cm, 10 1/4"



KRAUSE-VOSS

CH-623-26 26,0 cm, 10 1/4"



LANGE-WILDE

CH-624-24 24,0 cm, 9 1/2"



Packing unit: 12 pieces

Snare wires



Packing unit: 100 pieces

Snare wires

Snare wires, coil of 10 m



CH-627-30 Ø 0,3 mm
CH-627-40 Ø 0,4 mm



CH-627-93 Ø 0,3 mm
CH-627-94 Ø 0,4 mm



CH-158-02 Ø 0,2 mm
CH-158-03 Ø 0,3 mm
CH-158-04 Ø 0,4 mm

Nasal Scissors



Ø 5,0 mm | 13,0 cm | 5 1/8"



With tubular shaft and Luer-Lock rinsing channel

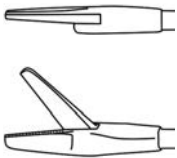

CH-600-00 LL

Straight

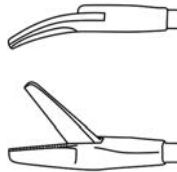

CH-600-01 LL

Curved left

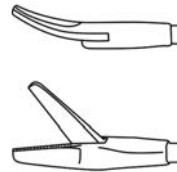

CH-600-02 LL

Curved right

11,0 cm | 4 3/8"



CH-600-10

Straight



CH-600-11

Curved left

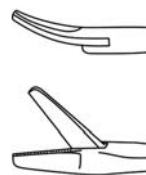

CH-600-12

Curved right

Nasal Scissors

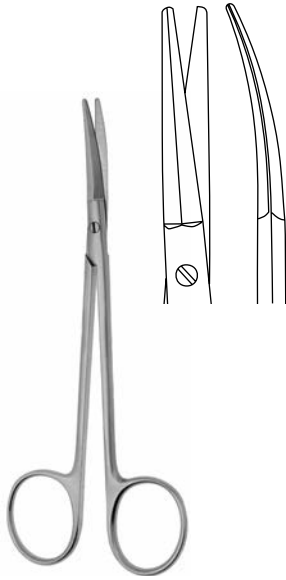

FOMON
CH-319-13 13,0 cm, 5 1/8"



FOMON
CH-321-13 13,0 cm, 5 1/8"

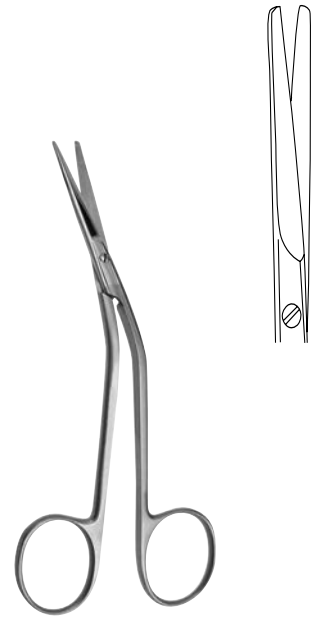

FOMON-FINO
CH-327-13 13,0 cm, 5 1/8"

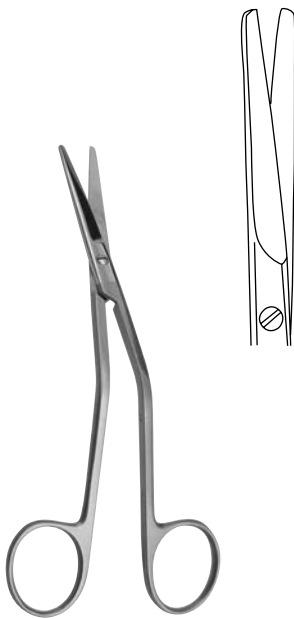

FOMON
CH-327-14 13,0 cm, 5 1/8"

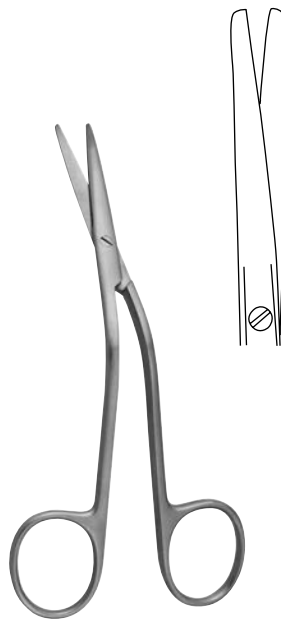

FOMON
CH-329-13 13,0 cm, 5 1/8"

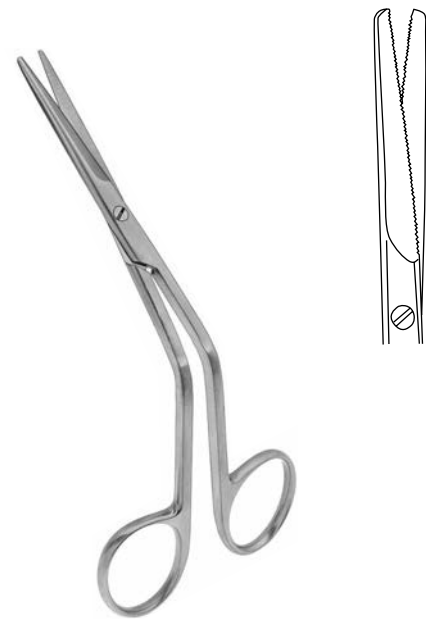

FOMON
CH-329-15 15,0 cm, 6"

Nasal Scissors

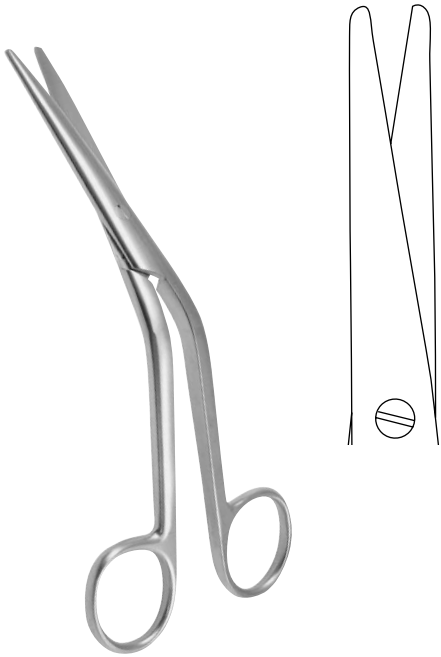

COTTLE

CH-331-16 16,0 cm, 6 ¼"



HEYMANN

CH-333-17 17,0 cm, 6 ¾"
CH-335-18 18,0 cm, 7"
CH-333-20 20,0 cm, 8"

CH-333-17
CH-335-18
CH-333-20

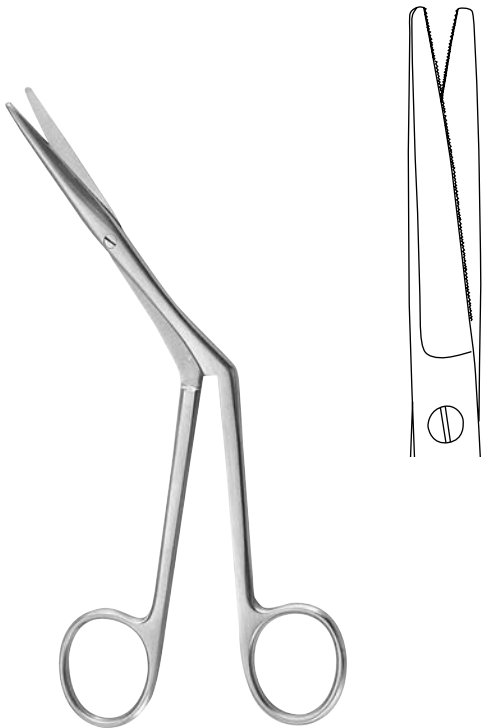

HEYMANN

11-337-18 18,0 cm, 7"

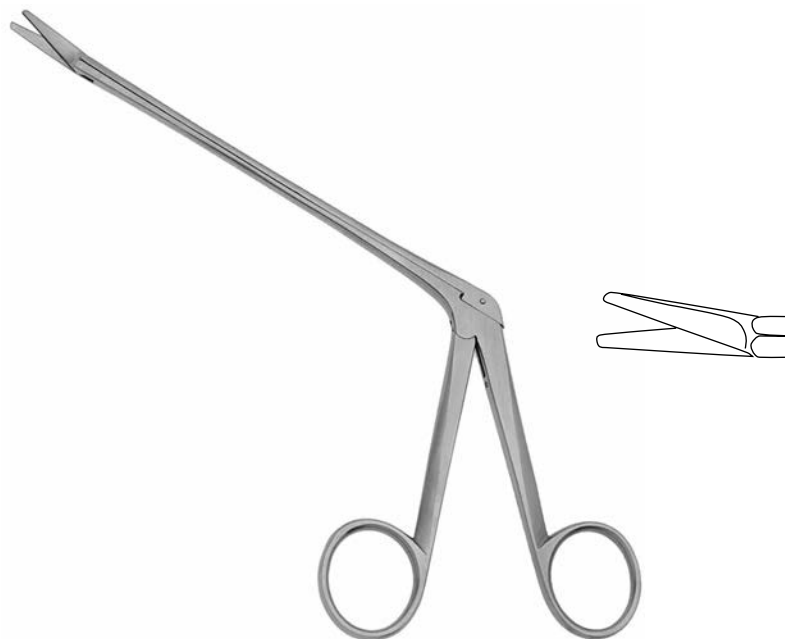

OLIVECRONA

11-338-23 23,0 cm, 9"

Nasal Scissors

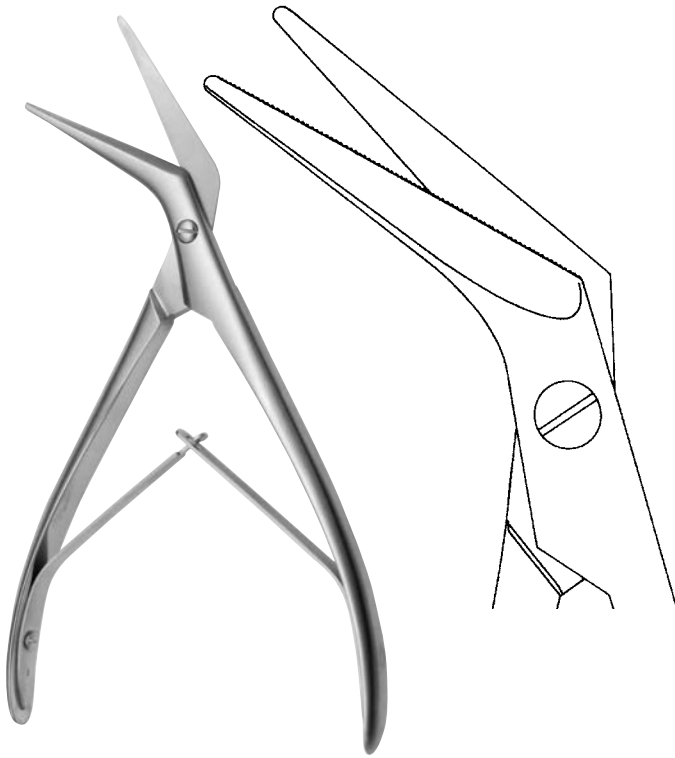

TESSIER

CH-339-20 20,0 cm, 8"

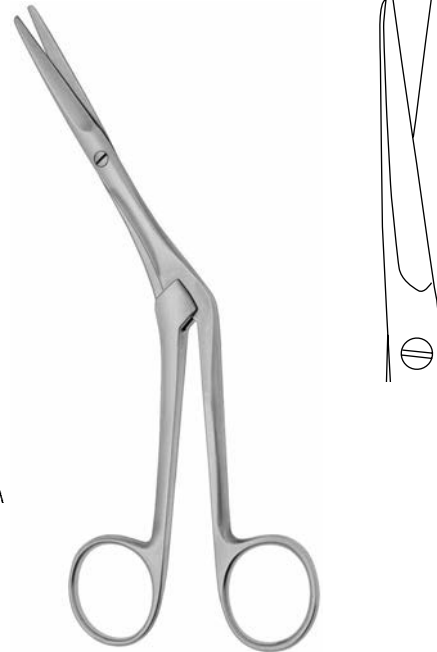

KNIGHT

CH-341-18 18,0 cm, 7"

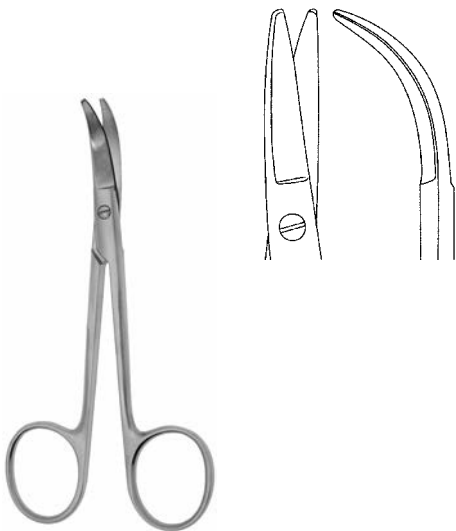

FOMON

CH-343-11 11,5 cm, 4 1/2"

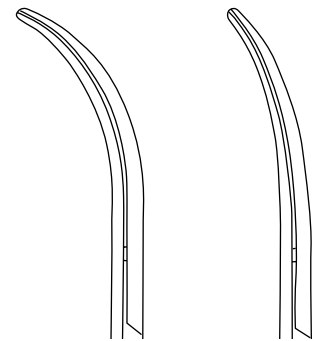

CH-345-11

CH-345-12



LANDOLT

CH-345-11 - CH-345-12 12,0 cm, 4 3/4"

Biopsy- & Grasping Forceps

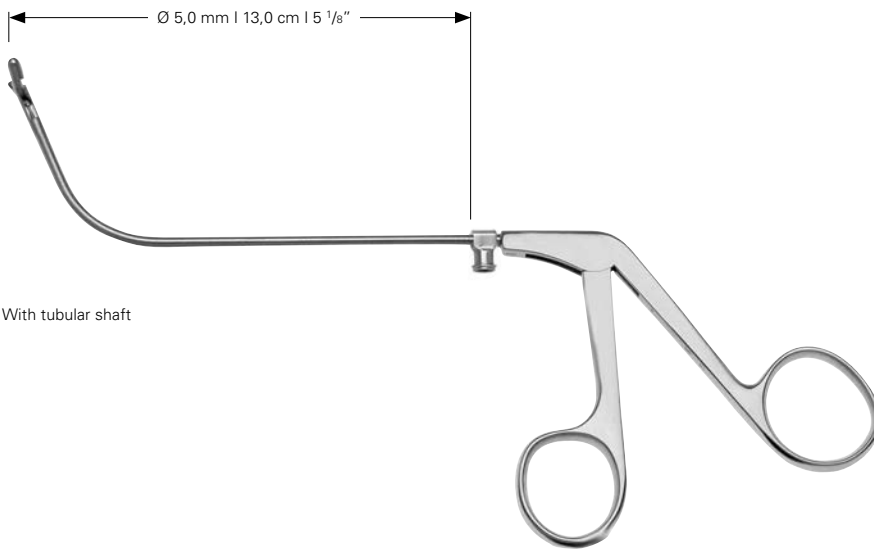

With tubular shaft



CH-610-03 LL 3,0 mm
CH-610-04 LL 4,0 mm

70° curved upwards, vertical opening



CH-611-03 LL 3,0 mm
CH-611-04 LL 4,0 mm

70° curved upwards, horizontal opening

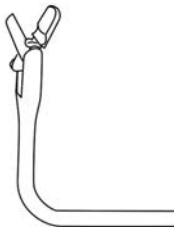

CH-612-03 LL 3,0 mm
CH-612-04 LL 4,0 mm

90° curved upwards, vertical opening

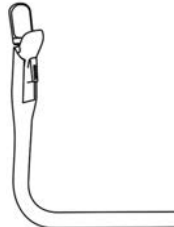

CH-613-03 LL 3,0 mm
CH-613-04 LL 4,0 mm

90° curved upwards, horizontal opening

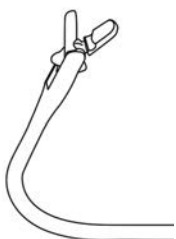

CH-614-03 LL 3,0 mm
CH-614-04 LL 4,0 mm

110° curved upwards, vertical opening



CH-615-03 LL 3,0 mm
CH-615-04 LL 4,0 mm

110° curved upwards, horizontal opening

Nasal Scissors

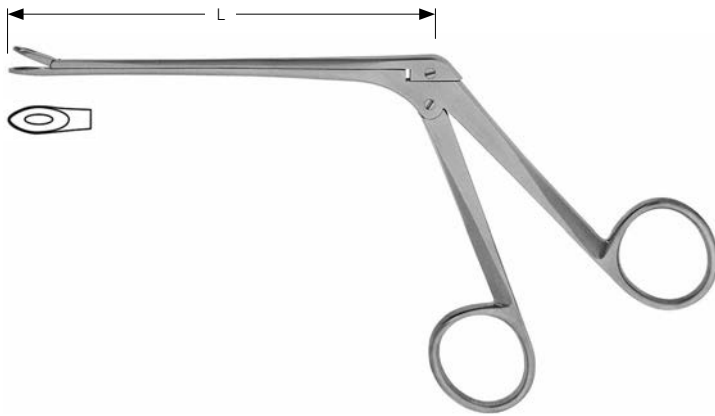

WEIL-BLAKESLEY

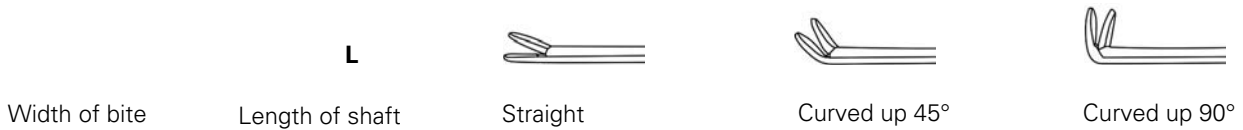

| Width of bite | Length of shaft | Straight | Curved up 45° | Curved up 90° |
|---------------|-----------------|------------------|------------------|------------------|
| 3,0 mm | 120 mm, 4 3/4" | CH-036-30 | CH-037-30 | CH-038-30 |
| 3,6 mm | 120 mm, 4 3/4" | CH-036-36 | CH-037-36 | CH-038-36 |
| 4,2 mm | 120 mm, 4 3/4" | CH-036-42 | CH-037-42 | CH-038-42 |
| 4,8 mm | 120 mm, 4 3/4" | CH-036-48 | CH-037-48 | CH-038-48 |
| 5,2 mm | 120 mm, 4 3/4" | CH-036-58 | CH-037-58 | CH-038-58 |

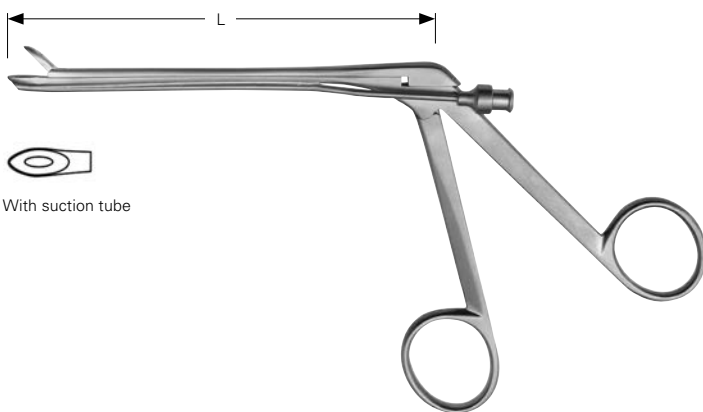

WEIL-BLAKESLEY

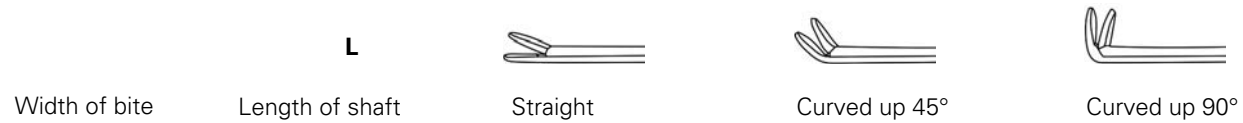

| Width of bite | Length of shaft | Straight | Curved up 45° | Curved up 90° |
|---------------|-----------------|--------------------|--------------------|--------------------|
| 2,5 mm | 120 mm, 4 3/4" | CH-036-30 A | CH-037-30 A | |
| 3,6 mm | 120 mm, 4 3/4" | CH-036-36 A | CH-037-36 A | CH-038-36 A |
| 4,8 mm | 120 mm, 4 3/4" | CH-036-48 A | CH-037-48 A | |

Nasal Scissors

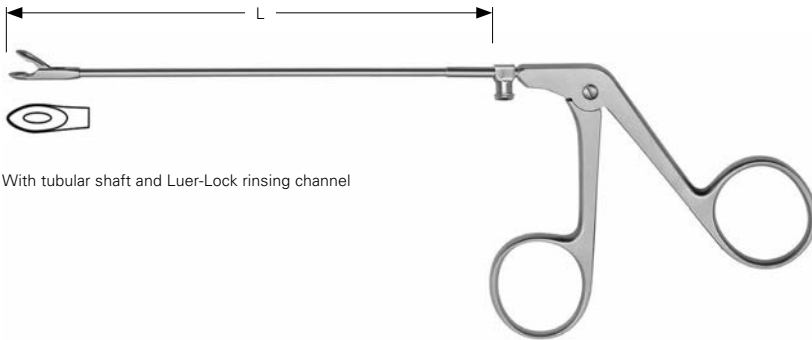

With tubular shaft and Luer-Lock rinsing channel

WEIL-BLAKESLEY

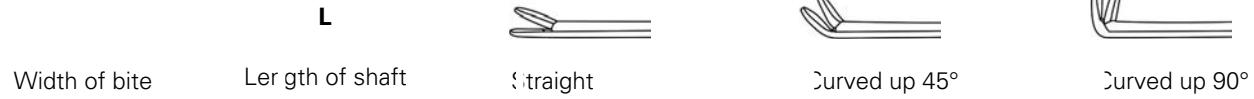

| | | | | |
|--------|------------|---------------------|---------------------|---------------------|
| 3,0 mm | 130 mm, 5" | CH 036-30 LL | CH 037-30 LL | |
| 3,6 mm | 130 mm, 5" | CH 036-36 LL | CH 037-36 LL | CH 038-36 LL |
| 4,2 mm | 130 mm, 5" | CH 036-42 LL | CH 037-42 LL | CH 038-42 LL |
| 4,8 mm | 130 mm, 5" | CH 036-48 LL | CH 037-48 LL | CH 038-48 LL |

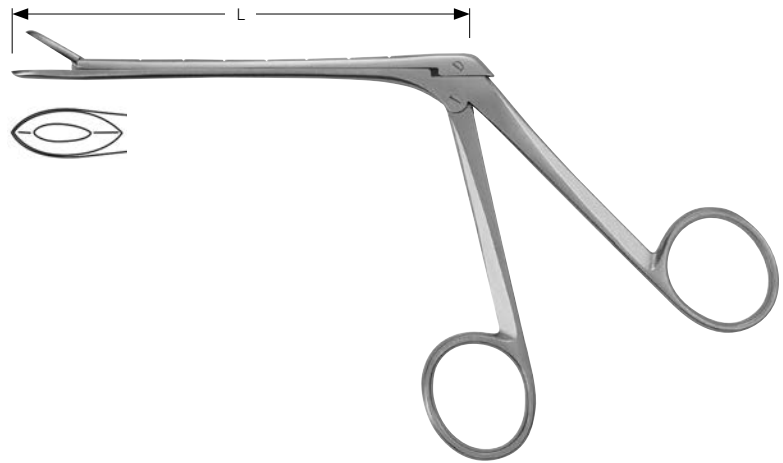
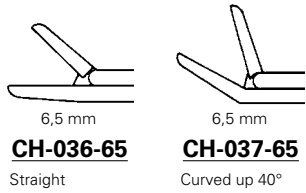

TILLEY-HENCKEL

CH-036-65 - CH-037-65 10,0 cm, 4"



Nasal Scissors

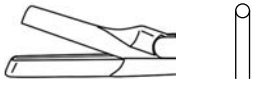

- CH-038-00** 1,0 mm

- CH-038-01** 1,5 mm

Straight, through cutting

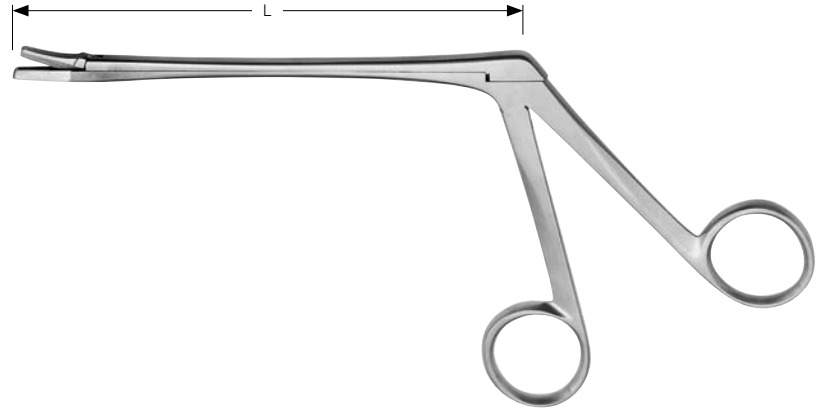

STRUYKEN

- CH-038-00 - CH-038-01** 12,0 cm, 4 3/4 "

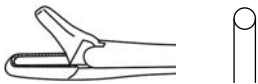

- CH-038-02** 2,0 mm

- CH-038-03** 3,0 mm

- CH-038-04** 4,0 mm

Straight, through cutting

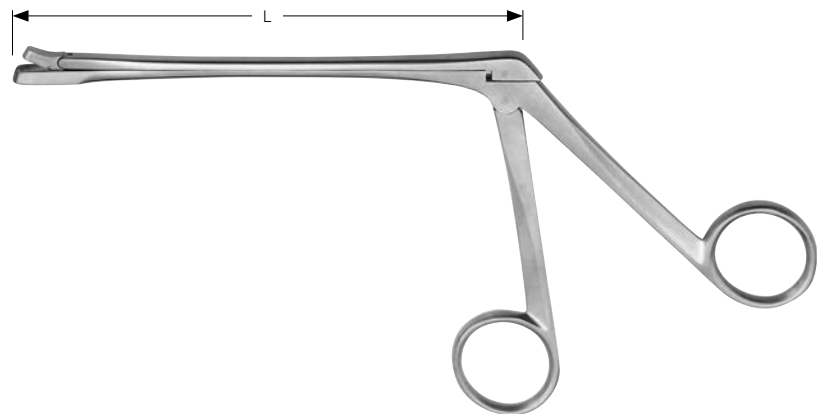

MYLES

- CH-038-02 - CH-038-04** 12,0 cm, 4 3/4 "



- CH-038-11** 3,0 mm

Curved up 60°, through cutting

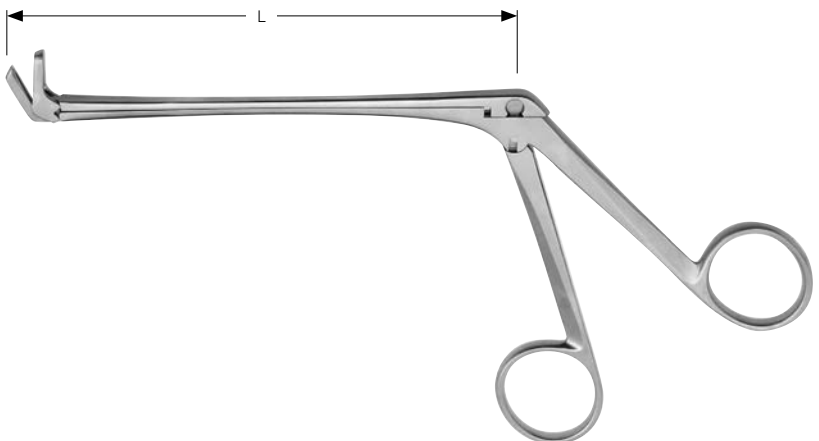

FRY

- CH-038-11** 11,5 cm, 4 1/2 "

Nasal Scissors



CH-038-12 2,5 mm
CH-038-13 3,0 mm

Straight, through cutting

GRUENWALD-HENKE

CH-038-12 - CH-038-13 11,0 cm, 4 3/8"

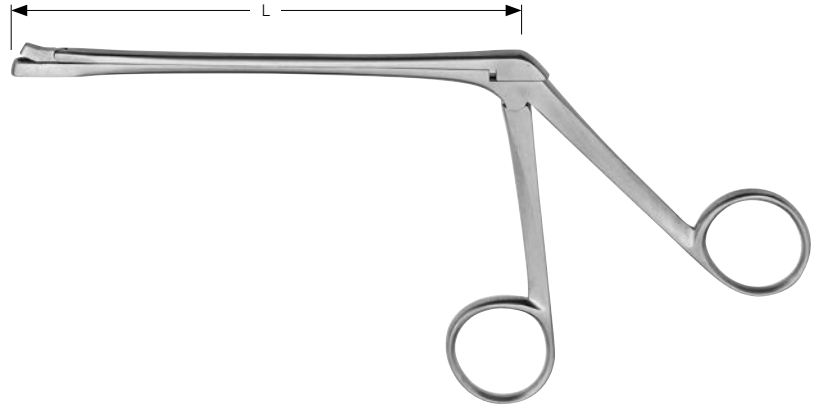

CH-038-60 6,0 x 14,0 mm
 Curved up 60°

BLAKESLEY-WIGAND

CH-038-60 11,0 cm, 4 3/8"

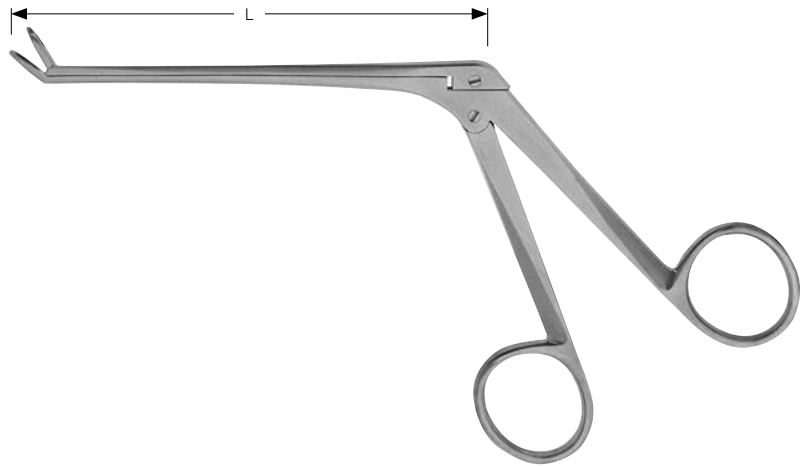

CH-039-25 2,5 mm
 Curved up 45°

HAJEK

CH-039-25 12,0 cm, 4 3/4"

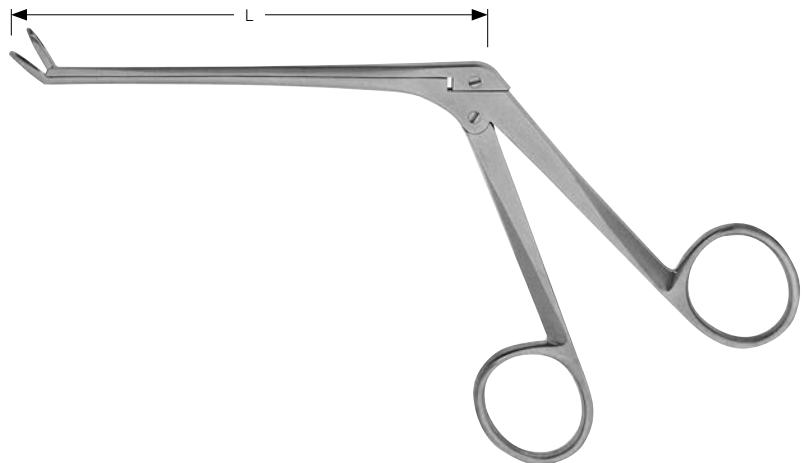

Nasal Scissors



| | |
|------------------|---------|
| CH-040-05 | 5,0 mm |
| CH-040-07 | 7,0 mm |
| CH-040-09 | 9,0 mm |
| CH-040-11 | 11,0 mm |

Straight, through cutting

HARTMANN

CH-040-05 - CH-040-11 12,0 cm, 4 ¾"

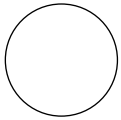

| | |
|------------------|---------|
| CH-040-13 | 13,0 mm |
| CH-040-15 | 15,0 mm |
| CH-040-17 | 17,0 mm |

Straight, through cutting

HARTMANN

CH-040-13 - CH-040-17 12,0 cm, 4 ¾"

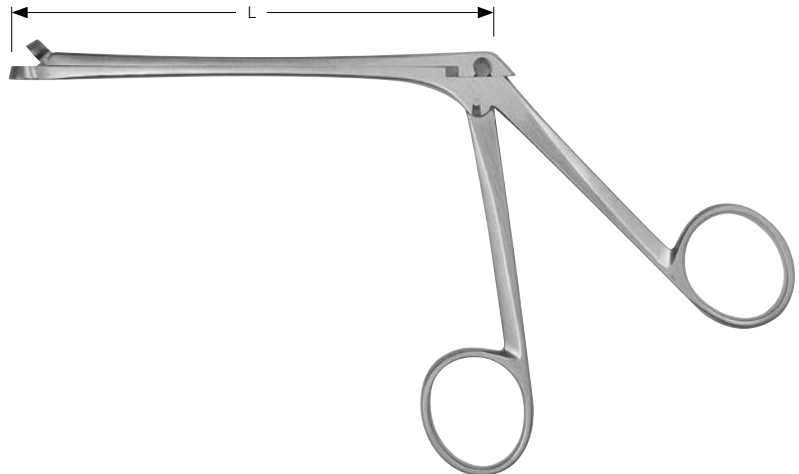

| | |
|------------------|---------|
| CH-041-11 | 11,0 mm |
| CH-041-12 | 12,0 mm |
| CH-041-13 | 13,0 mm |

Straight, through cutting

SCHMEDEN

CH-041-11 - CH-041-13 12,0 cm, 4 ¾"

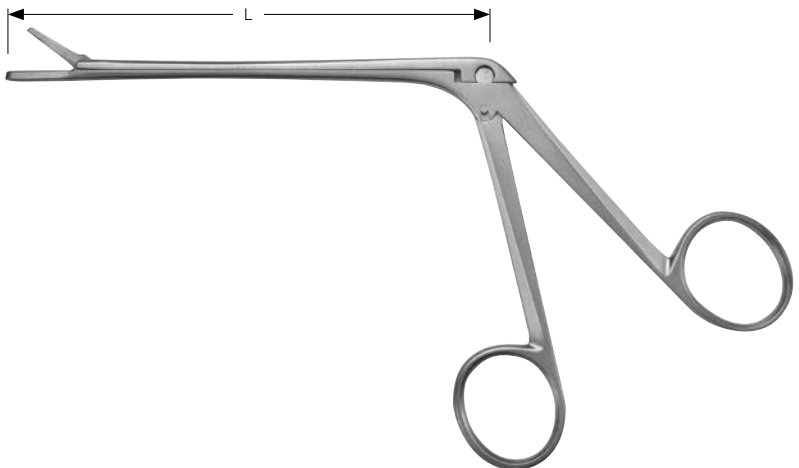

Nasal Forceps, Nasal Cutting Forceps



Ø 7,0 mm

CH-042-01

Straight



CH-042-02

Straight



CH-042-03

Straight

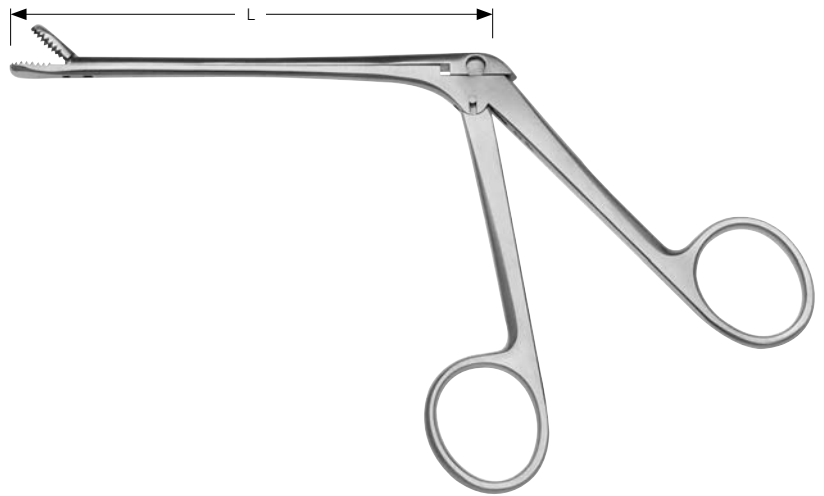

WATSON-WILLIAMS

CH-042-01 - CH-042-03 12,0 cm, 4 3/4"



CH-042-04 5,0 mm

CH-042-05 7,0 mm

CH-042-06 9,0 mm

Straight

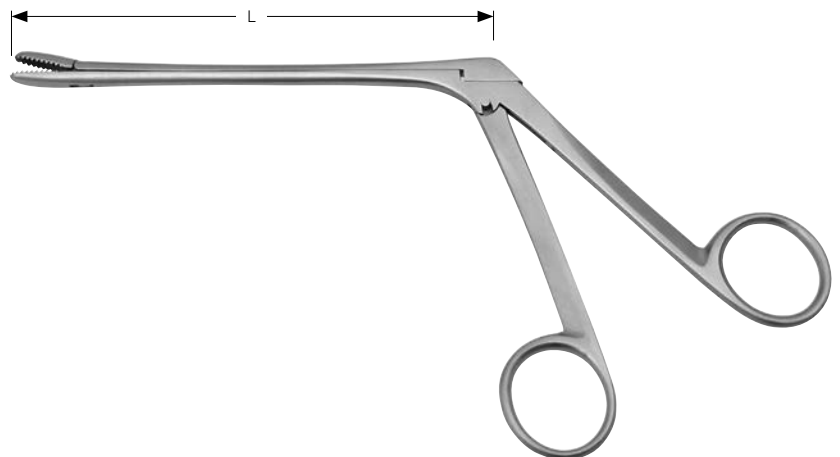

WATSON-WILLIAMS

CH-042-04 - CH-042-06 12,0 cm, 4 3/4"



3,5 mm

CH-042-11

Curved up 45°, through cutting



3,5 mm

CH-042-12



WATSON-WILLIAMS

CH-042-11 - CH-042-12 12,0 cm, 4 3/4"

Rongeurs



CH-043-01

Curved up 45°

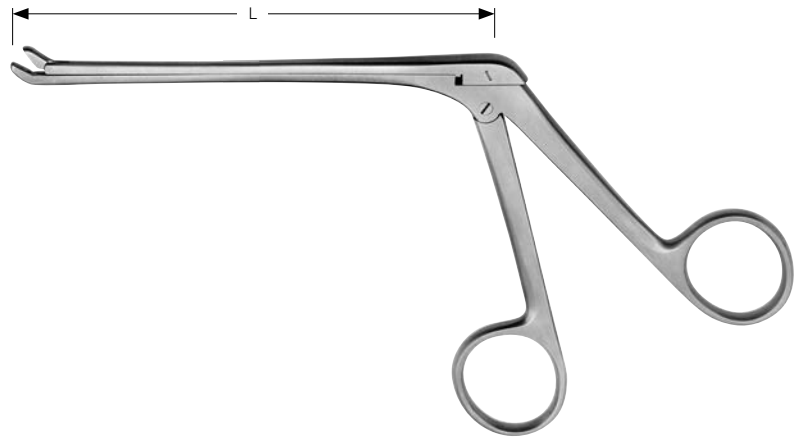

WATSON-WILLIAMS

CH-043-01 12,0 cm, 4 3/4"



3,0 mm

CH-044-03

Straight



5,0 mm

CH-044-05

Straight



3,0 mm

CH-045-03

Curved up 45°

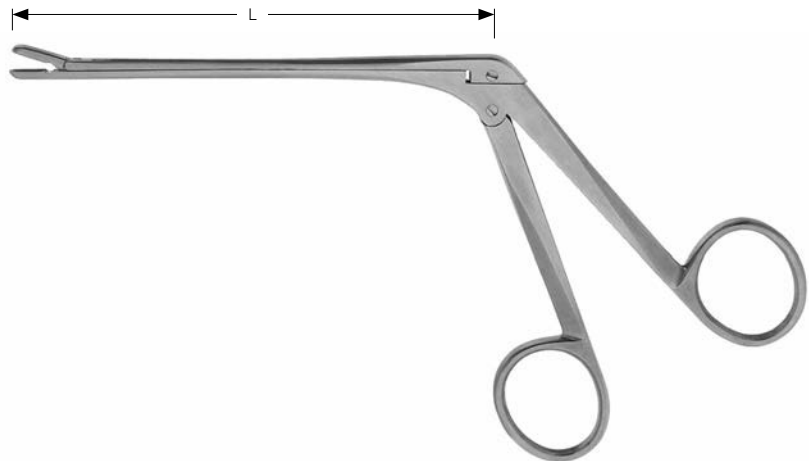

TAKAHASHI

CH-044-03 - CH-045-03 12,0 cm, 4 3/4"



2,0 mm

CH-046-00

Straight

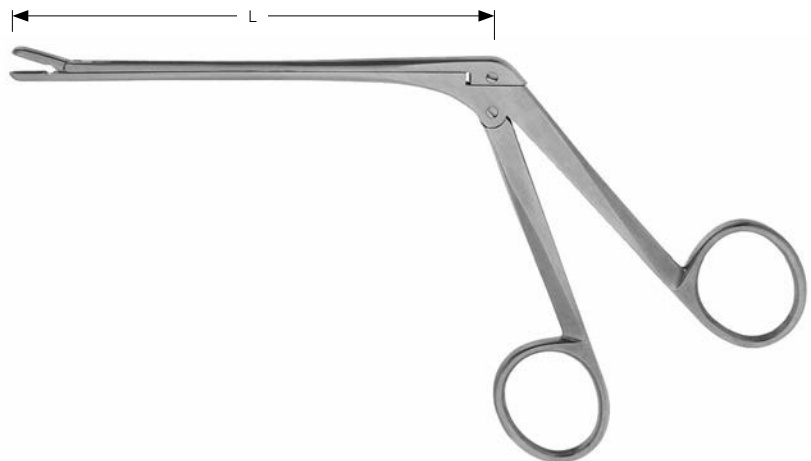

BECK

CH-046-00 13,0 cm, 5 1/2"

Septum Forceps, Vomer Forceps



CH-801-01



CH-801-02



CRAIG

CH-801-01 - CH-801-02 16,5 cm, 6 1/2"



CH-803-01



CH-803-02



CRAIG

CH-803-01 - CH-803-02 16,5 cm, 6 1/2"



Fig. 1

CH-804-01



Fig. 2

CH-804-02



Fig. 3

CH-804-03



HEYMANN

CH-804-01 - CH-804-03 18,0 cm, 7"



CH-806-19

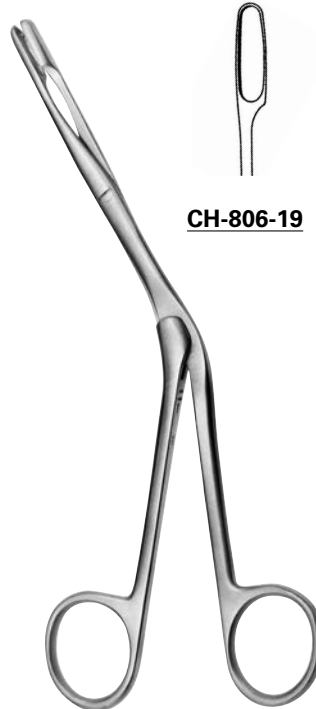

KNIGHT

CH-806-19 18,0 cm, 7"

Septum Forceps, Vomer Forceps

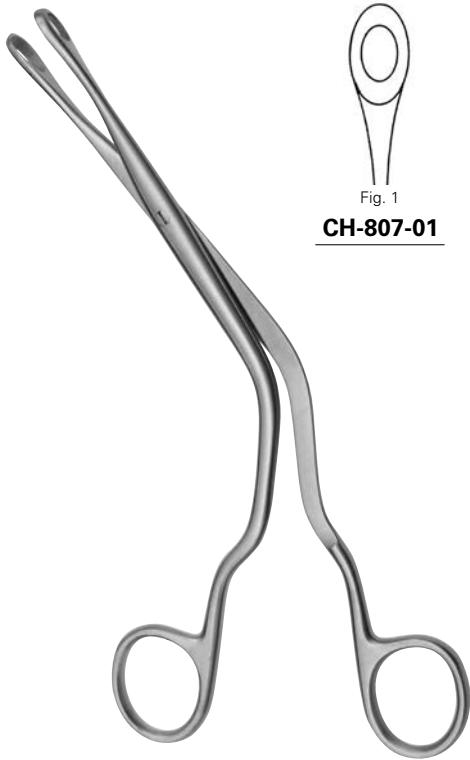

Fig. 1

CH-807-01



Fig. 2

CH-807-02

LUC

CH-807-01 - CH-807-02 20,0 cm, 8"

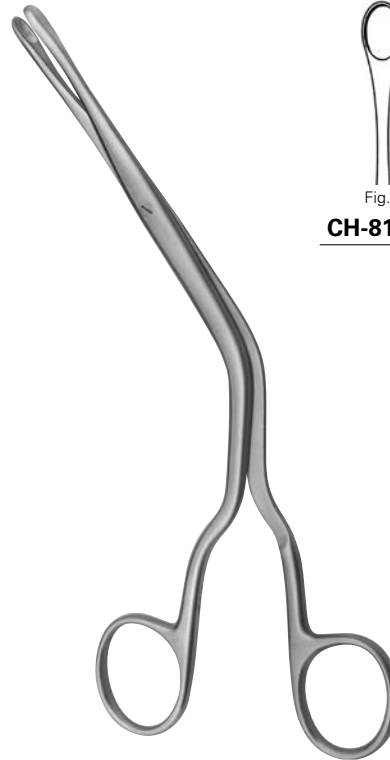

Fig. 1

CH-811-01



Fig. 2

CH-811-02

LUC

CH-811-01 - CH-811-02 20,0 cm, 8"

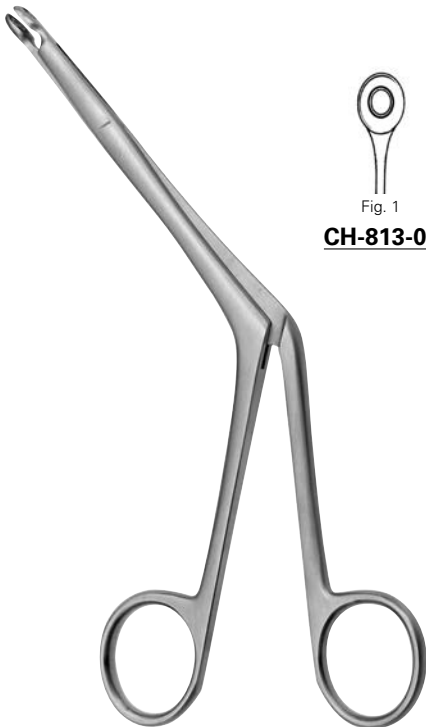

Fig. 1

CH-813-01



Fig. 2

CH-813-02



Fig. 3

CH-813-03



Fig. 4

CH-813-04

BRUENINGS

CH-813-01 - CH-813-04 19,0 cm, 7 1/2"

Septum Forceps



ASH

CH-825-22 23,0 cm, 9"



COTTLE-WALSHAM

CH-826-01 - CH-826-03 23,0 cm, 9"



Fig. 1

CH-826-01

Straight



Fig. 2

CH-826-02

Left



Fig. 3

CH-826-03

Right



Septum Forceps



Dismantable

COTTLE-WALSHAM

CH-828-22 22,0 cm, 8 3/4"



KRESSNER

CH-828-03 22,0 cm, 8 3/4"



3,0 mm

CH-829-03



4,0 mm

CH-830-01

Spoon shaped jaws

MIDDLETON-JANSEN

CH-830-01 20,0 cm, 8"



3,4 mm

CH-830-02

Through cutting

MIDDLETON-JANSEN

CH-830-02 19,0 cm, 7 1/2"

Septum Forceps, Gelfoam Forceps



CH-845-21



CH-845-99

RUBIN

CH-845-21 21,0 cm, 8 ¼"



CH-848-20

CH-848-20 20,0 cm, 8"



11 x 14 mm

CH-846-11



22 x 30 mm

CH-846-22

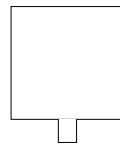

30 x 30 mm

CH-846-30

GELFOAM

CH-846-11 - CH-846-30 18,0 cm, 7"

Septum Scissors

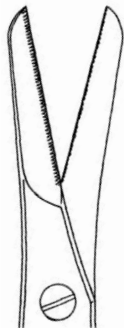

Serrated

CAPLAN

CH-841-20 20,0 cm, 8"

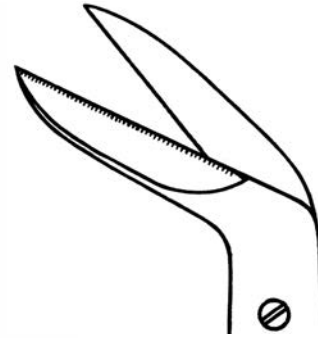

Serrated

KILLIAN

CH-843-21 20,0 cm, 8"



CH-704-19

COTTLE-KAZANJIAN

CH-704-19 19,0 cm, 7 ¼"

Swivel Knives, Elevators

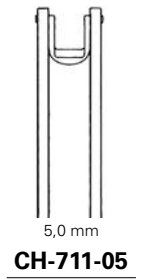
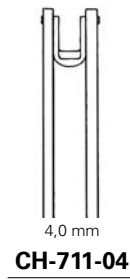
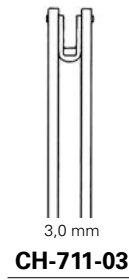
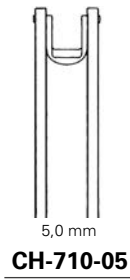
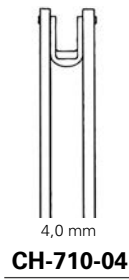
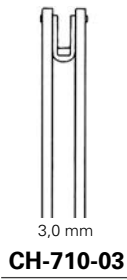

BALLENGER

CH-710-03 - CH-710-05 21,0 cm, 8 ¼ "

BALLENGER

CH-711-03 - CH-711-05 20,0 cm, 8 "

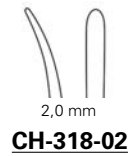
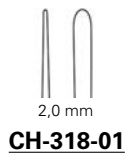

Elevator

LEMPERT

CH-318-01 - CH-318-03 16,5 cm, 6 ½ "

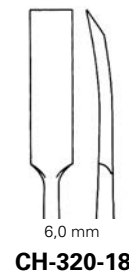

Elevator

LEMPERT

CH-320-18 18,0 cm, 7 "

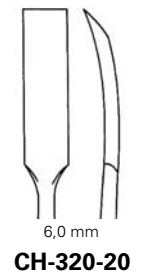

Elevator

LEMPERT

CH-320-20 20,5 cm, 8 "

Septum Elevators



3,3 mm
CH-655-18

HALLE

CH-655-18 18,0 cm, 7"



Ø 4,0 mm
CH-660-21

Suction elevator

FREER-GORNEY

CH-660-21 21,0 cm, 8 1/4"

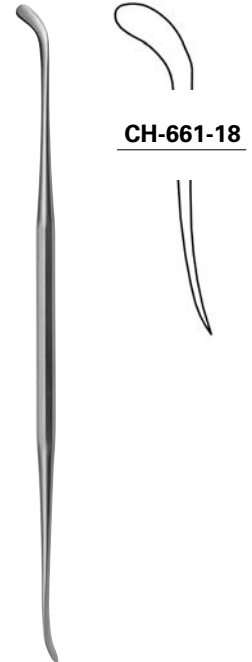

CH-661-18

FREER

CH-661-18 17,5 cm, 7"

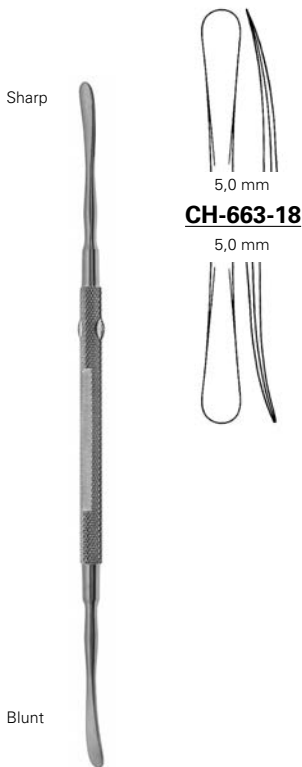

Sharp

5,0 mm
CH-663-18
5,0 mm

Blunt

FREER

CH-663-18 18,0 cm, 7"

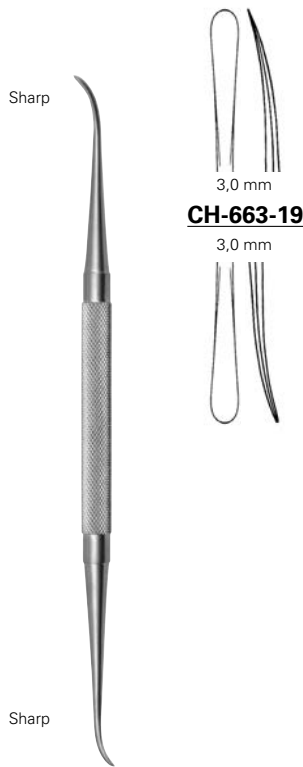

Sharp

3,0 mm
CH-663-19
3,0 mm

Sharp

FREER-YASARGIL

CH-663-19 18,5 cm, 7 1/4"

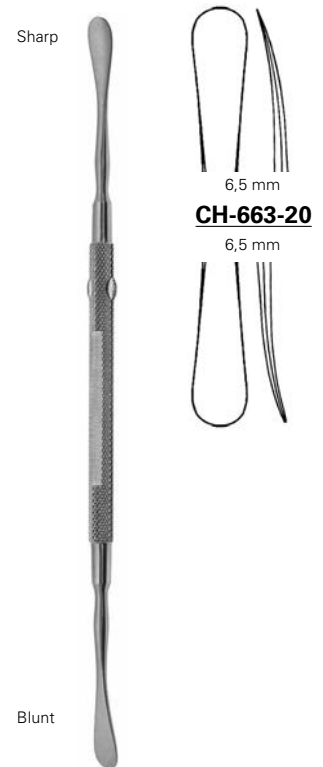

Sharp

6,5 mm
CH-663-20
6,5 mm

Blunt

FREER

CH-663-20 20,0 cm, 8"

Septum Elevators



FREER-JOSEPH

CH-663-21 20,0 cm, 8"



FREER

CH-665-20 20,0 cm, 8"



FREER

CH-668-19 19,0 cm, 7 1/2"



FREER

CH-669-01 19,0 cm, 7 1/2"



FREER

CH-669-02 19,0 cm, 7 1/2"



FREER

CH-669-03 19,0 cm, 7 1/2"

Septum Elevators



CH-670-17 17,0 cm, 6 3/4"

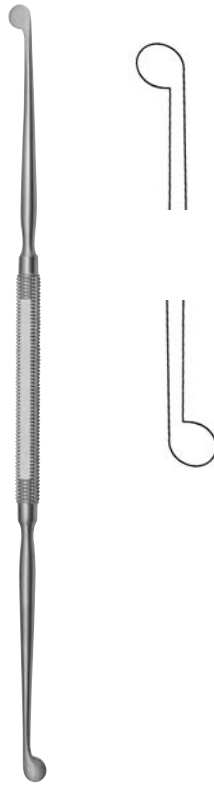

PIERCE
CH-672-21 21,0 cm, 8 1/4"

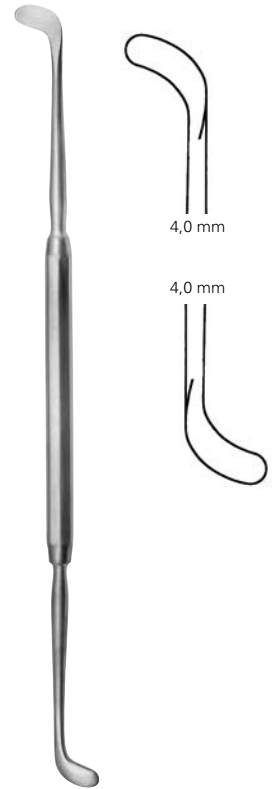

PENNINGTON
CH-673-21 21,0 cm, 8 1/4"

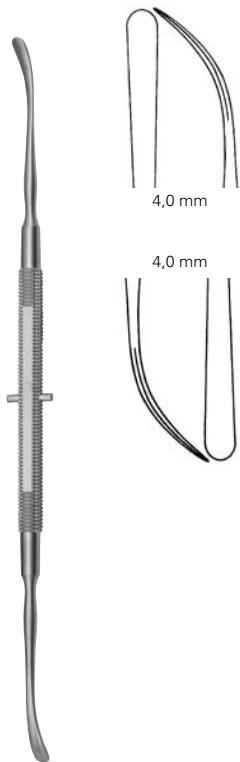

ROGER
CH-675-19 19,0 cm, 7 1/2"

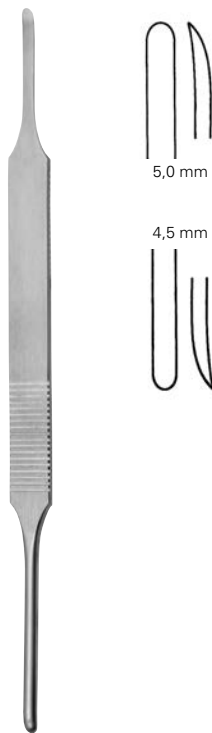

MC KENTY
CH-678-19 19,0 cm, 7 1/2"

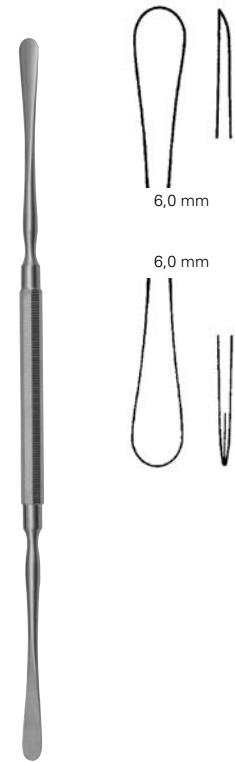

BALLENGER-HAJEK
CH-679-20 19,0 cm, 7 1/2"

Septum Elevators

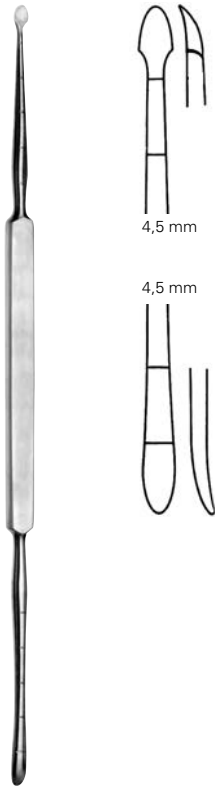

4,5 mm

4,5 mm

COTTLE

CH-679-21 21,0 cm, 8 ¼"

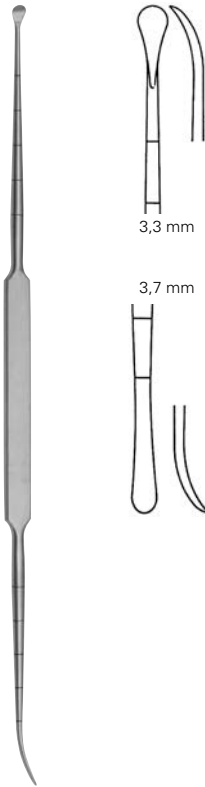

3,3 mm

3,7 mm

COTTLE

CH-681-21 21,0 cm, 8 ¼"

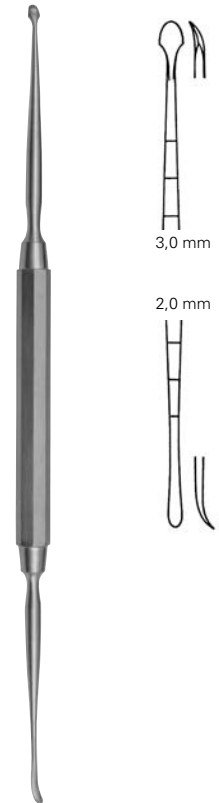

3,0 mm

2,0 mm

MASING

CH-681-22 22,0 cm, 8 ¾"

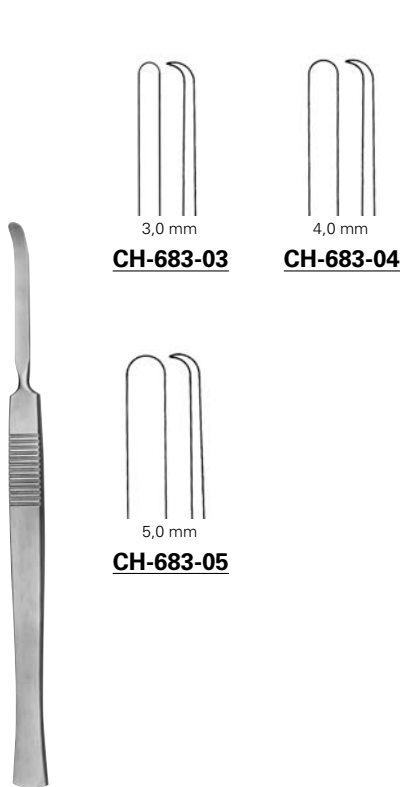

3,0 mm

CH-683-03

4,0 mm

CH-683-04

5,0 mm

CH-683-05

MC KENTY

CH-683-03 - CH-683-05 15,0 cm, 6"



6,5 mm

JOSEPH

CH-687-16 16,0 cm, 6 ¼"



4,0 mm

JOSEPH-MASING

CH-688-22 22,0 cm, 8 ¾"

Septum Elevators, Suction Raspatories



KILLIAN

26-689-18 18,0 cm, 7"

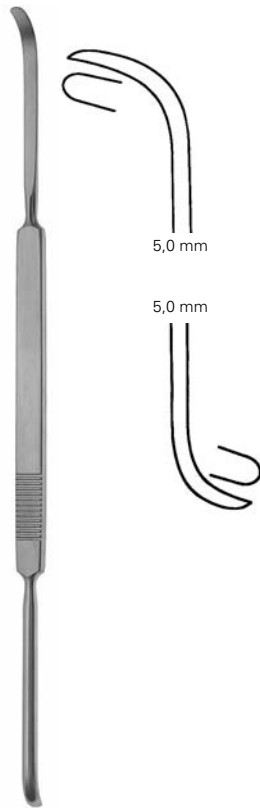

COTTLE

CH-693-22 23,0 cm, 9"



HOWARTH

26-695-22 21,5 cm, 8 1/2"



GUILEN

CH-697-14 14,5 cm, 5 3/4"



GUILEN

CH-698-14 14,5 cm, 5 3/4"



CH-699-20 20,0 cm, 8"

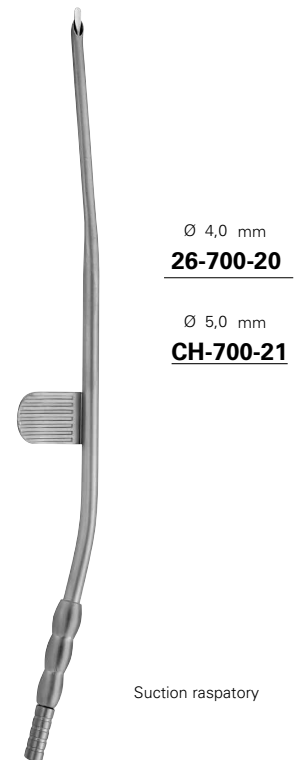

CH-700-20 20,0 cm, 8"

CH-700-21 20,0 cm, 8"

Septum Gouges

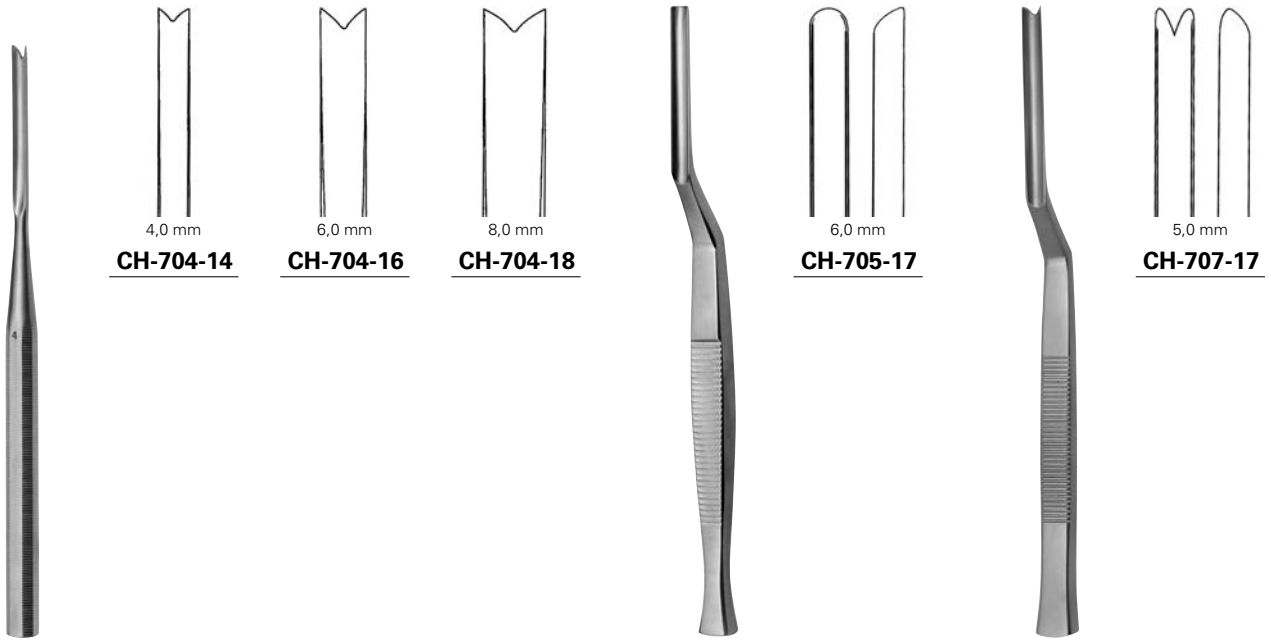

BALLENGER

CH-704-14 - CH-704-18 15,5 cm, 6"

KILLIAN

CH-705-17 17,0 cm, 6 3/4"

KILLIAN-CLAUS

CH-707-17 17,0 cm, 6 3/4"

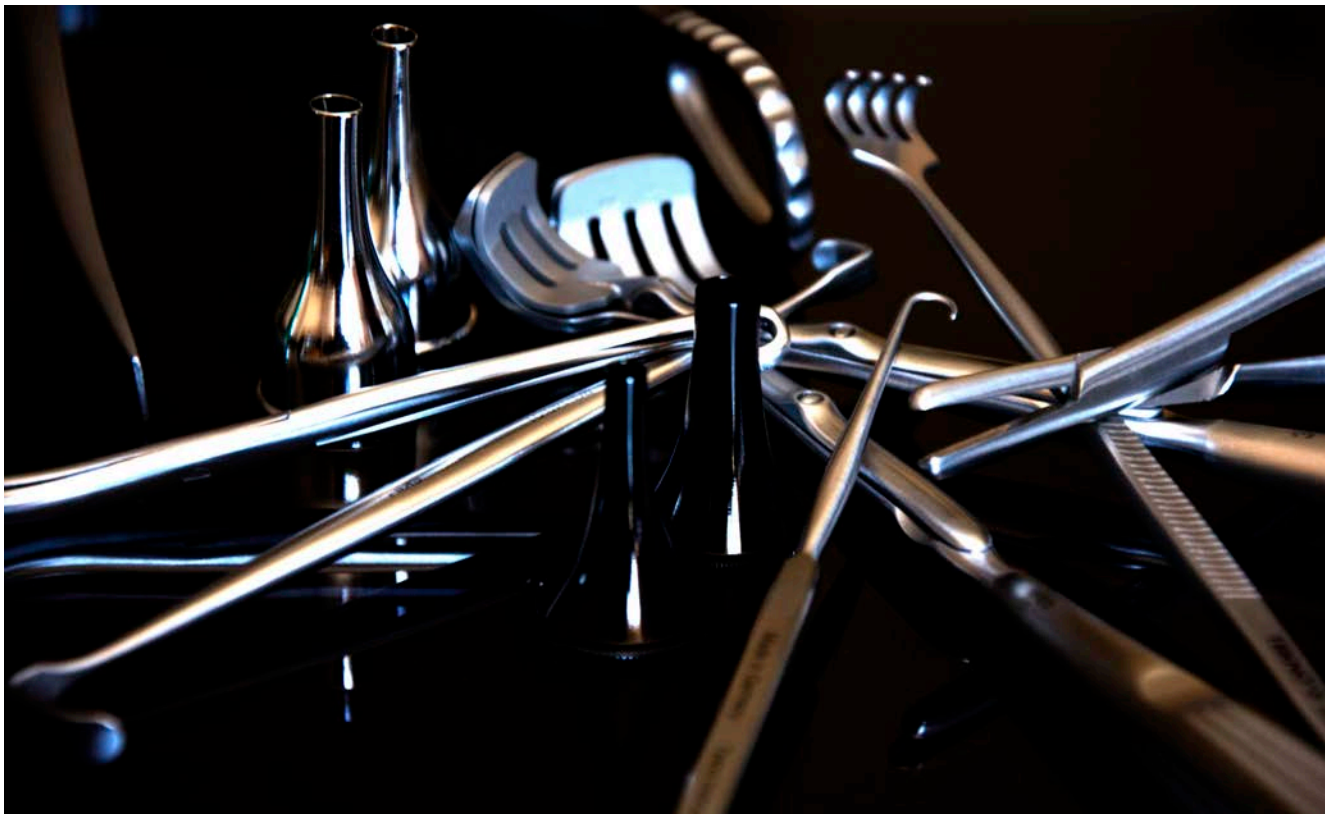

Osteotomes, Chisels

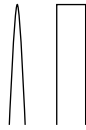

| | |
|------------------|---------|
| CH-278-04 | 4,0 mm |
| CH-278-06 | 6,0 mm |
| CH-278-08 | 8,0 mm |
| CH-278-10 | 10,0 mm |
| CH-278-12 | 12,0 mm |

Osteotomes, graduated

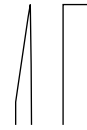

| | |
|------------------|---------|
| CH-279-04 | 4,0 mm |
| CH-279-05 | 5,0 mm |
| CH-279-06 | 6,0 mm |
| CH-279-07 | 7,0 mm |
| CH-279-09 | 9,0 mm |
| CH-279-12 | 12,0 mm |

Chisels, graduated

COTTLE

CH-278-04 - CH-278-12 18,0 cm, 7 "

COTTLE

CH-279-04 - CH-279-12 18,0 cm, 7 "



CH-721-06
Osteotome, graduated

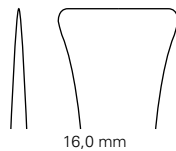

CH-724-16
Osteotome, graduated

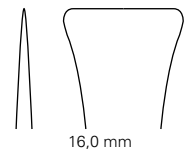

CH-726-16
Osteotome, graduated

COTTLE

CH-721-06 18,0 cm, 7 "

COTTLE

CH-724-16 18,0 cm, 7 "

COTTLE

CH-726-16 18,0 cm, 7 "

Osteotomes, Chisels

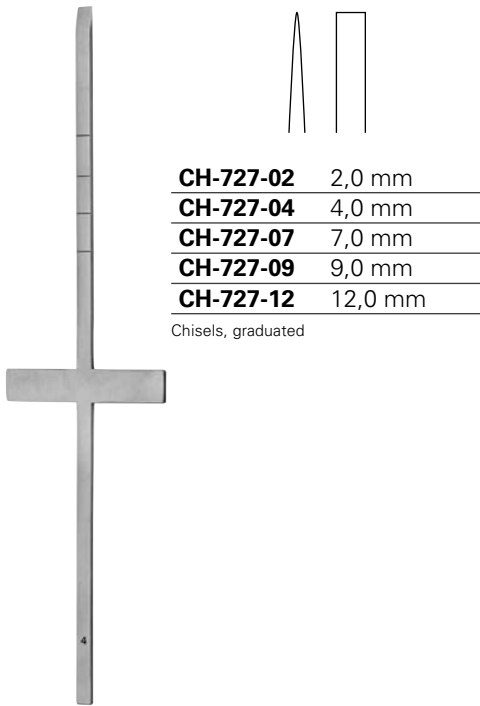

| | |
|------------------|---------|
| CH-727-02 | 2,0 mm |
| CH-727-04 | 4,0 mm |
| CH-727-07 | 7,0 mm |
| CH-727-09 | 9,0 mm |
| CH-727-12 | 12,0 mm |

Chisels, graduated

COTTLE

CH-727-02 - CH-727-12 18,5 cm, 7 ¼"

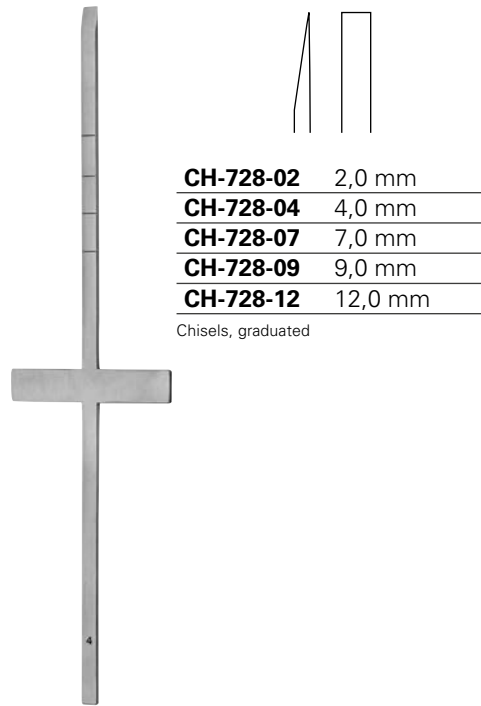

| | |
|------------------|---------|
| CH-728-02 | 2,0 mm |
| CH-728-04 | 4,0 mm |
| CH-728-07 | 7,0 mm |
| CH-728-09 | 9,0 mm |
| CH-728-12 | 12,0 mm |

Chisels, graduated

COTTLE

CH-728-02 - CH-728-12 18,5 cm, 7 ¼"

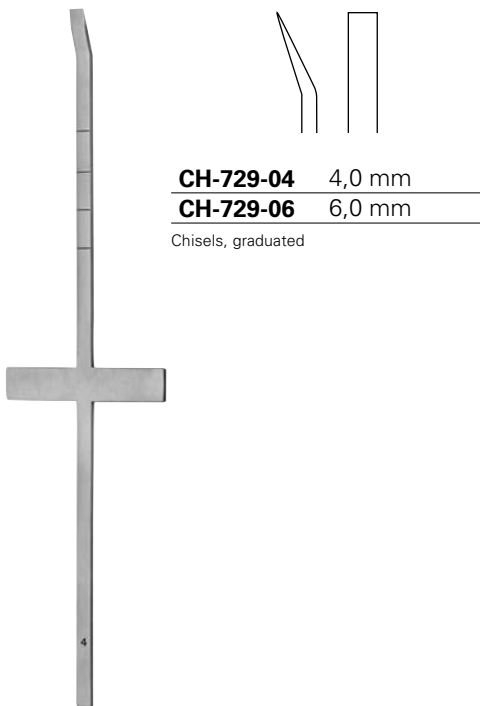

| | |
|------------------|--------|
| CH-729-04 | 4,0 mm |
| CH-729-06 | 6,0 mm |

Chisels, graduated

COTTLE

CH-729-04 - CH-729-06 18,5 cm, 7 ¼"

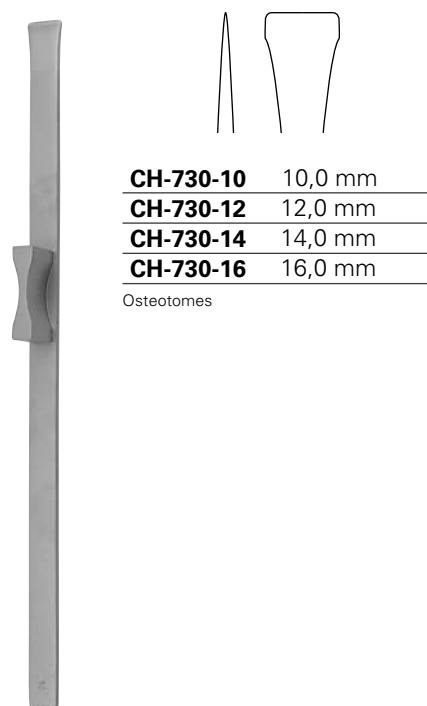

| | |
|------------------|---------|
| CH-730-10 | 10,0 mm |
| CH-730-12 | 12,0 mm |
| CH-730-14 | 14,0 mm |
| CH-730-16 | 16,0 mm |

Osteotomes

RUBIN

CH-730-10 - CH-730-16 18,0 cm, 7"

Osteotomes, Chisels

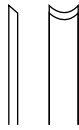

| | |
|------------------|--------|
| CH-732-03 | 3,0 mm |
| CH-732-04 | 4,5 mm |

Chisels

WALTER

CH-732-03 - CH-732-04 18,0 cm, 7 "

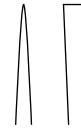

| | |
|------------------|---------|
| CH-733-02 | 2,0 mm |
| CH-733-03 | 3,0 mm |
| CH-733-04 | 4,0 mm |
| CH-733-07 | 7,0 mm |
| CH-733-09 | 9,0 mm |
| CH-733-12 | 12,0 mm |

Osteotomes

WALTER

CH-733-03 - CH-733-12 18,0 cm, 7 "

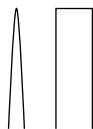

| | |
|------------------|---------|
| CH-734-01 | 1,0 mm |
| CH-734-02 | 2,0 mm |
| CH-734-03 | 3,0 mm |
| CH-734-04 | 4,0 mm |
| CH-734-05 | 5,0 mm |
| CH-734-06 | 6,0 mm |
| CH-734-07 | 7,0 mm |
| CH-734-08 | 8,0 mm |
| CH-734-10 | 10,0 mm |
| CH-734-12 | 12,0 mm |

Osteotomes

SHEEHAN

CH-734-01 - CH-734-12 15,5 cm, 6 1/8 "

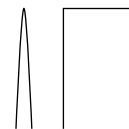

| | |
|------------------|---------|
| CH-735-02 | 2,0 mm |
| CH-735-03 | 3,0 mm |
| CH-735-04 | 4,0 mm |
| CH-735-05 | 5,0 mm |
| CH-735-06 | 6,0 mm |
| CH-735-07 | 7,0 mm |
| CH-735-08 | 9,0 mm |
| CH-735-09 | 9,0 mm |
| CH-735-10 | 10,0 mm |
| CH-735-11 | 11,0 mm |
| CH-735-12 | 12,0 mm |
| CH-735-14 | 14,0 mm |

Osteotomes

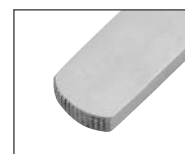

CONVERSE

CH-735-02 - CH-735-14 18,0 cm, 7 "

Osteotomes

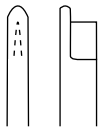

| | |
|------------------|--------|
| CH-736-04 | 4,0 mm |
| CH-736-05 | 5,0 mm |
| CH-736-06 | 6,0 mm |
| CH-736-07 | 7,0 mm |

Osteotomes

FOMON

CH-736-04 - CH-736-07 17,0 cm, 6 3/4"

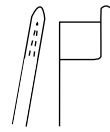

CH-737-01
7,0 mm
Curved to right

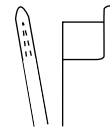

CH-737-02
7,0 mm
Curved to left

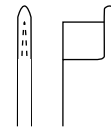

CH-737-03
7,0 mm
Straight

Osteotomes

NEIVERT-ANDERSON

CH-737-01 - CH-737-03 20,5 cm, 8"

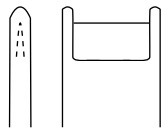

| | |
|------------------|---------|
| CH-740-10 | 10,0 mm |
| CH-740-12 | 12,0 mm |
| CH-740-14 | 14,0 mm |
| CH-740-16 | 16,0 mm |

Osteotomes

CINELLI

CH-740-10 - CH-740-16 16,0 cm, 6 1/4"

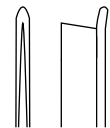

CH-741-01
5,0 mm
Straight

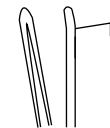

CH-741-02
5,0 mm
Curved to left



CH-741-03
5,0 mm
Curved to right to right

Osteotomes

SILVER

CH-741-01 - CH-741-03 17,5 cm, 7"

Osteotomes, Sharpening Stones

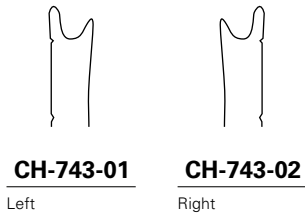

CH-743-01
Left

CH-743-02
Right

Osteotomes

GUSTELLA

CH-743-01 - CH-743-02 17,5 cm, 7 "

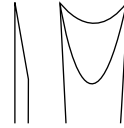

- CH-744-09** 9,0 mm
- CH-744-11** 11,0 mm
- CH-744-13** 13,0 mm
- CH-744-15** 15,0 mm

Osteotomes

MC INDOE

CH-744-09 - CH-744-15 14,5 cm, 5 3/4 "



ARKANSAS

CH-398-00 10,0 x 4,0 cm



ARKANSAS

CH-399-00 15,0 x 5,0 cm

Mallets



HW Head weight

TW Total weight



HW 320 g
TW 420 g
Ø 26,0 mm

CH-200-22

Spare discs



HW 140 g
TW 240 g
Ø 25,0 mm

CH-201-99

Spare discs



HW 240 g
TW 340 g
Ø 30,0 mm

CH-202-30

1 Side flat
Side convex

MEAD

CH-200-20 19,0 cm, 7 ½"

MEAD

CH-201-25 18,5 cm, 7 ¼"

COTTLE

CH-202-30 19,0 cm, 7 ½"



HW 100 g
TW 140 g

Ø 20,0 mm

CH-203-22

Lead filled head



HW 160 g
TW 220 g

Ø 22,0 mm

CH-204-22

Lead filled head



HW 160 g
TW 220 g

Ø 27,0 mm

CH-205-27

HAJEK

CH-205-27 20,0 cm, 8"

CH-203-22 16,5 cm, 6 ½"

CH-204-22 19,0 cm, 7 ½"

Rhinoplastic Knives

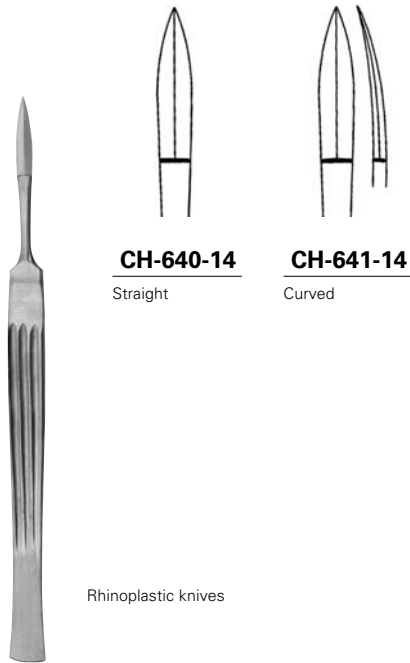

CH-640-14
Straight

CH-641-14
Curved

Rhinoplastic knives



CH-642-99
Spare blade

Septum knife

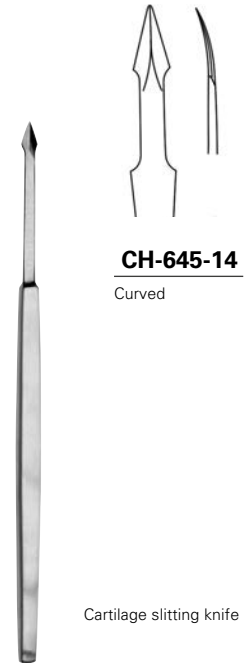

CH-645-14
Curved

Cartilage slitting knife

JOSEPH

CH-640-14 - CH-641-14 14,5 cm, 5 3/4 "

BRUENINGS

CH-642-16 16,0 cm, 6 1/4 "

MASING

CH-645-14 14,0 cm, 5 1/2 "



CH-644-13
Curved

Cartilage slitting knife



CH-644-14
Straight

Cartilage slitting knife

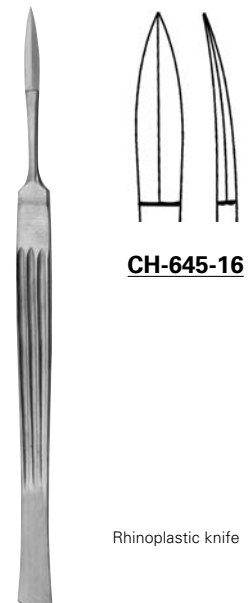

CH-645-16

Rhinoplastic knife

MASING

CH-644-13 13,5 cm, 5 1/4 "

MASING

CH-644-14 13,5 cm, 5 1/4 "

FOMON

CH-645-16 16,0 cm, 6 1/4 "

Rhinoplastic Knives



CH-646-15

Mucosa knife

FREER

CH-646-15 15,5 cm, 6 1/8"



CH-649-16

Rhinoplastic knife

CONVERSE

CH-649-16 16,0 cm, 6 1/4"



CH-650-15

Rhinoplastic knife

JOSEPH

CH-650-15 15,0 cm, 6"



CH-652-15

Rhinoplastic knife

COTTLE

CH-652-15 15,0 cm, 6"



CH-654-15

Rhinoplastic knife

COTTLE

CH-654-15 15,0 cm, 6"



Scalpel Handles, Mini-/ Scalpel Blades, Sterile

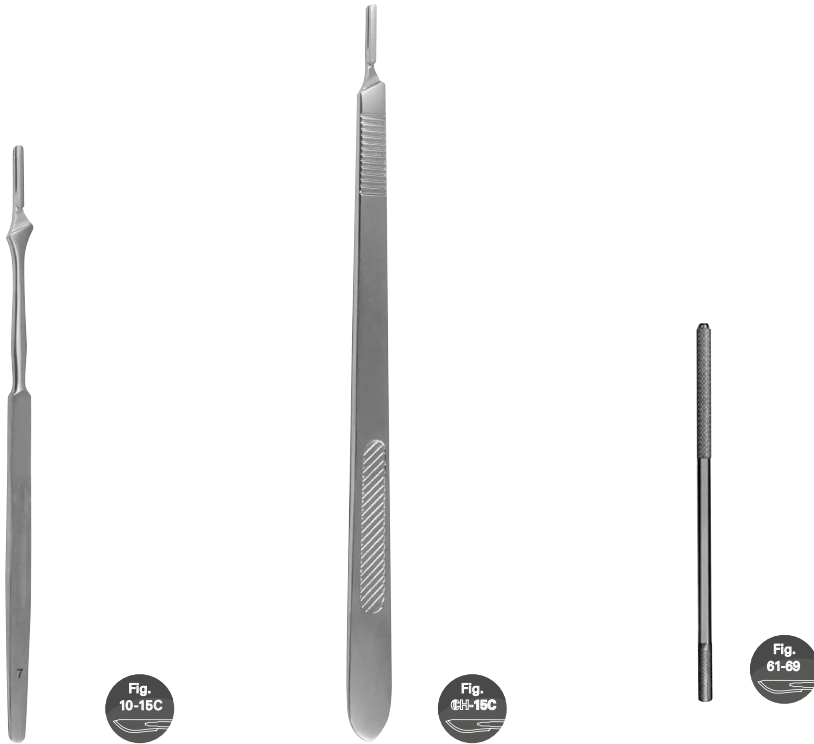

Nr. 7
CH-103-06 16,0 cm, 6 ¼"

Nr. 3 L
CH-103-04 21,0 cm, 8 ¼"

| | |
|------------------|---------------|
| CH-260-10 | 10,0 cm, 4" |
| CH-260-13 | 13,0 cm, 5 ⅛" |
| CH-260-15 | 15,5 cm, 6 ⅛" |



FIG. 61
CH-265-61



FIG. 62
CH-265-62



FIG. 62S
CH-265-63



FIG. 64
CH-265-64



FIG. 65
CH-265-65



FIG. 67
CH-265-67



FIG. 69
CH-265-69



Fig. 10
CH-153-10



Fig. 11
CH-153-11



Fig. 15
CH-153-15

Nasal Retractors, Alar Nasal Hooklets



WALTER

CH-769-13 13,5 cm, 5 ¼"



KILNER

CH-770-10 8,0 cm, 3 ¼"



10,0 mm

CH-770-10

Sharp



COTTLE

CH-770-15 15,0 cm, 6"



4,0 mm

CH-770-15

Sharp



CONVERSE

CH-771-12 12,0 cm, 4 ¾"



CH-771-12

Sharp



COTTLE

CH-772-01 - CH-772-03 15,0 cm, 6"



CH-772-01

Sharp



CH-772-02

Sharp



CH-772-03

Sharp



COTTLE

CH-774-16 16,0 cm, 6 ¼"



CH-774-16

Sharp



FOMON

CH-776-17 17,0 cm, 6 ¾"



CH-776-17

Finger Ring Hooks, Nasal Retractors, Alar Nasal Hooklets



FOMON

CH-777-00 5,5 cm, 2 1/8"



COTTLE

CH-778-01 - CH-778-03 14,5 cm, 5 3/4"



CH-778-01
Sharp | Sharp



CH-778-02
Blunt | Sharp



CH-778-03
Sharp | Blunt



COTTLE

CH-778-04 14,0 cm, 5 1/2"



CH-778-04
Blunt



10,0 mm
CH-779-05
Sharp



MILLARD (COTTLE)

CH-779-05 5,5 cm, 2 1/8"



FOMON

CH-779-16 16,0 cm, 6 1/4"



CH-779-16
Blunt | Blunt



COTTLE-NEIVERT

CH-780-20 20,0 cm, 8"



CH-780-20



Nasal Retractors



Alar Hooklet

CH-782-16

NEIVERT

CH-782-16 16,0 cm, 6 ¼"



6,0 x 12,0 mm
CH-783-01



10,0 x 12,0 mm
CH-783-02

MASING

CH-783-01 - CH-783-02 14,0 cm, 5 ½"



COTTLE

CH-785-15 15,0 cm, 6"

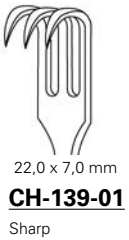

22,0 x 7,0 mm
CH-139-01
Sharp

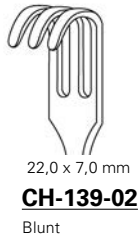

22,0 x 7,0 mm
CH-139-02
Blunt



18,0 x 6,0 mm
CH-139-03
Sharp

SENN-MILLER

CH-139-01 - CH-139-03 16,0 cm, 6 ¼"

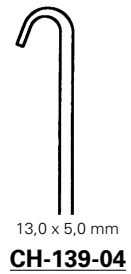

13,0 x 5,0 mm
CH-139-04

KILNER

CH-139-04 15,5 cm, 6"

Delicate Surgical Scissors

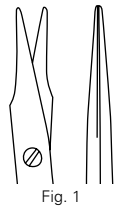

Fig. 1

CH-432-10
CH-432-11

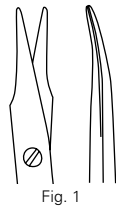

Fig. 1

CH-433-10
CH-433-11

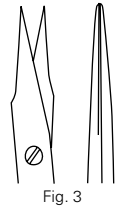

Fig. 3

CH-434-10
CH-434-11



Fig. 3

CH-435-10
CH-435-11

STEVENS

CH-432-10 - CH-435-10 10,0 cm, 4 "

CH-432-11 - CH-435-11 11,0 cm, 4 $\frac{3}{8}$ "

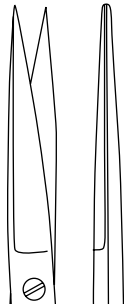

CH-404-14
CH-404-17



CH-405-14
CH-405-17

JOSEPH

CH-404-14 - CH-405-14 14,0 cm, 5 $\frac{1}{2}$ "

CH-404-17 - CH-405-17 17,0 cm, 6 $\frac{3}{4}$ "

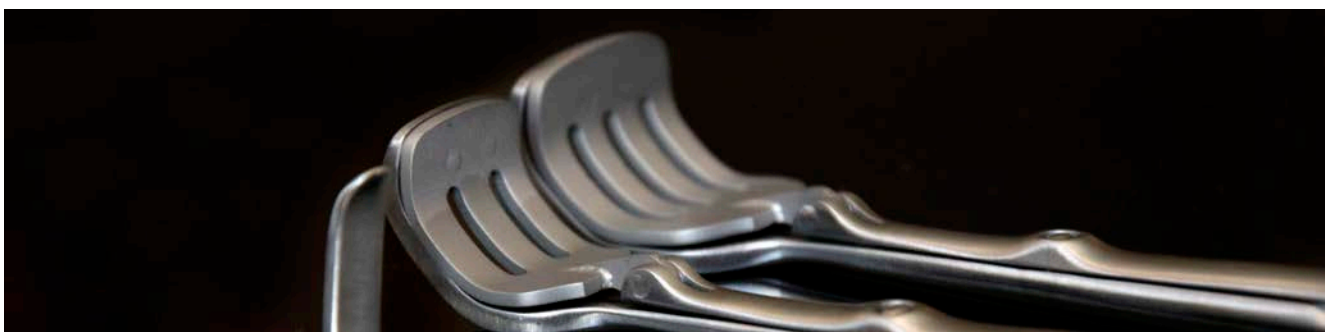

Delicate Surgical Scissors, TC, SUPERCUT

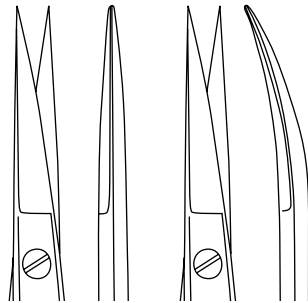
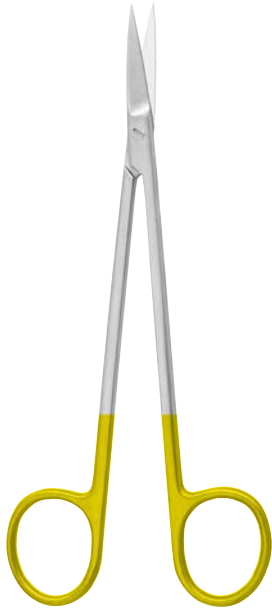

CH-400-16

CH-401-16

KELLY

CH-400-16 - CH-401-16 16,0 cm, 6 ¼"

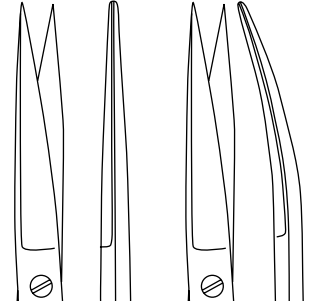
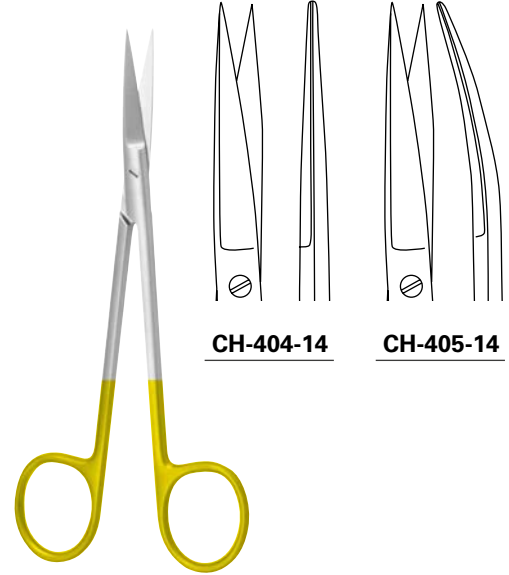

CH-404-14

CH-405-14

JOSEPH

CH-404-14 - CH-405-14 14,0 cm, 5 ½"

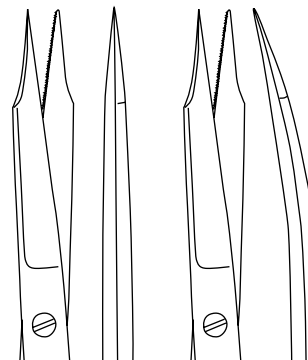

12-416-13

12-417-13

GOLDMANN-FOX

CH-416-13 - CH-417-13 13,0 cm, 5 ⅛"

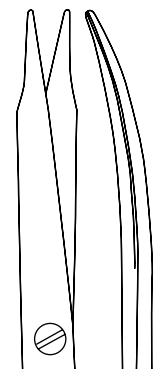
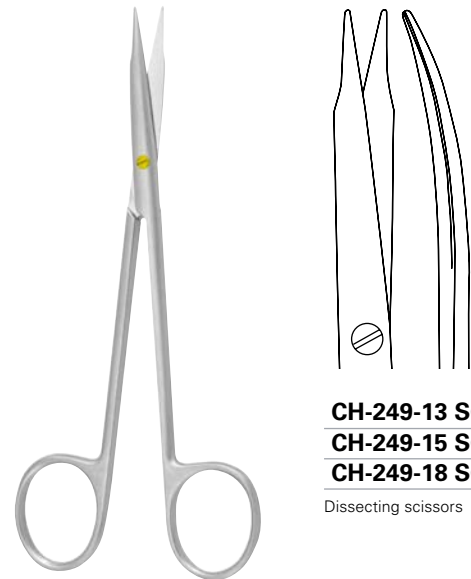

CH-249-13 SC
CH-249-15 SC
CH-249-18 SC

Dissecting scissors

REYNOLDS

CH-249-13 SC 13,0 cm, 5 ⅛"

CH-249-15 SC 15,0 cm, 6"

CH-249-18 SC 18,0 cm, 7"

Dissecting Scissors

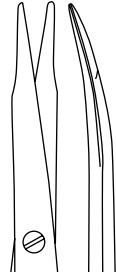

CH-247-13
CH-247-15

JAMESON

CH-247-13 13,0 cm, 5 1/8"
CH-247-15 15,0 cm, 6"



CH-244-12

KILNER (RAGNELL)

CH-244-12 12,0 cm, 4 3/4"

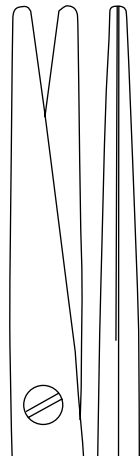

CH-230-16



CH-231-16

LEXER

CH-230-16 - CH-231-16 16,0 cm, 6 1/4"

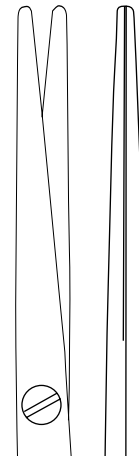

CH-232-16

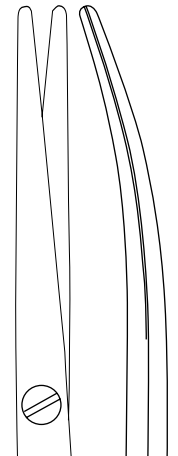

CH-233-16

LEXER-FINO

CH-232-16 - CH-233-16 16,0 cm, 6 1/4"

Dissecting Scissors, TC

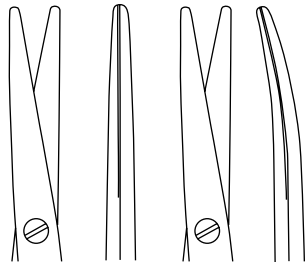

CH-234-10

CH-235-10

LEXER-BABY

CH-234-10 - CH-235-10 10,0 cm, 4"

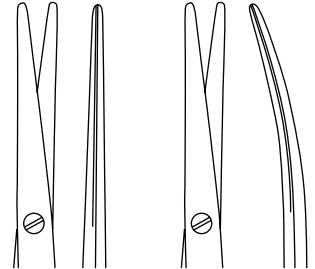

CH-236-09
CH-236-11

CH-237-09
CH-237-11

STRABISMUS

CH-236-09 - CH-237-09 9,0 cm, 3 1/2"
CH-236-11 - CH-237-11 11,0 cm, 4 3/8"



CH-245-12
CH-245-15

KILNER

CH-245-12 12,0 cm, 4 3/4"
CH-245-15 15,0 cm, 5"

Nasal Raspers

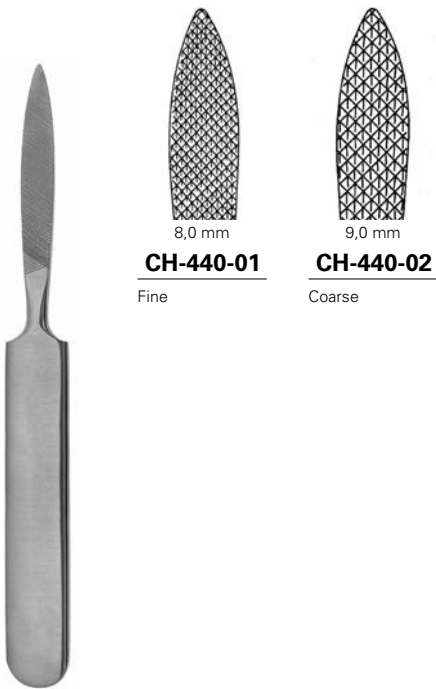

CH-440-01
Fine

CH-440-02
Coarse

JOSEPH

CH-440-01 - CH-440-02 16,5 cm, 6 ½"

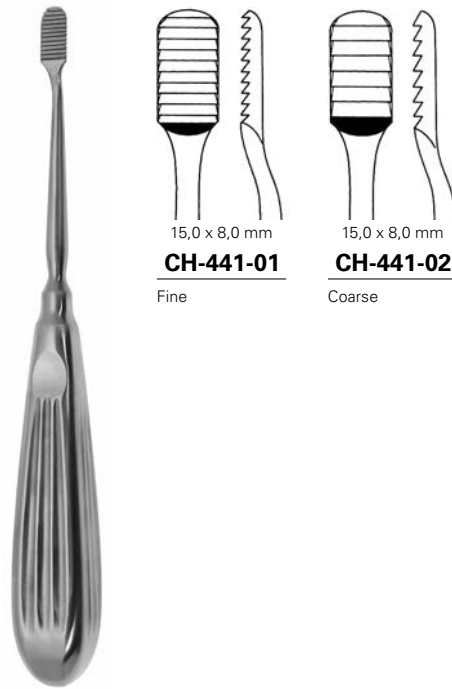

CH-441-01
Fine

CH-441-02
Coarse

LEWIS

CH-441-01 - CH-441-02 18,0 cm, 7"

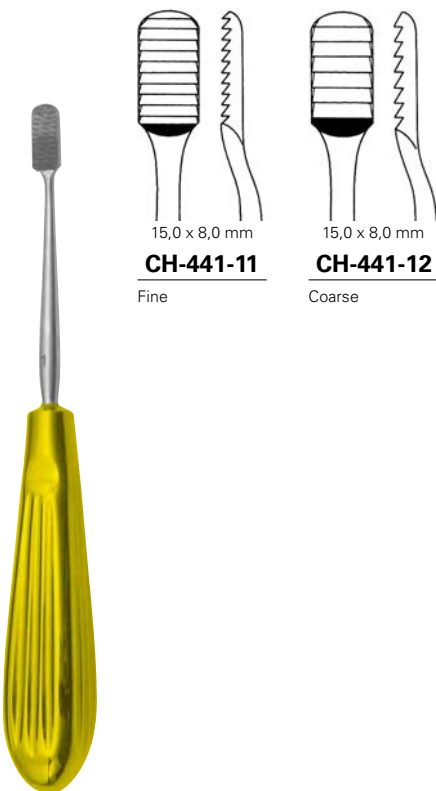

CH-441-11
Fine

CH-441-12
Coarse

LEWIS

CH-441-11 - CH-441-12 18,0 cm, 7"



CH-441-21
Fine

COTTLE

CH-441-21 21,0 cm, 8 ¼"



CH-442-21
Downwards stroke

COTTLE

CH-442-21 21,0 cm, 8 ¼"

Nasal Raspers, TC



CH-442-01
Upwards stroke



CH-442-02
Downwards stroke



40,0 x 9,0 mm
CH-442-18
Downwards stroke

MALTZ

CH-442-01 - CH-442-02 17,5 cm, 7"

MALTZ

CH-442-18 18,0 cm, 7"

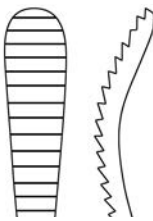

32,0 x 9,0 mm
CH-443-01
Upwards stroke

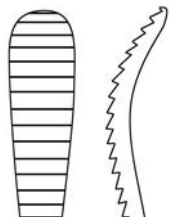

32,0 x 9,0 mm
CH-443-02
Downwards stroke

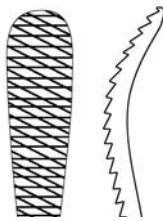

32,0 x 9,0 mm
CH-443-03
Upwards stroke

Downwards stroke



45,0 x 6,0 mm
CH-444-01



45,0 x 6,0 mm
CH-444-02



45,0 x 6,0 mm
CH-444-03



AUFRICHT

CH-443-01 - CH-443-03 21,0 cm, 8 1/4"

GALLAHER

CH-444-01 - CH-444-03 17,0 cm, 6 3/4"

Nasal Rasps, TC

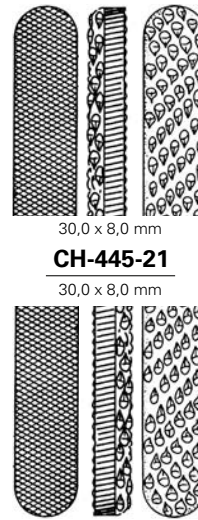
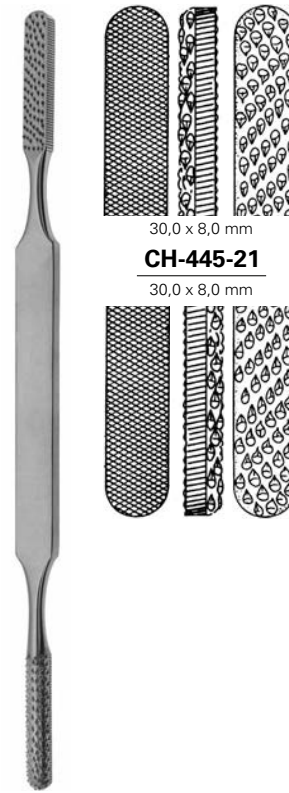
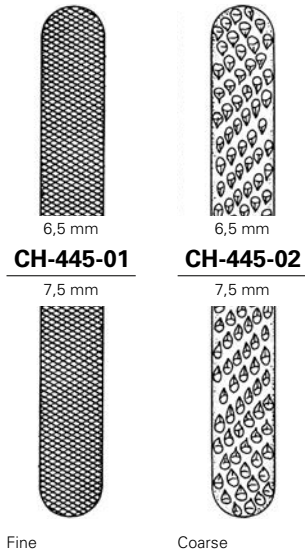

FOMON

CH-445-01 - CH-445-02 21,0 cm, 8 ¼"

FOMON

CH-445-21 21,0 cm, 8 ¼"

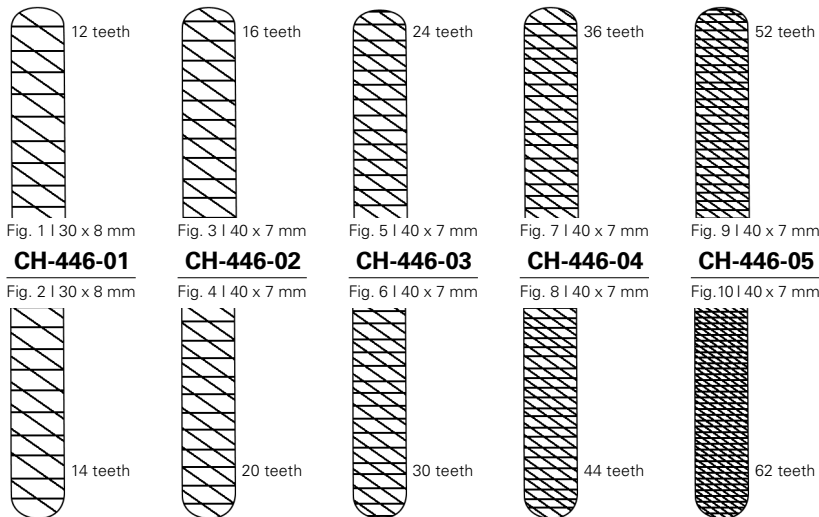

CH-446-01 - CH-446-05 20,5 cm, 8"

Nasal Raspers, TC



| | |
|------------------|---------------|
| CH-446-11 | Fig. 1 12T |
| CH-446-12 | Fig. 2 14T |
| CH-446-13 | Fig. 3 16T |
| CH-446-14 | Fig. 4 20T |
| CH-446-15 | Fig. 5 24T |
| CH-446-16 | Fig. 6 30T |
| CH-446-17 | Fig. 7 36T |
| CH-446-18 | Fig. 8 44T |
| CH-446-19 | Fig. 9 52T |
| CH-446-20 | Fig. 10 62T |

T = teeth

PARKS

CH-446-11 - CH-446-20 21,0 cm, 8 ¼ "



| | |
|------------------|---------------|
| CH-446-21 | Fig. 1 12T |
| CH-446-22 | Fig. 2 14T |
| CH-446-23 | Fig. 3 16T |
| CH-446-24 | Fig. 4 20T |
| CH-446-25 | Fig. 5 24T |
| CH-446-26 | Fig. 6 30T |
| CH-446-27 | Fig. 7 36T |
| CH-446-28 | Fig. 8 44T |
| CH-446-29 | Fig. 9 52T |
| CH-446-30 | Fig. 10 62T |

T = teeth

MALTZ

CH-446-21 - CH-446-30 17,0 cm, 6 ¾ "

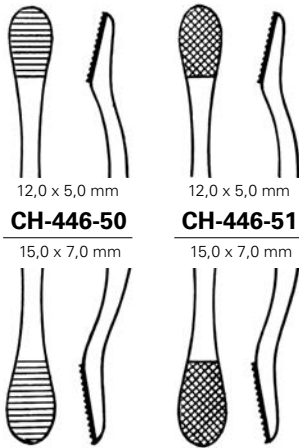

MILLER

CH-446-50 - CH-446-51 19,0 cm, 7 ½ "

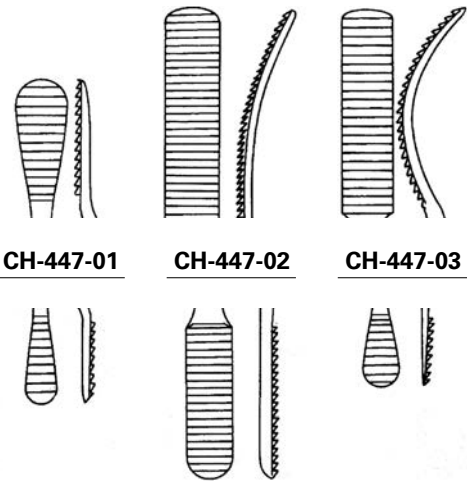

MILLER

CH-447-01 - CH-447-03 18,0 cm, 7 "

Nasal Rasps, TC

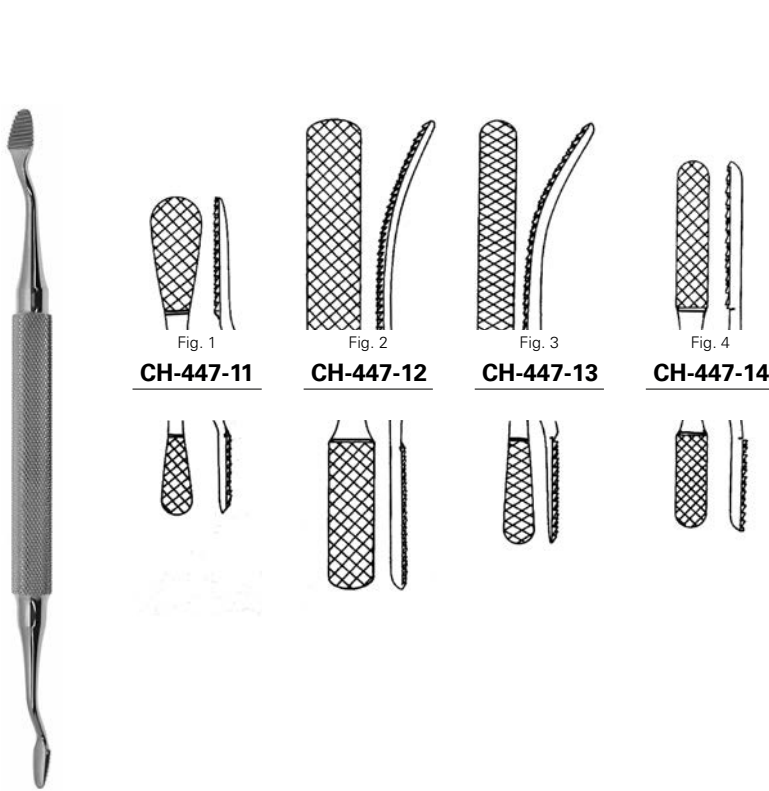

MILLER-COLBURN

CH-447-11 - CH-447-14 18,0 cm, 7 "



CH-448-22 22,0 cm, 8 3/4 "

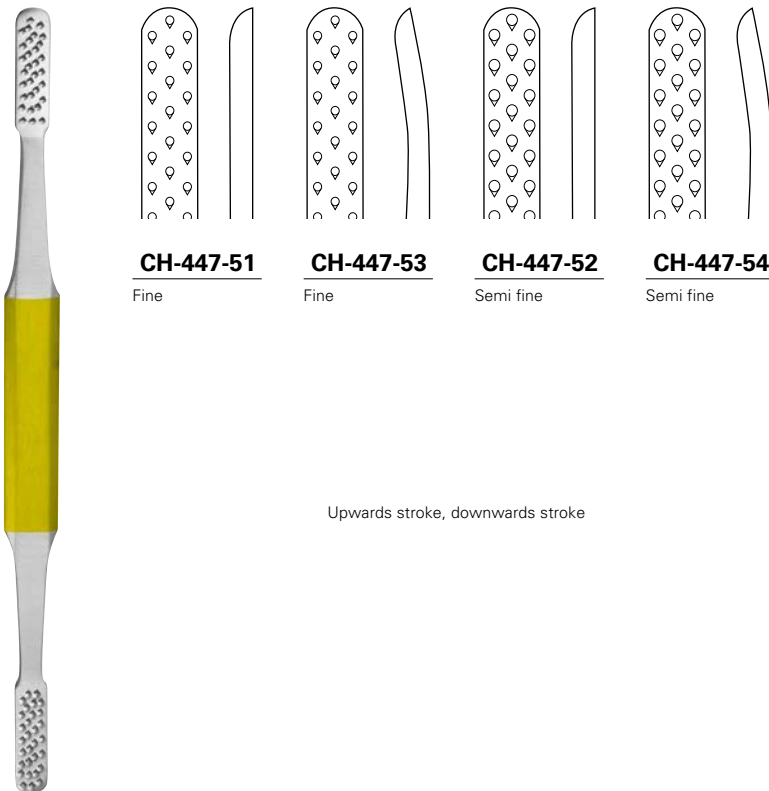

Upwards stroke, downwards stroke

OBWEGESER

CH-447-51 - CH-447-54 19,5 cm, 7 3/4 "

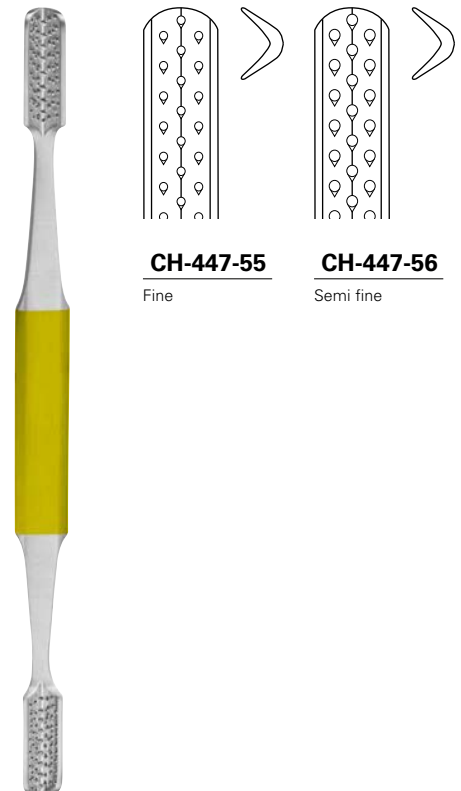

OBWEGESER

CH-447-55 - CH-447-56 19,5 cm, 7 3/4 "

Nasal Raspers with Diamond Jaw

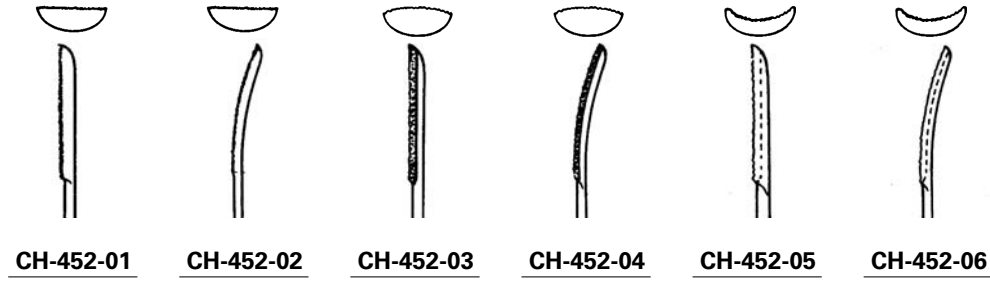

With diamond jaw

CH-452-01 - CH-452-06 19,0 cm, 7 1/2"



With diamond jaw

AUFRICHT

CH-453-20 20,0 cm, 8"



With diamond jaw

FOMON

CH-454-21 21,0 cm, 8 1/4"

Nasal Saws



Angled to left

JOSEPH

CH-751-01 17,0 cm, 6 3/4"



Angled to right

JOSEPH

CH-751-02 17,0 cm, 6 3/4"

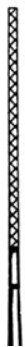

CH-752-01

Straight

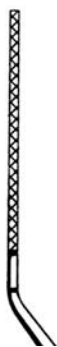

CH-752-02

Curved to left



CH-752-03

Curved to right

JOSEPH

CH-752-01 - CH-752-03 19,0 cm, 7 1/2"

Cartilage Crusher, Forceps



Die to pre-form wire prosthesis



SCHUHKNECHT

CH-754-00

Cartilage Crusher

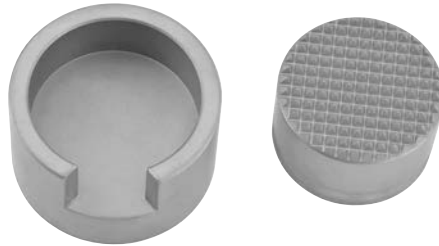

CH-755-00

Cartilage Crusher



COTTLE

CH-756-00

Columella forceps



COTTLE

CH-760-10 10,0 cm, 4"

Fixation forceps

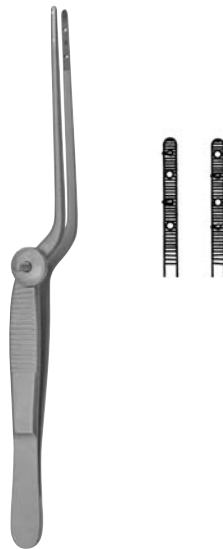

COTTLE

CH-761-14 14,0 cm, 5 1/2"

Skin grasping forceps

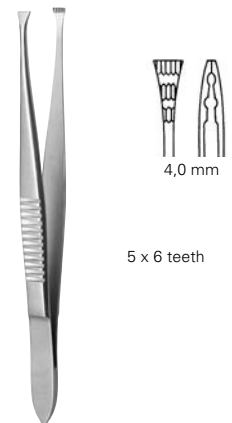

GRAEFE

CH-762-11 11,0 cm, 4 1/4"

**Examination and Measuring Instruments,
Nasal Fracture Elevators**



TOWNLEY

CH-036-11 100 mm

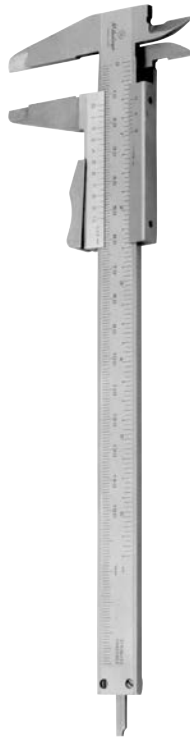

CH-036-15 150 mm



JAMESON

CH-036-81 80 mm



Ruler, graduated in cm and inches



- CH-032-10** 100 mm
- CH-032-15** 150 mm
- CH-032-20** 200 mm
- CH-032-30** 300 mm
- CH-032-50** 500 mm



CH-818-17 17,0 cm, 6 3/4 "



BOIES

CH-820-18 18,0 cm, 7 "



GOLDMANN

CH-822-20 20,0 cm, 8 "



Nasopharynx and Oral Cavity



Table of Content I Chapter











| Product group | Page |
|---|--|
|  | Laryngeal Mirrors, Rhinoscopic Mirror, Mirror Warmer / Optics Heater 235-236 |
|  | Laryngoscopes 237-239 |
|  | Naso-Pharyngeal Forceps 240 |
|  | Adenoid Currettes 241 |
|  | Adenotomes 243 |
|  | Powder Blowers 244 |
|  | Tongue Spatulas, Depressors and Mouth Gags 245 |

Table of Content I Chapter

| Product group | Page |
|---|----------------|
|  <p>Tongue Spatulas, Depressors, Mouth Gags Chest Support, Holding Drame, Tonsil, Trigeminal Knives</p> | 246-271 |
|  <p>Suction Tubes</p> | 272 |
|  <p>Tonsil Scissors, Cartilage Scissors</p> | 273-274 |
|  <p>Syringes, Tonsil Needles</p> | 275 |
|  <p>Salivary Duct Probes</p> | 276 |
|  <p>Bipolar Forceps with Irrigation</p> | 277-284 |

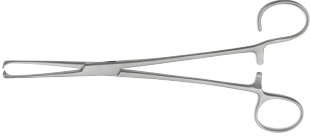
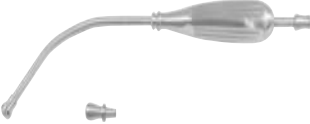
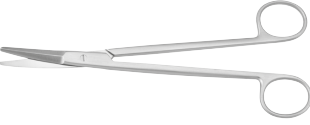
Laryngeal Mirrors, Rhinoscopic Mirrors

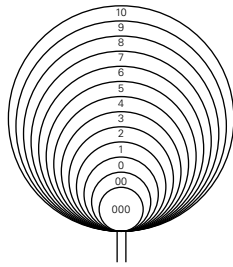

- CH-200-06** 6 mm | Fig. 000
- CH-200-08** 8 mm | Fig. 00
- CH-200-10** 10 mm | Fig. 0
- CH-200-12** 12 mm | Fig. 1
- CH-200-14** 14 mm | Fig. 2
- CH-200-16** 16 mm | Fig. 3
- CH-200-18** 18 mm | Fig. 4
- CH-200-20** 20 mm | Fig. 5
- CH-200-22** 22 mm | Fig. 6
- CH-200-24** 24 mm | Fig. 7
- CH-200-26** 26 mm | Fig. 8
- CH-200-28** 28 mm | Fig. 9
- CH-200-30** 30 mm | Fig. 10

Laryngeal mirrors, without handle



Metal handle



Metal handle

CH-200-06 - CH-200-30 14,0 cm, 5 ½ "

CH-201-00 10,0 cm, 4 "

CH-202-00 10,5 cm, 4 ¼ "

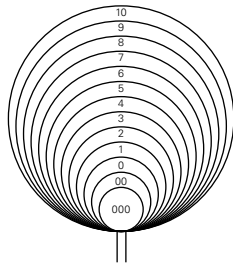

- CH-210-06** 6 mm | Fig. 000
- CH-210-08** 8 mm | Fig. 00
- CH-210-10** 10 mm | Fig. 0
- CH-210-12** 12 mm | Fig. 1
- CH-210-14** 14 mm | Fig. 2
- CH-210-16** 16 mm | Fig. 3
- CH-210-18** 18 mm | Fig. 4
- CH-210-20** 20 mm | Fig. 5
- CH-210-22** 22 mm | Fig. 6
- CH-210-24** 24 mm | Fig. 7
- CH-210-26** 26 mm | Fig. 8
- CH-210-28** 28 mm | Fig. 9
- CH-210-30** 30 mm | Fig. 10

Laryngeal mirrors, with fixed handle

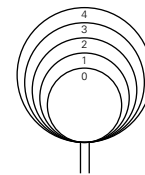

- CH-230-10** 10 mm | Fig. 0
- CH-230-12** 12 mm | Fig. 1
- CH-230-14** 14 mm | Fig. 2
- CH-230-16** 16 mm | Fig. 3
- CH-230-18** 18 mm | Fig. 4

Rhinoscopic mirrors, moveable

CH-210-06 - CH-210-30 19,0 cm, 7 ½ "

MICHEL

CH-230-10 - CH-230-18 25,0 cm, 9 ¾ "

Mirror Warmer/ Optics Heater**SKILL**
Optics Instruments**CH-225-90**

Infrared anti fog warmer for heating up mouth- and laryngeal mirrors or endoscopes.

Technical specification

| | |
|--------------------------------|---|
| Classification: | Class I (according annex IX 93/42/EWG) |
| Power supply: | Mains voltage 230 V |
| Power consumption: | 35 W |
| Temperature at focus point: | approx. 300 °C |
| Switching time: | 10 s |
| Dimension: | ø 86 x 140 mm |



Laryngoscopes

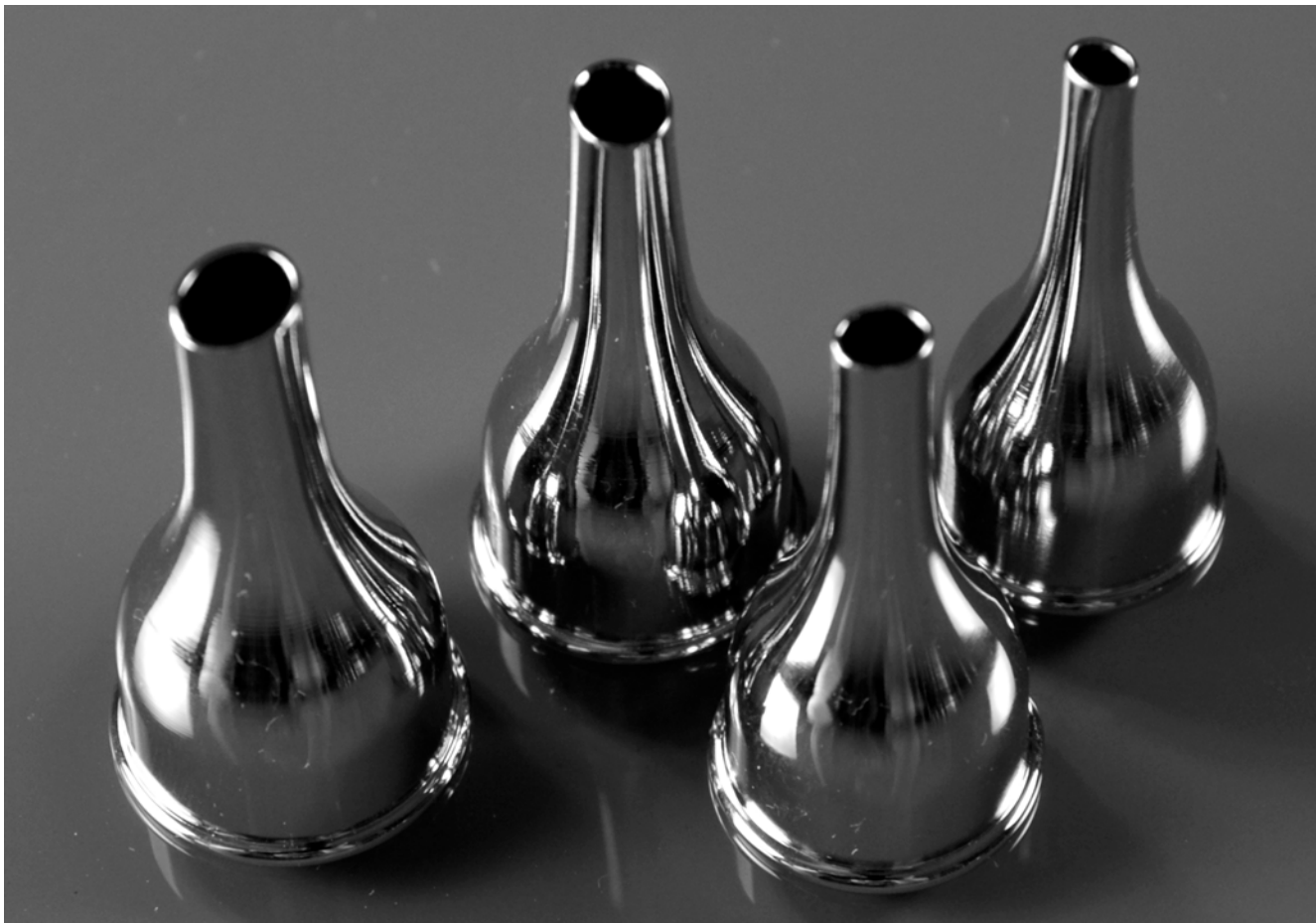
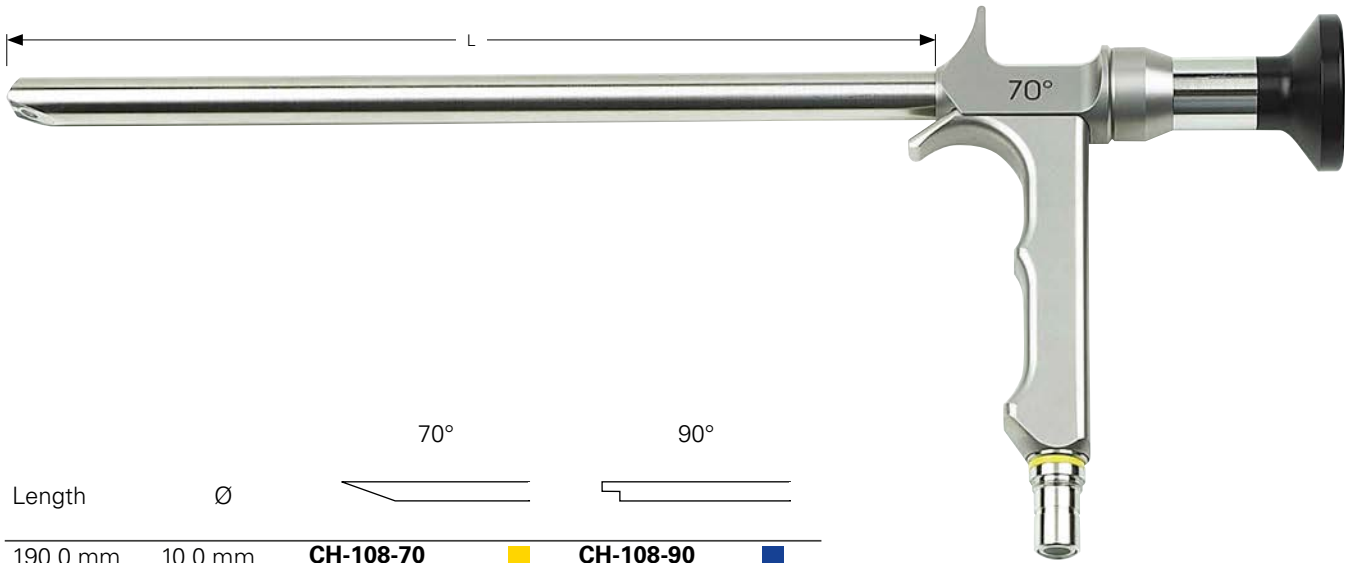

Flexible Naso-Pharyngo-/ Laryngofibrescopes

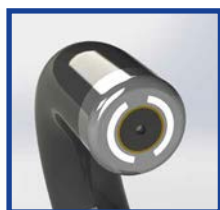
Accessoires:
- Leakage tester
- ETO-Cap

CH-149-00 Ø 2,2 mm

One hand control, 2-side angulation, length of angulated tip 20 mm

| Length | Fibre bundle | Angulation up down | Direction of view | Field of view | Depth of field |
|--------|--------------|----------------------|-------------------|---------------|----------------|
| 300 mm | 6.500 Pixel | 160° 160° | 0° | 88° | 3 - 50 mm |

CH-150-00 Ø 2,8 mm

One hand control, 2-side angulation, length of angulated tip 20 mm

| Length | Fibre bundle | Angulation up down | Direction of view | Field of view | Depth of field |
|--------|--------------|----------------------|-------------------|---------------|----------------|
| 300 mm | 16.000 Pixel | 160° 160° | 0° | 85° | 1 - 50 mm |

CH-152-00 Ø 3,2 mm

One hand control, 2-side angulation, length of angulated tip 20 mm

| Length | Fibre bundle | Angulation up down | Direction of view | Field of view | Depth of field |
|--------|--------------|----------------------|-------------------|---------------|----------------|
| 300 mm | 16.000 Pixel | 160° 160° | 0° | 85° | 1 - 50 mm |

CH-154-00 Ø 3,4 mm

One hand control, 2-side angulation, length of angulated tip 25 mm

| Length | Fibre bundle | Angulation up down | Direction of view | Field of view | Depth of field |
|--------|--------------|----------------------|-------------------|---------------|----------------|
| 300 mm | 16.000 Pixel | 160° 160° | 0° | 85° | 1 - 50 mm |

Flexible Naso-Pharyngo-/ Laryngofibrescope with Instrument Channel



Accessoires:
- Leakage tester
- ETO-Cap

CH-156-00 Ø 3,8 mm

One hand control, 2-side angulation, length of angulated tip 20 mm, **instrument channel Ø 1.4 mm**

| Length | Fibre bundle | Angulation up down | Direction of view | Field of view | Depth of field |
|--------|--------------|----------------------|-------------------|---------------|----------------|
| 300 mm | 14.000 Pixel | 160° 160° | 0° | 85° | 3 - 50 mm |



Naso-Pharyngeal Forceps

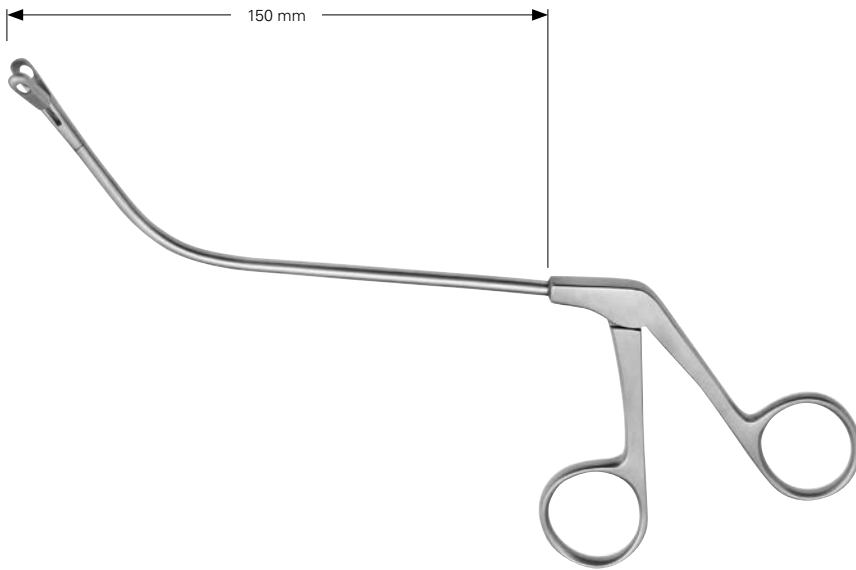

JATHO

CH-193-24 24,0 cm, 9 ½"

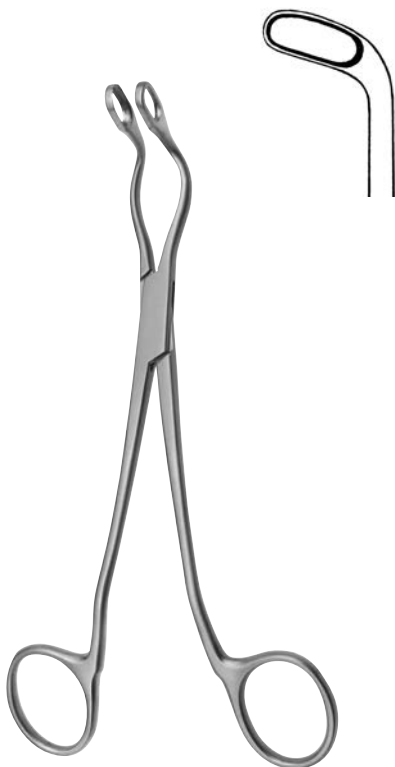

JURASZ

CH-195-01 19,0 cm, 7 ½"

For children

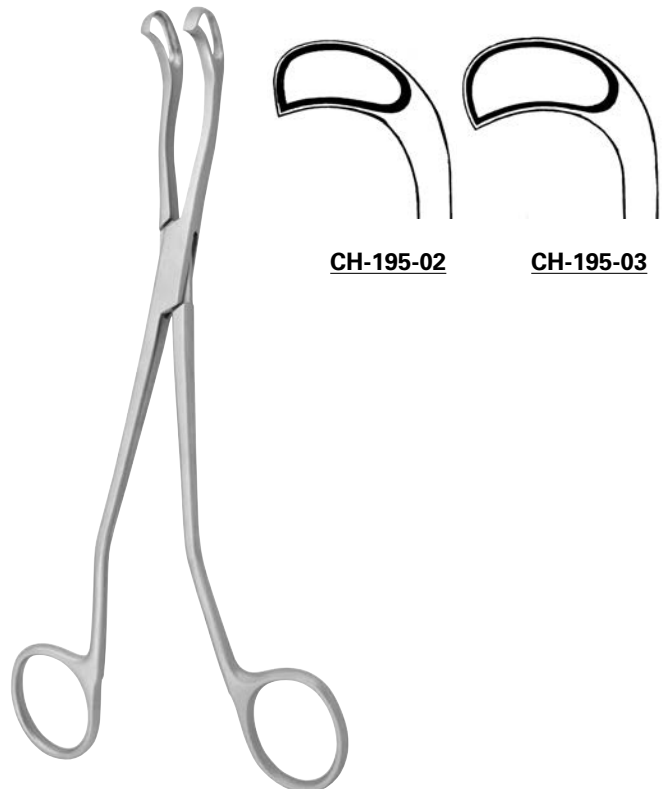

JURASZ

CH-195-02 - CH-195-03 21,0 cm, 8 ¼"

Adenoid Curettes

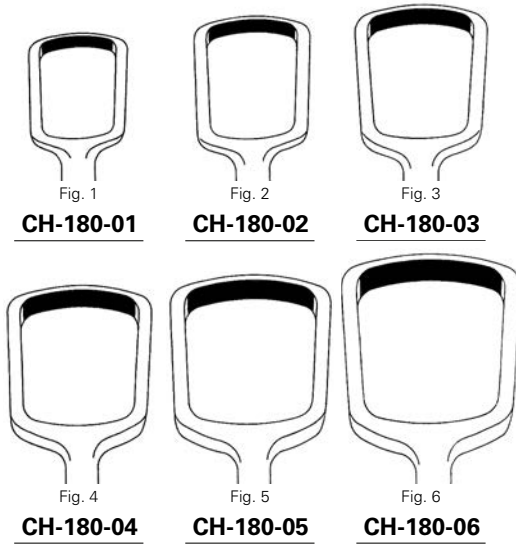

BECKMANN

CH-180-01 - CH-180-06 22,5 cm, 9"

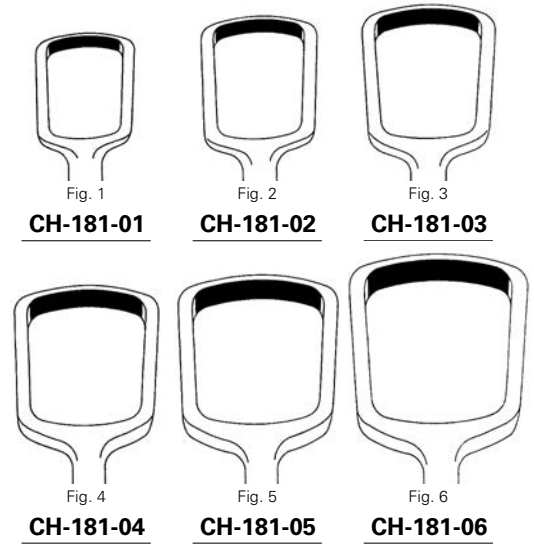

BECKMANN

CH-181-01 - CH-181-06 22,5 cm, 9"

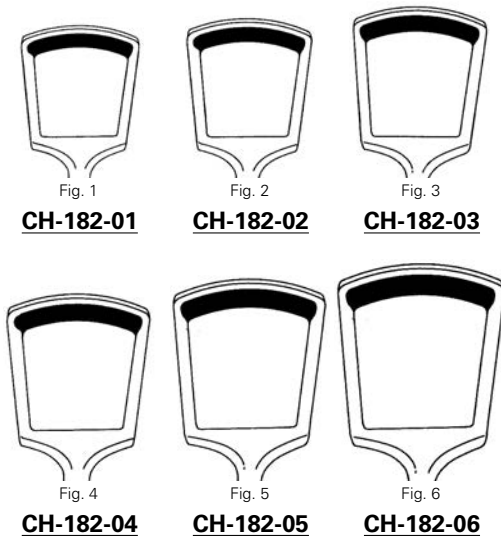

BECKMANN

CH-182-01 - CH-182-06 22,5 cm, 9"

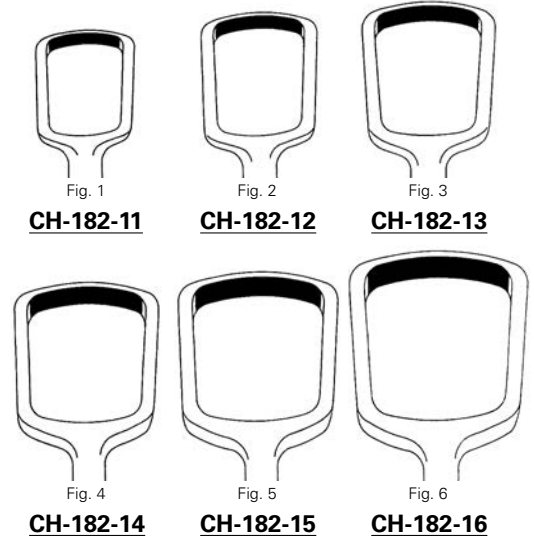

With basket

BECKMANN

CH-182-11 - CH-182-16 22,5 cm, 9"

Adenoid Curettes

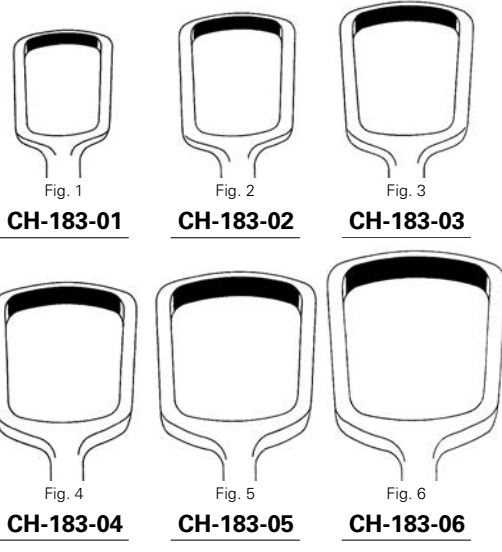

NEGUS

CH-183-01 - CH-183-06 22,5 cm, 9 "



BARNHILL

CH-184-01 - CH-184-04 20,0 cm, 8 "

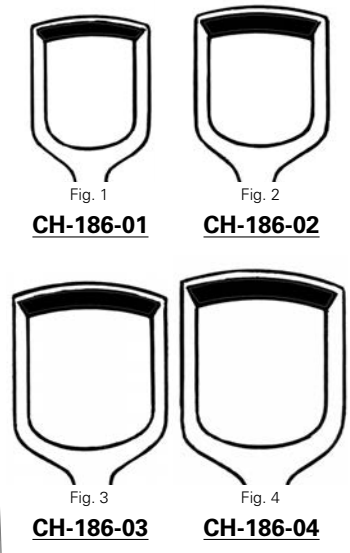

With basket

ST. CLAIR-THOMSON

CH-186-01 - CH-186-04 21,0 cm, 8 ¼ "

Adenotomes

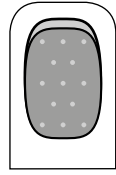

Fig. 1

CH-187-01

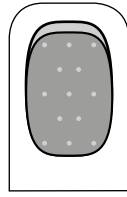

Fig. 2

CH-187-02

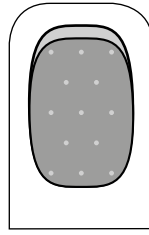

Fig. 3

CH-187-03

CH-187-11 Fig. 1 | 12 mm

CH-187-12 Fig. 2 | 16 mm

CH-187-13 Fig. 3 | 18 mm

Spare Blades, perforated

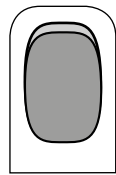

Fig. 1

CH-187-04

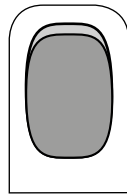

Fig. 2

CH-187-05

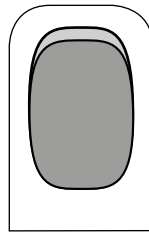

Fig. 3

CH-187-06

CH-187-14 Fig. 1 | 12 mm

CH-187-15 Fig. 2 | 16 mm

CH-187-16 Fig. 3 | 18 mm

Spare Blades, non perforated

LA FORCE

CH-187-01 - CH-187-06 23,0 cm, 9"

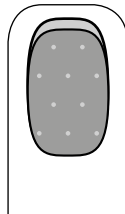

Fig. 1

CH-188-01

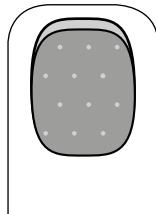

Fig. 2

CH-188-02

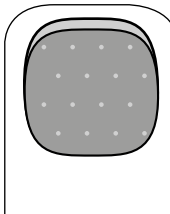

Fig. 3

CH-188-03

CH-188-11 Fig. 1 | 13 mm

CH-188-12 Fig. 2 | 16 mm

CH-188-13 Fig. 3 | 18 mm

Spare Blades, non perforated

SHAMBOUGH

CH-188-00 - CH-188-03 23,0 cm, 9"

Powder Blowers



CH-036-13 130 mm



CH-036-11 110 mm



CH-036-08 80 mm

KABIERSKE

CH-036-00 SET

Complete, consisting of:

| | |
|------------------------|------------------|
| 1 Valve rubber bulb | CH-036-50 |
| 1 Bottle | CH-036-01 |
| 1 Ear cannula, 80 mm 1 | CH-036-08 |
| Ear cannula, 110 mm 1 | CH-036-11 |
| Ear cannula, 130 mm 1 | CH-036-13 |
| Atomizer | CH-036-40 |

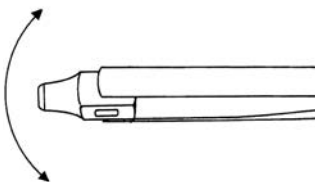

UNIVERSAL

CH-039-00

For Rhinology

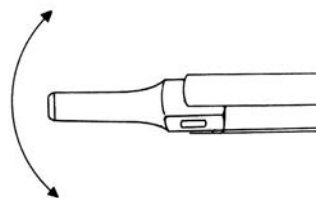

UNIVERSAL

CH-040-00

For Otolaryngology

Tongue Spatulas



CH-000-14 14,5 cm, 5 3/4"



CH-002-14 14,0 cm, 5 1/2"

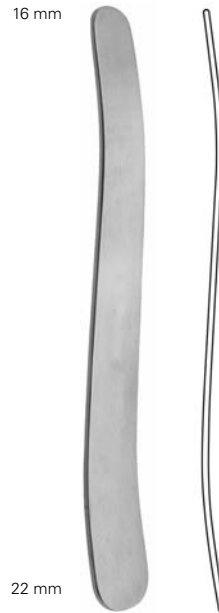

MAYO

CH-004-16 17,0 cm, 6 3/4"



BUCHWALD

CH-004-18 18,0 cm, 7"



BRUENINGS

CH-006-19 19,0 cm, 7 1/2"



FRENZEL

CH-007-16 16,5 cm, 6 1/2"



FRENZEL

CH-008-14 14,5 cm, 5 3/4"

Tongue Depressors



LACK

CH-009-13 13,0 mm

CH-009-19 19,0 mm

CH-009-22 22,0 mm

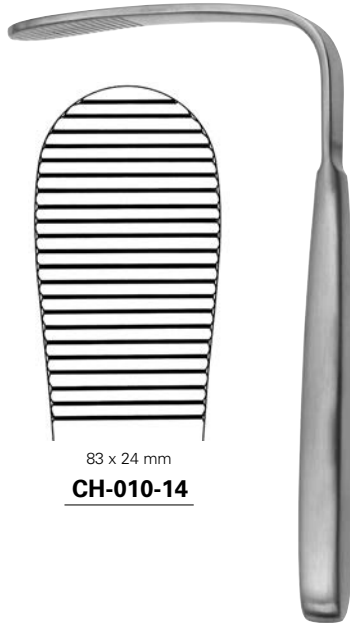

TOBOLD

CH-010-14 14,0 cm, 5 ½"

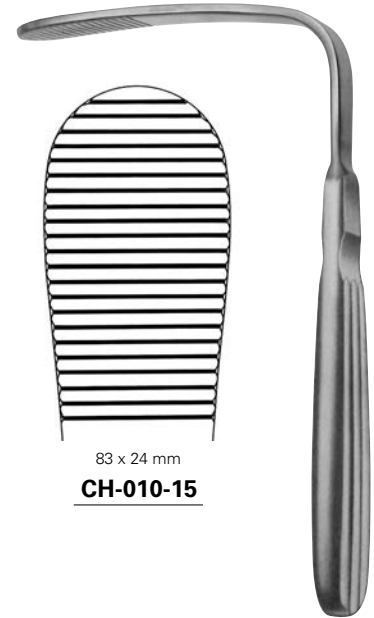

TOBOLD

CH-010-15 14,0 cm, 5 ½"

21 mm



MORITZ-SCHMIDT

CH-010-19 19,0 cm, 7 ½"

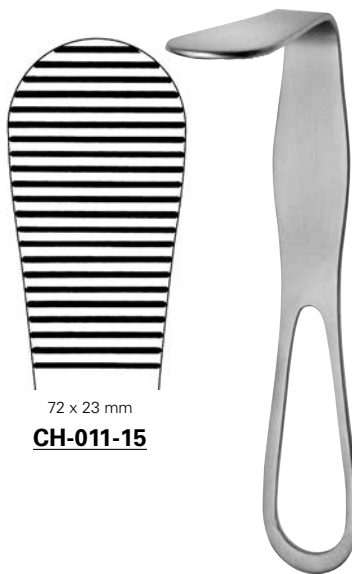

HARTMANN

CH-011-15 15,0 cm, 6"

Tongue Depressors

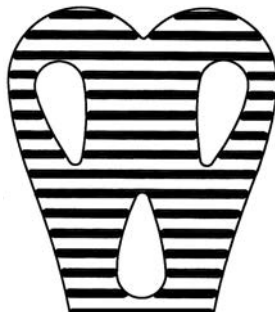

30 x 90 mm

CH-017-01



35 x 90 mm

CH-017-02

WIEDER

CH-017-01 - CH-017-02 14,5 cm, 5 ¾"

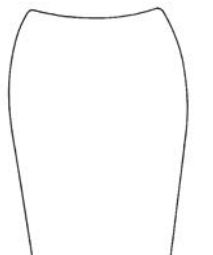

22 mm

CH-018-13

29 mm

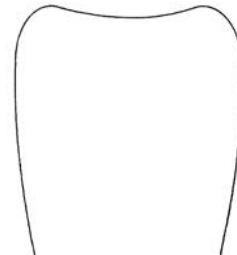

30 mm

CH-018-16

33 mm

DOYEN

CH-018-13 13,0 cm, 5 ⅛"

CH-018-16 16,0 cm, 6 ¼"

Mouth Gags



HEISTER

CH-022-13 13,0 cm, 5"



MOLT

CH-023-10 10,0 cm, 4"



DOYEN-COLLIN

CH-025-12 12,0 cm, 4 ¾"

CH-028-99

Spare jaws



DOYEN-JANSEN

CH-026-14 14,0 cm, 5 ½"



FERGUSSON-ACKLAND

CH-027-14 14,5 cm, 5 ¾"



DENHARDT

CH-028-12 12,5 cm, 5"

Mouth Gags

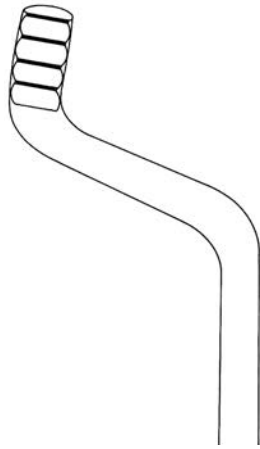

CH-029-16

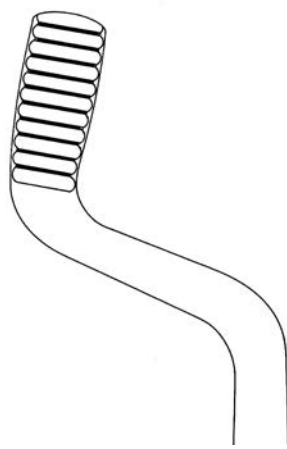

CH-029-19

ROSER-KOENIG“

CH-029-16 16,0 cm, 6 ¼”

CH-029-19 19,0 cm, 7 ½”

Without tongue depressor

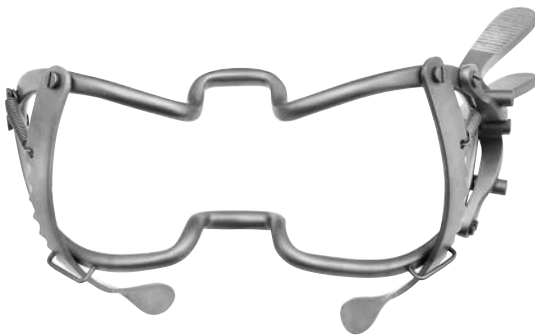

With tongue depressor

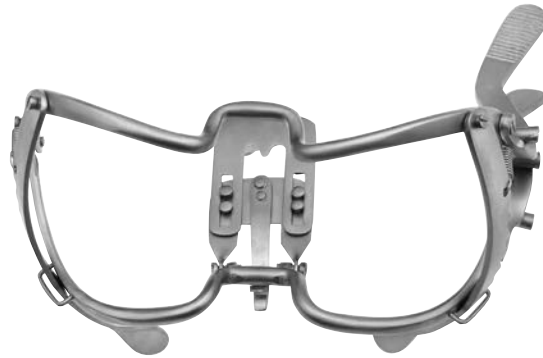

WHITEHEAD

26-031-09 9,0 cm, 3 ½”

26-031-11 11,0 cm, 4 ¾”

26-031-13 13,0 cm, 5 ⅛”

26-031-15 15,0 cm, 5 ⅞”

WHITEHEAD

26-032-11 11,0 cm, 4 ¾”

26-032-13 13,0 cm, 5 ⅛”

26-032-15 15,0 cm, 5 ⅞”

Mouth Gags



Without tongue depressor

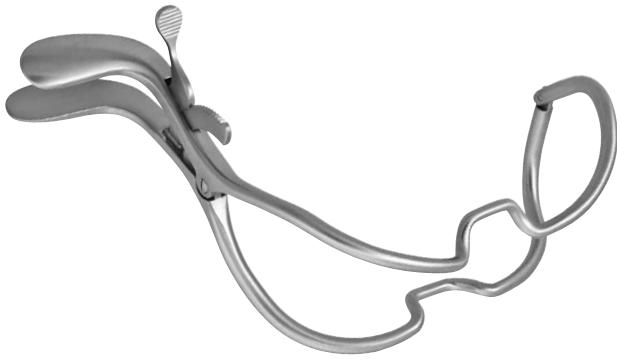

AMNOTEC-JENNINGS

| | |
|------------------|-----------------|
| CH-033-01 | 9,0 cm, 3 1/2" |
| CH-033-02 | 11,0 cm, 4 3/8" |
| CH-033-03 | 13,0 cm, 5 1/8" |
| CH-033-04 | 15,0 cm, 5 7/8" |

Without tongue depressor

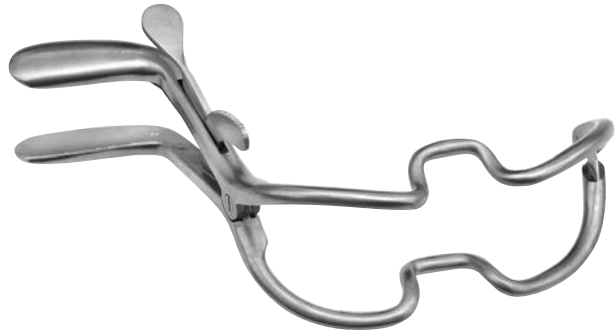

JENNINGS

| | |
|------------------|-----------------|
| CH-033-09 | 9,0 cm, 3 1/2" |
| CH-033-11 | 11,0 cm, 4 3/8" |
| CH-033-13 | 13,0 cm, 5 1/8" |
| CH-033-15 | 15,0 cm, 5 7/8" |

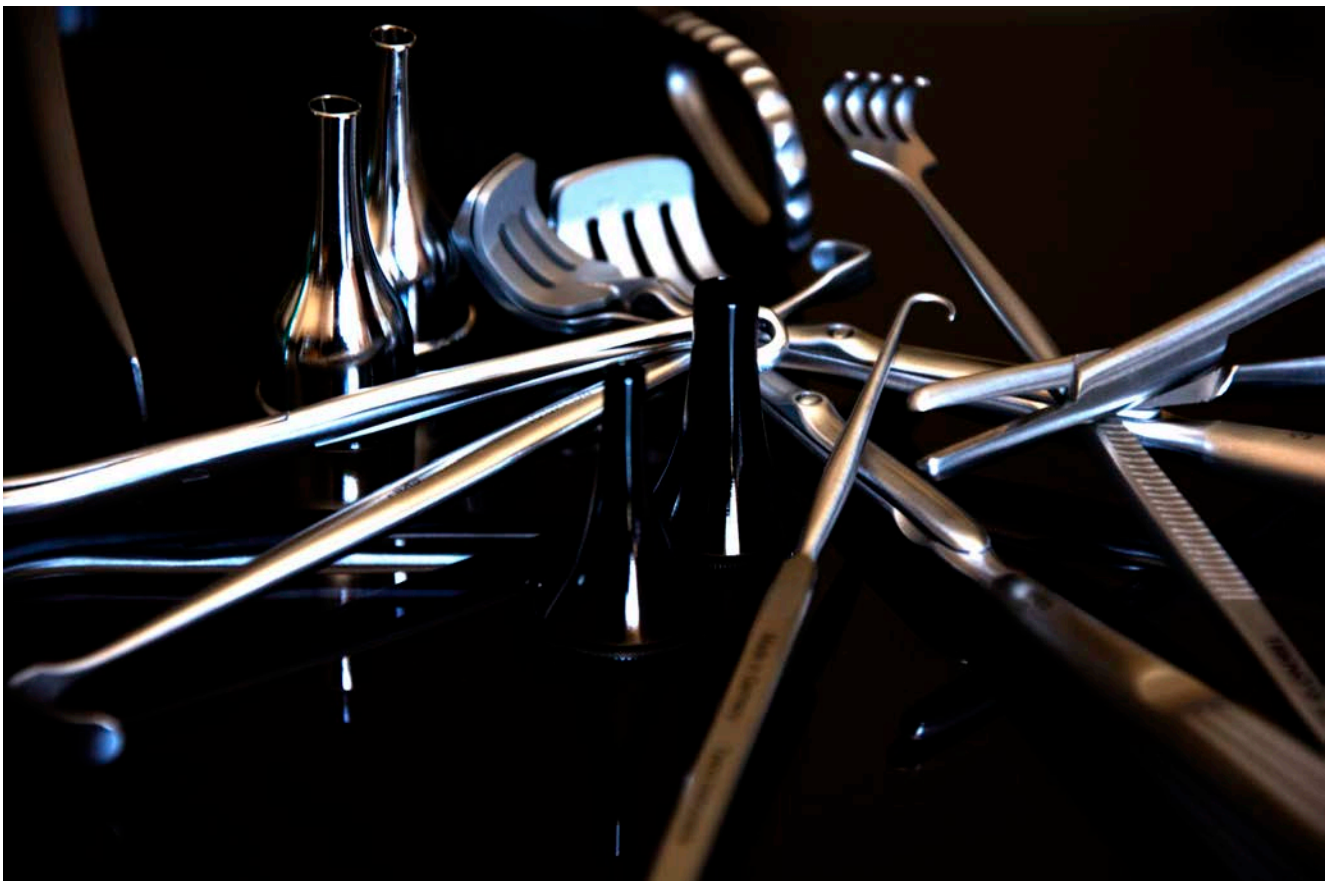

Mouth Gags

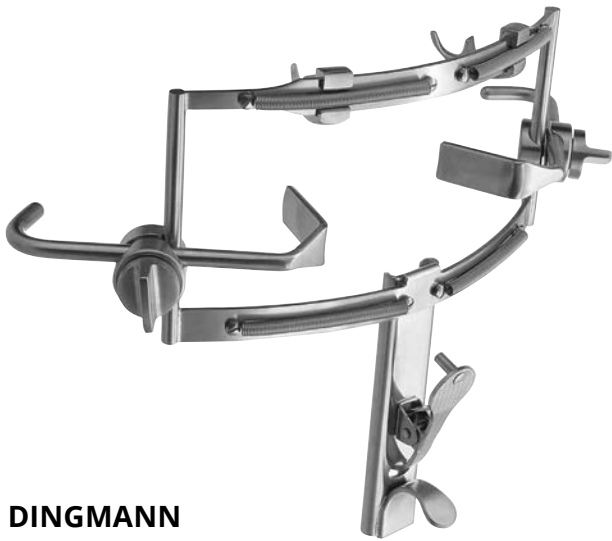

Frame, with 2 adjustable lateral valves

DINGMANN

CH-035-00 SET

Complete, consisting of:

| | |
|----------------------------|------------------|
| 1 Frame | CH-035-04 |
| 1 Tounge depressor, Fig. 1 | CH-035-01 |
| 1 Tounge depressor, Fig. 2 | CH-035-02 |
| 1 Tounge depressor, Fig. 3 | CH-035-03 |



CH-035-01

65 x 25 mm



CH-035-02

70 x 29 mm



CH-035-03

80 x 32 mm

Mouth Gags



DAVIS-MEYER
CH-040-00

Left



DAVIS-MEYER
CH-040-03

Right

Palate plate left



DAVIS-MEYER
CH-040-02

Palate plate right



DAVIS-MEYER
CH-040-04

Spare silicone inserts



DAVIS-MEYER
CH-040-01



DAVIS-MEYER

| | |
|------------------|-------------|
| CH-053-01 | 70 x 29 mm |
| CH-053-02 | 75 x 30 mm |
| CH-053-03 | 80 x 31 mm |
| CH-053-04 | 85 x 32 mm |
| CH-053-05 | 95 x 33 mm |
| CH-053-06 | 100 x 33 mm |
| CH-053-07 | 105 x 34 mm |

Mouth Gags

SKILL
Surge Instrument

DAVIS-BOYLE

CH-040-90 SET

Complete, consisting of:

| | |
|----------------------------|------------------|
| 1 Frame | CH-041-00 |
| 1 Tounge depressor, Fig. 1 | CH-055-01 |
| 1 Tounge depressor, Fig. 2 | CH-055-02 |
| 1 Tounge depressor, Fig. 3 | CH-055-03 |
| 1 Tounge depressor, Fig. 4 | CH-055-04 |
| 1 Tounge depressor, Fig. 5 | CH-055-05 |

CH-055-01

25 x 19 mm

CH-055-02

62 x 25 mm

CH-055-03

75 x 25 mm

CH-055-04

92 x 25 mm

CH-055-05

108 x 25 mm

Mouth Gags



DAVIS-BOYLE

CH-040-91 SET

Complete, consisting of:

| | |
|----------------------------|------------------|
| 1 Frame | CH-041-00 |
| 1 Tongue depressor, Fig. 1 | CH-055-01 |
| 1 Tongue depressor, Fig. 2 | CH-056-02 |
| 1 Tongue depressor, Fig. 3 | CH-056-03 |
| 1 Tongue depressor, Fig. 4 | CH-056-04 |
| 1 Tongue depressor, Fig. 5 | CH-056-05 |



CH-055-01

25 x 19 mm



CH-056-02

62 x 25 mm



CH-056-03

75 x 25 mm



CH-056-04

92 x 25 mm



CH-056-05

108 x 25 mm

Mouth Gags



DAVIS-BOYLE

CH-040-92 SET

Complete, consisting of:

| | |
|----------------------------|------------------|
| 1 Frame | CH-041-02 |
| 1 Tounge depressor, Fig. 1 | CH-055-01 |
| 1 Tounge depressor, Fig. 2 | CH-055-02 |
| 1 Tounge depressor, Fig. 3 | CH-055-03 |
| 1 Tounge depressor, Fig. 4 | CH-055-04 |
| 1 Tounge depressor, Fig. 5 | CH-055-05 |



CH-055-01

25 x 19 mm



CH-055-02

62 x 25 mm



CH-055-03

75 x 25 mm



CH-055-04

92 x 25 mm



CH-055-05

108 x 25 mm

Mouth Gags



DAVIS-BOYLE

CH-040-93 SET

Complete, consisting of:

| | |
|----------------------------|------------------|
| 1 Frame | CH-041-02 |
| 1 Tongue depressor, Fig. 1 | CH-055-01 |
| 1 Tongue depressor, Fig. 2 | CH-056-02 |
| 1 Tongue depressor, Fig. 3 | CH-056-03 |
| 1 Tongue depressor, Fig. 4 | CH-056-04 |
| 1 Tongue depressor, Fig. 5 | CH-056-05 |



CH-055-01

25 x 19 mm



CH-056-02

62 x 25 mm



CH-056-03

75 x 25 mm



CH-056-04

92 x 25 mm



CH-056-05

108 x 25 mm

Mouth Gags



Rotatable



DAVIS-BOYLE
CH-041-01

For children



DAVIS-BOYLE
CH-042-00

For children



DAVIS-BOYLE
CH-042-02

For teenager



DAVIS-BOYLE
CH-043-00

For teenager



DAVIS-BOYLE
CH-043-01

Mouth Gags



KILNER-DOUGHTY

CH-044-00 SET

Complete, consisting of:

| | |
|----------------------------|------------------|
| 1 Frame | CH-044-19 |
| 1 Tounge depressor, Fig. 1 | CH-050-01 |
| 1 Tounge depressor, Fig. 2 | CH-050-02 |
| 1 Tounge depressor, Fig. 3 | CH-050-03 |
| 1 Gaumenplatte | CH-044-02 |



CH-050-01

65 x 28 mm



CH-050-02

75 x 32 mm



CH-050-03

80 x 37 mm



CH-044-02

Mouth Gags



MC IVOR

Complete, consisting of:

| | |
|----------------------------|------------------|
| 1 Frame | CH-045-00 |
| 1 Tongue depressor, Fig. 1 | CH-054-01 |
| 1 Tongue depressor, Fig. 2 | CH-054-02 |
| 1 Tongue depressor, Fig. 3 | CH-054-03 |



CH-054-01

70 x 23 mm



CH-054-02

86 x 25 mm



CH-054-03

100 x 26 mm

Tongue Depressors



DINGMANN

| | |
|------------------|------------|
| CH-035-01 | 65 x 25 mm |
| CH-035-02 | 70 x 29 mm |
| CH-035-03 | 80 x 32 mm |

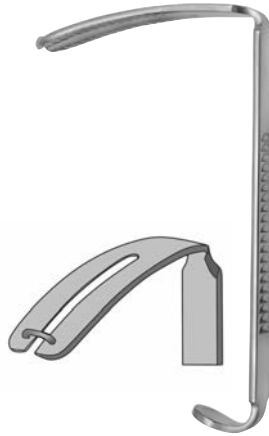

DOUGHTY

| | |
|------------------|--------|
| CH-048-01 | 65 mm |
| CH-048-02 | 75 mm |
| CH-048-03 | 90 mm |
| CH-048-04 | 102 mm |
| CH-048-05 | 115 mm |



| | |
|------------------|--------|
| CH-049-01 | 65 mm |
| CH-049-02 | 75 mm |
| CH-049-03 | 90 mm |
| CH-049-04 | 102 mm |



RUSSEL-DAVIS

| | |
|------------------|-------------|
| CH-050-01 | 65 x 28 mm |
| CH-050-02 | 75 x 32 mm |
| CH-050-03 | 80 x 37 mm |
| CH-050-04 | 94 x 41 mm |
| CH-050-05 | 103 x 46 mm |



RUSSEL-DAVIS

| | |
|------------------|------------|
| CH-051-01 | 57 x 18 mm |
| CH-051-02 | 67 x 22 mm |
| CH-051-03 | 75 x 25 mm |



GAST

| | |
|------------------|-------------|
| CH-052-01 | 64 x 28 mm |
| CH-052-02 | 74 x 34 mm |
| CH-052-03 | 87 x 38 mm |
| CH-052-04 | 95 x 40 mm |
| CH-052-05 | 103 x 45 mm |

Tongue Depressors



DAVIS-MEYER

| | |
|------------------|-------------|
| CH-053-01 | 70 x 29 mm |
| CH-053-02 | 75 x 30 mm |
| CH-053-03 | 80 x 31 mm |
| CH-053-04 | 85 x 32 mm |
| CH-053-05 | 95 x 33 mm |
| CH-053-06 | 100 x 33 mm |
| CH-053-07 | 105 x 34 mm |

MC IVOR

| | |
|------------------|-------------|
| CH-054-01 | 70 x 23 mm |
| CH-054-02 | 86 x 25 mm |
| CH-054-03 | 100 x 26 mm |

MC IVOR

| | |
|------------------|-------------|
| CH-054-11 | 70 x 23 mm |
| CH-054-12 | 86 x 25 mm |
| CH-054-13 | 100 x 26 mm |

DAVIS-BOYLE

| | |
|------------------|-------------|
| CH-055-02 | 65 x 22 mm |
| CH-055-03 | 75 x 25 mm |
| CH-055-04 | 92 x 25 mm |
| CH-055-05 | 108 x 25 mm |

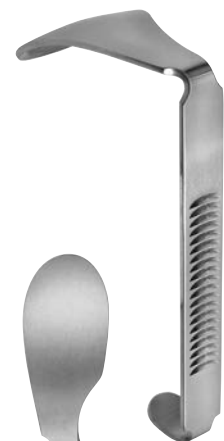

DAVIS-BOYLE

| | |
|------------------|-------------|
| CH-055-01 | 25 x 19 mm |
| CH-056-02 | 65 x 25 mm |
| CH-056-03 | 75 x 25 mm |
| CH-056-04 | 92 x 25 mm |
| CH-056-05 | 108 x 25 mm |

WUERZBURG

| | |
|------------------|-------------|
| CH-057-01 | 66 x 28 mm |
| CH-057-02 | 75 x 32 mm |
| CH-057-03 | 83 x 34 mm |
| CH-057-04 | 93 x 37 mm |
| CH-057-05 | 100 x 38 mm |

RING

| | |
|------------------|------------|
| CH-058-02 | 58 x 23 mm |
| CH-058-03 | 72 x 27 mm |
| CH-058-04 | 87 x 34 mm |
| CH-058-05 | 95 x 37 mm |

HERBERHOLD

| | |
|------------------|-------------|
| CH-059-01 | 75 x 32 mm |
| CH-059-02 | 83 x 34 mm |
| CH-059-03 | 93 x 37 mm |
| CH-059-04 | 100 x 38 mm |

Chest Support, Holding Drame for Mouth Gags



Chest support for all mouth gags



Band to fix the NEGUS chest support



NEGUS

| | |
|------------------|--------|
| CH-060-00 | 140 mm |
| CH-060-01 | 110 mm |
| CH-060-02 | 85 mm |

NEGUS

| |
|------------------|
| CH-060-05 |
|------------------|

Holding frame for mouth gags

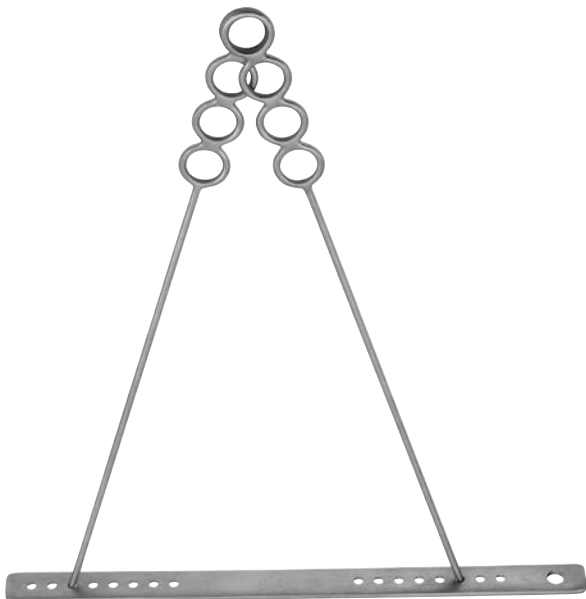

DRAFFIN

| |
|------------------|
| CH-060-92 |
|------------------|

Tonsil Grasping Forceps

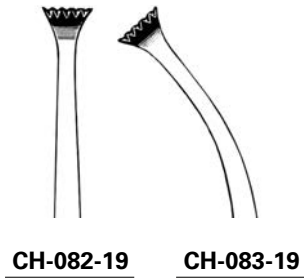

CH-082-19 **CH-083-19**

CLOVER

CH-082-19 - CH-083-19 19,0 cm, 7 ½"



CH-085-18
CH-085-23

WHITE

CH-085-18 18,0 cm, 7"
CH-085-23 23,0 cm, 9"

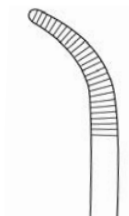

CH-087-18

SAWTELL

CH-087-18 19,0 cm, 7 ½"

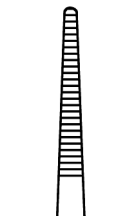

CH-088-19

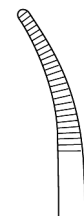

CH-089-19

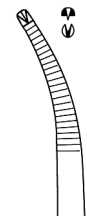

CH-091-19

SCHNIDT

CH-088-19 - CH-091-19 19,5 cm, 7 ¾"

Tonsil Grasping Forceps

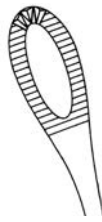

CH-093-20

BLOHMKE

CH-093-20 20,0 cm, 8"

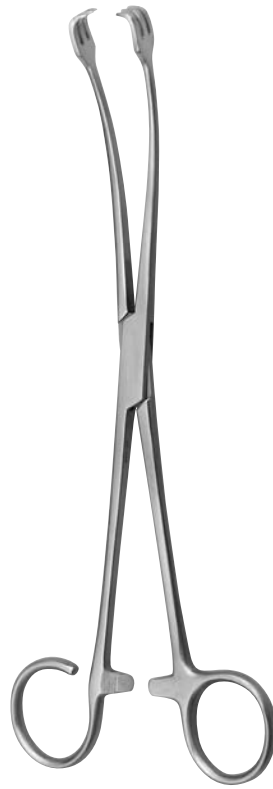

BALLENGER

CH-094-21 21,5 cm, 8 1/2"



MARSCHIK-KRONE

CH-095-20 20,0 cm, 8"



MARSCHIK

CH-096-22 22,0 cm, 8 3/4"

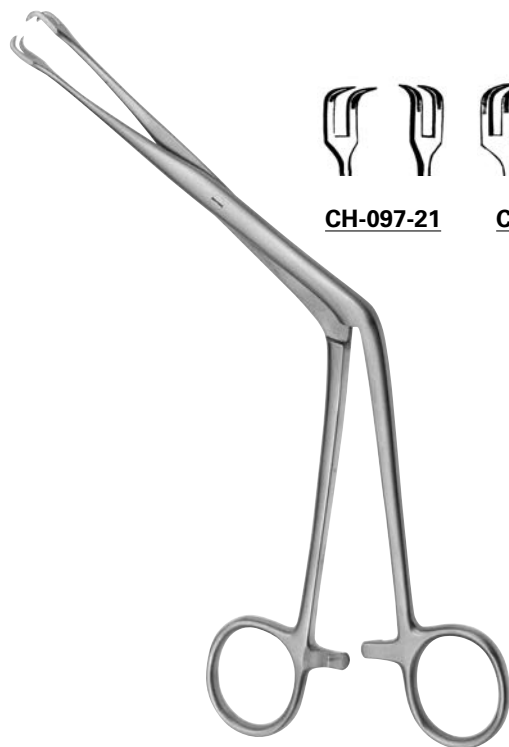

CH-097-21



CH-097-22

TYDING-TIVNEN

CH-097-21 - CH-097-22 21,0 cm, 8 1/4"



ABRAHAM

CH-098-20 20,5 cm, 8"

Tonsil Dissectors



With suction device

LOPEZ-REINKE

CH-099-23 23,5 cm, 9 1/4"

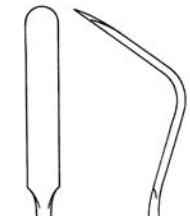

CH-100-01

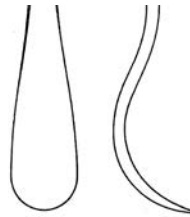

Tonsil knife and enucleator

CARPENTER

CH-100-01 25,0 cm, 9 3/4"

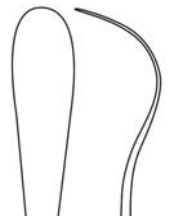

CH-100-02

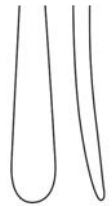

CARPENTER

CH-100-02 24,0 cm, 9 1/2"



12 mm

CH-101-01

6 mm



14 mm

CH-101-02

10 mm



14 mm

CH-101-03

9 mm



HURD

CH-101-01 - CH-101-03 21,5 cm, 8 1/2"



12 mm

CH-102-01

9 mm



17 mm

CH-102-02

9 mm



HENKE

CH-102-01 - CH-102-02 23,5 cm, 9 1/4"

Tonsil Knives, Tonsil Snares



CH-103-06 6,0 mm
CH-103-08 8,0 mm



With protection shield



GWYNE-EVANS

MOLLISON

FISCHER

CH-103-06 - CH-103-08 20,0 cm, 8 " **CH-105-98** 21,0 cm, 8½ " **CH-104-18** 18,0 cm, 7 " **CH-109-20** 20,5 cm, 8 "



Tonsil abscess forceps



Without ratchet



With ratchet



With ratchet

THILENIUS

EVES

EVES

BRUENINGS

CH-110-19 19,0 cm, 7 ½ " **CH-150-26** 28,0 cm, 11 " **CH-152-25** 28,0 cm, 11 " **CH-154-27** 27,0 cm, 10¾ "

Tonsil Snares

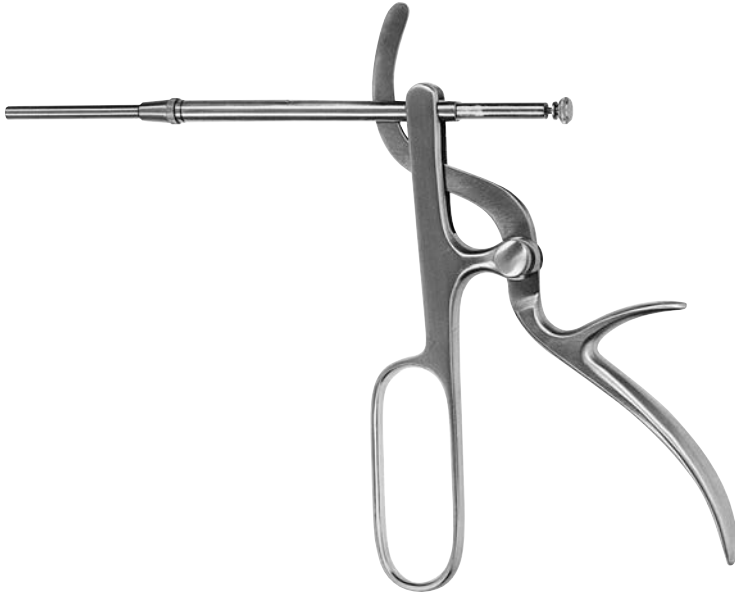

TYDING
CH-155-00



TYDING
CH-155-01

Straight tip only



VEEDER
CH-155-02

Tip only

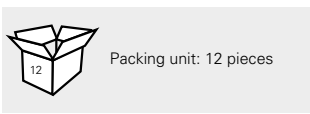

Packing unit: 12 pieces

Snare wires

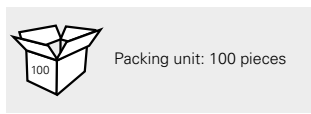

Packing unit: 100 pieces

Snare wires

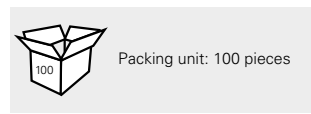

Packing unit: 100 pieces

Wire loops

Snare wires, coil of 10 m



CH-156-03 Ø 0,3 mm
CH-156-05 Ø 0,5 mm



CH-156-13 Ø 0,3 mm
CH-156-14 Ø 0,4 mm
CH-156-15 Ø 0,5 mm



CH-157-04 Ø 0,4 | 40 mm
CH-157-05 Ø 0,4 | 50 mm



CH-158-02 Ø 0,2 mm
CH-158-03 Ø 0,3 mm
CH-158-04 Ø 0,4 mm

Tonsil Lectomes



SLUDER-BALLENGER

CH-159-00 SET

Complete, consisting of:

| | |
|---------------|------------------|
| 1 Handle | CH-159-04 |
| 1 Tip, Fig. 1 | CH-159-01 |
| 1 Tip, Fig. 2 | CH-159-02 |
| 1 Tip, Fig. 3 | CH-159-03 |

Blade

Blade

Blade

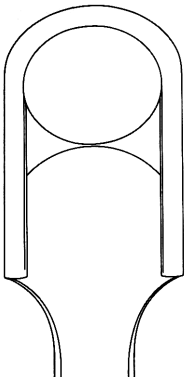

CH-159-01

Fig. 1

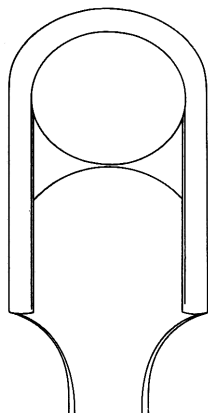

CH-159-02

Fig. 2

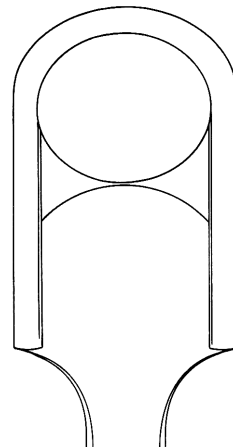

CH-159-03

Fig. 3

Tonsil Instruments

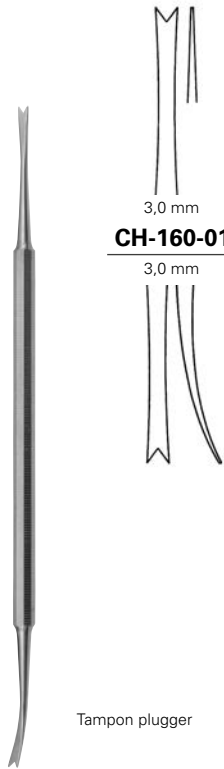

CH-160-01
3,0 mm

Tampon plugger

LUNIATSCHEK

CH-160-01 17,5 cm, 7 "

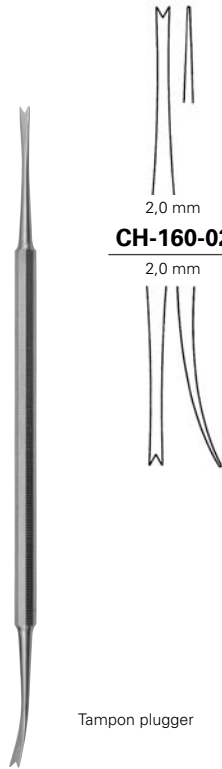

CH-160-02
2,0 mm

Tampon plugger

LUNIATSCHEK

CH-160-02 17,5 cm, 7 "



CH-163-21
For left hand

Left palate needle

HURD

CH-163-21 21,0 cm, 8 ¼ "



CH-165-21
For right hand

Left palate needle

HURD

CH-165-21 21,0 cm, 8 ¼ "



CH-167-25

Tonsil needle

CLAUS V. EICKEN

CH-167-25 25,0 cm, 9 ¾ "

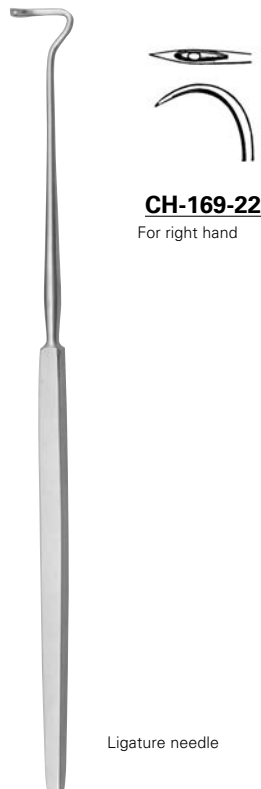

CH-169-22
For right hand

Ligature needle

DUPUY-WEISS

CH-169-22 22,0 cm, 8 "



CH-171-22
For left hand

Ligature needle

DUPUY-WEISS

CH-171-22 22,0 cm, 8 "

Tonsil Instruments



Ligature instrument

ROEDER

CH-172-26 26,5 cm, 10 1/2 "

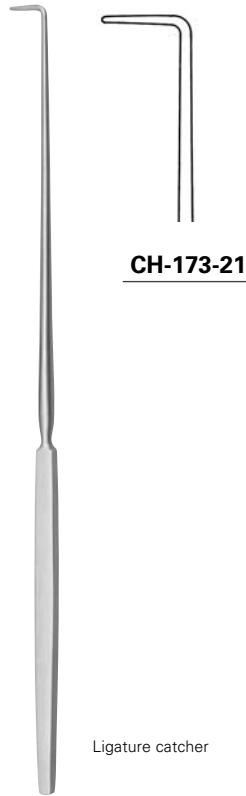

Ligature catcher

HOEN V. EICKEN

CH-173-21 21,0 cm, 8 1/4 "

Soft palate retractor



HASLINGER

CH-174-00 17,0 cm, 6 3/4 "

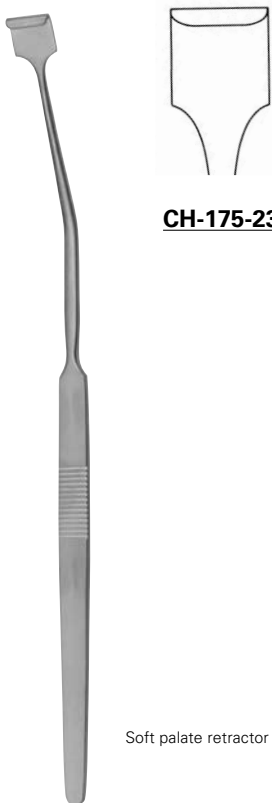

Soft palate retractor

NAGER

CH-175-23 24,0 cm, 9 1/2 "

CH-175-23



CH-176-18 18 mm
CH-176-20 20 mm
CH-176-22 22 mm

LOVE

CH-176-18 - CH-176-22 15,0 cm, 6 "

Trigeminal Knives, Tonsil Knives



Trigeminal knife

OLIVECRONA

CH-369-20 20,5 cm, 8"



Tonsil knife

FOWLER

CH-371-20 20,0 cm, 8"



Tonsil knife

ABRAHAM

CH-371-21 21,5 cm, 8 1/2"



Tonsil knife

BRUENINGS

CH-371-22 21,5 cm, 8 1/2"

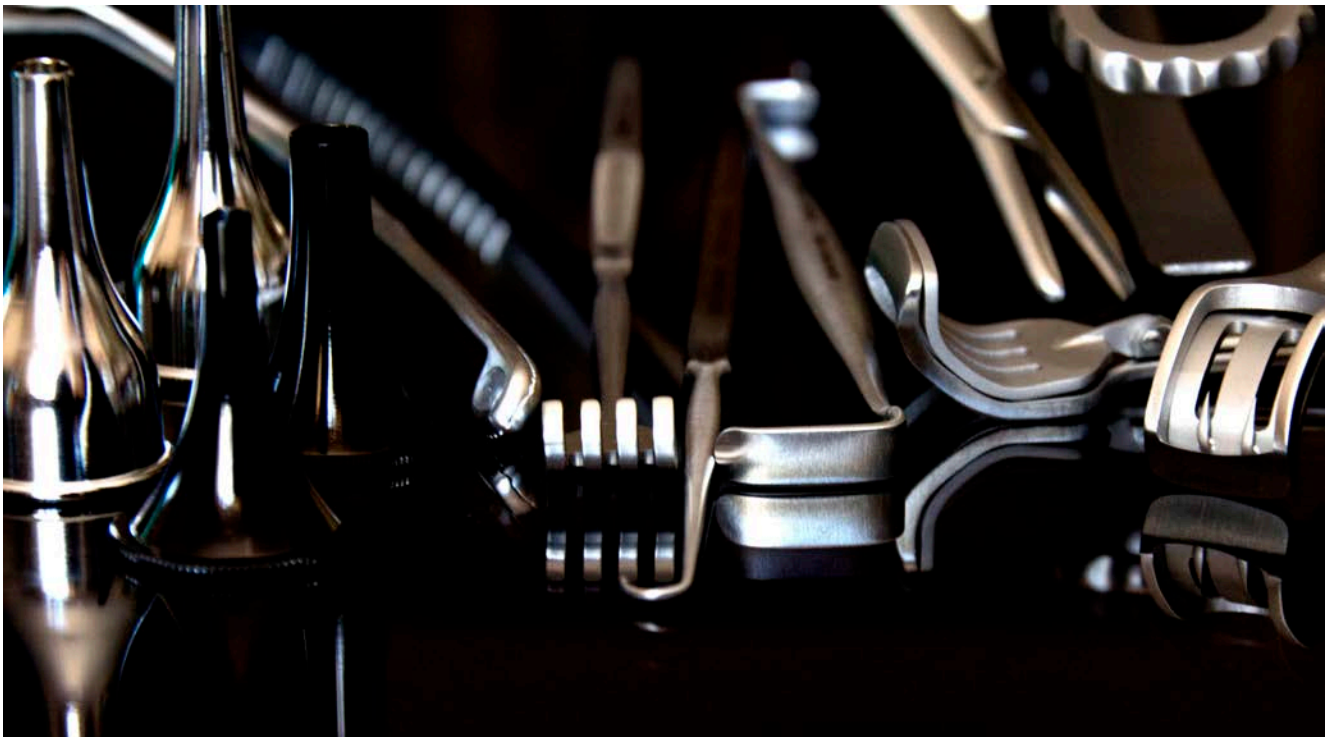

Suction Tubes



YANKAUER
CH-911-01 27,0 cm, 10³/₄ "



YANKAUER
CH-911-02 27,0 cm, 10³/₄ "



YANKAUER
CH-911-31



BABY-YANKAUER
CH-911-32



BABY-YANKAUER
CH-911-03 21,0 cm, 8¹/₄ "



WALTON-YANKAUER
CH-911-04 33,0 cm, 13 "

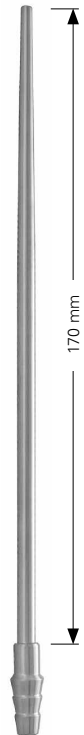

conical

CH-942-18 Ø 3,0 mm

Tonsil Scissors, Cartilage Scissors

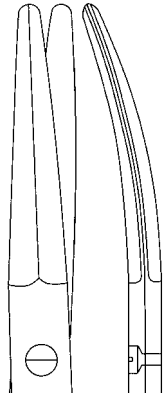
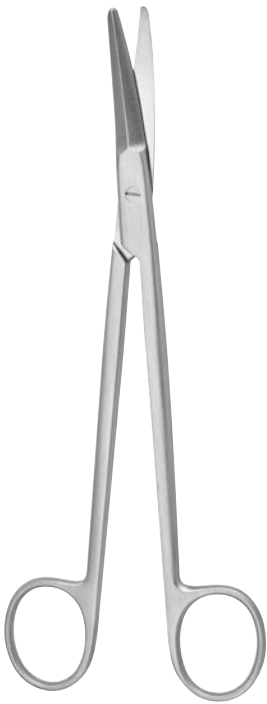

CH-301-18

Tonsil scissors

BOETTCHER

CH-301-18 18,0 cm, 7"

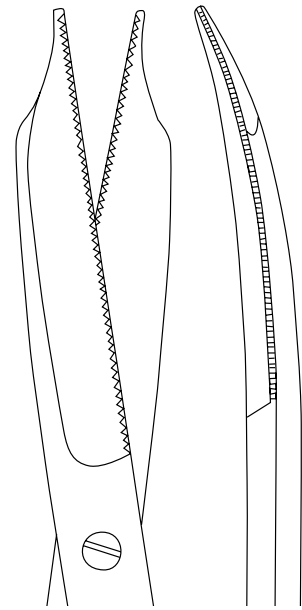
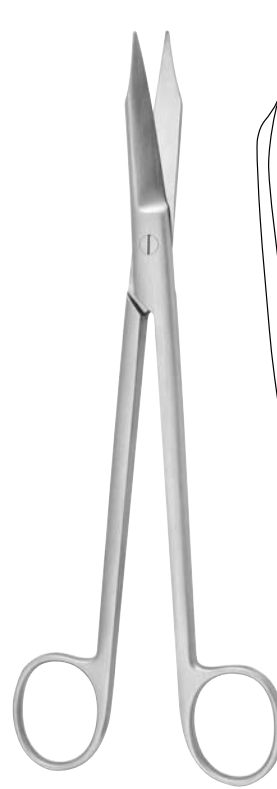

CH-301-20

Cartilage scissors

MARTIN

CH-301-20 20,0 cm, 8"

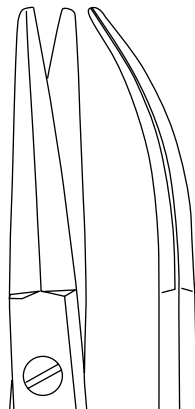
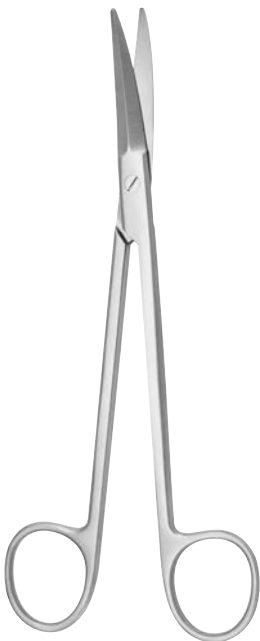

CH-303-17

Tonsil scissors

PRINCE

CH-303-17 17,0 cm, 6 3/4"

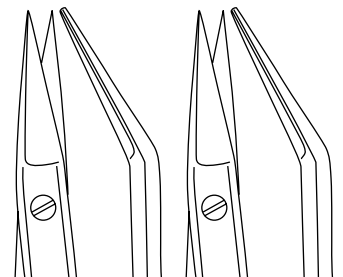

CH-305-17

CH-307-17

Tonsil scissors

DEAN

CH-305-17 - CH-307-17 17,0 cm, 6 3/4"

Tonsil Scissors, TC



CH-309-19

Tonsil scissors

GOOD

CH-309-19 19,0 cm, 7 ½"

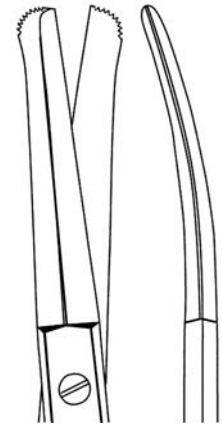
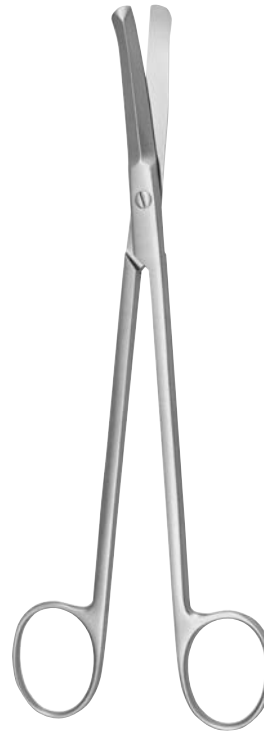

CH-311-19

Tonsil scissors

GOOD-SCHWEKENDIECK

CH-311-19 19,0 cm, 7 ½"

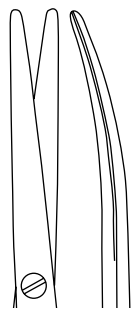
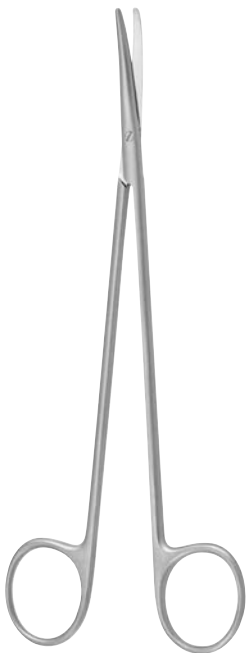

CH-253-17

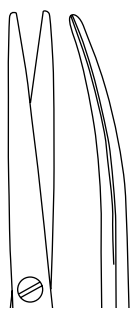

CH-255-17

Dissecting scissors

TOENNIS-ADSON

CH-253-17 - CH-255-17 17,5 cm, 7"

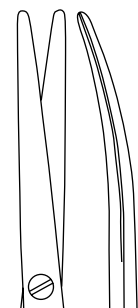
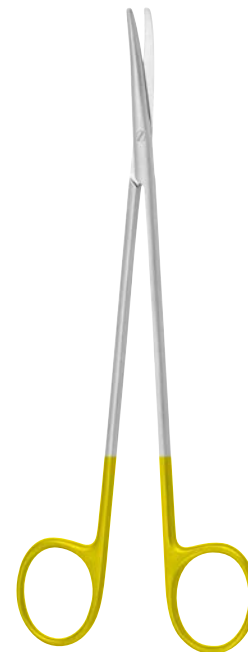

12-253-17

TOENNIS-ADSON

12-253-17 17,5 cm, 7"

Syringes, Tonsil Needles



Barrels for CH-848-02 - CH-848-20

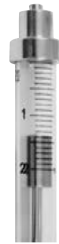

LUER

| | |
|------------------|---------|
| CH-840-01 | 1,0 ml |
| CH-840-02 | 2,0 ml |
| CH-840-05 | 5,0 ml |
| CH-840-10 | 10,0 ml |
| CH-840-20 | 20,0 ml |
| CH-840-50 | 50,0 ml |

LUER-LOCK

| | |
|------------------|---------|
| CH-844-01 | 1,0 ml |
| CH-844-02 | 2,0 ml |
| CH-844-05 | 5,0 ml |
| CH-844-10 | 10,0 ml |
| CH-844-20 | 20,0 ml |
| CH-844-50 | 50,0 ml |

LUER-LOCK

| | |
|------------------|---------|
| CH-848-02 | 2,0 ml |
| CH-848-05 | 5,0 ml |
| CH-848-10 | 10,0 ml |
| CH-848-20 | 20,0 ml |

LUER-LOCK

| | |
|------------------|---------|
| CH-849-02 | 2,0 ml |
| CH-849-05 | 5,0 ml |
| CH-849-10 | 10,0 ml |
| CH-849-20 | 20,0 ml |



CH-810-01 Ø 0,8 x 100 mm **CH-810-02** Ø 0,8 x 80 mm

Salivary Duct Probes



BOWMAN

| | |
|------------------|-----------|
| CH-609-00 | Fig. 00/0 |
| CH-609-01 | Fig. 00/0 |
| CH-609-02 | Fig. 1/2 |
| CH-609-03 | Fig. 3/4 |
| CH-609-04 | Fig. 5/6 |
| CH-609-05 | Fig. 7/8 |



| | |
|------------------|-----------------|
| CH-606-13 | 13,0 cm, 5 1/8" |
| CH-606-14 | 14,5 cm, 5 3/4" |
| CH-606-16 | 16,0 cm, 6 1/4" |
| CH-606-18 | 18,0 cm, 7" |
| CH-606-20 | 20,0 cm, 8" |



WILDER

| | |
|------------------------------|-------------|
| CH-610-02 - CH-610-04 | 10,0 cm, 4" |
|------------------------------|-------------|



Bipolar Forceps with Irrigation



Straight

Width of tips

Length

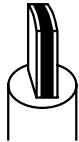

| | | |
|------------|--------|--------------------|
| 0,5 x 8 mm | 180 mm | CH-700-18 I |
| | 200 mm | CH-700-20 I |

| | | |
|------------|--------|--------------------|
| 1,0 x 8 mm | 180 mm | CH-710-18 I |
| | 200 mm | CH-710-20 I |

| | | |
|------------|--------|--------------------|
| 2,0 x 8 mm | 180 mm | CH-712-18 I |
| | 200 mm | CH-712-20 I |



Bayonet

Width of tips

Length

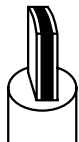

| | | |
|------------|--------|--------------------|
| 0,5 x 5 mm | 180 mm | CH-740-18 I |
| | 200 mm | CH-740-20 I |
| | 220 mm | CH-740-22 I |

| | | |
|------------|--------|--------------------|
| 1,0 x 5 mm | 180 mm | CH-750-18 I |
| | 200 mm | CH-750-20 I |
| | 220 mm | CH-750-22 I |

| | | |
|------------|--------|--------------------|
| 2,0 x 5 mm | 180 mm | CH-752-18 I |
| | 200 mm | CH-752-20 I |
| | 220 mm | CH-752-22 I |

Bipolar Forceps with Double Irrigation and Luer-Lock Connector



Width of tips

Length

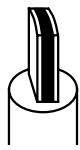

| | | |
|------------|--------|--------------------|
| 1,0 x 8 mm | 220 mm | CH-751-22 I |
| 1,5 x 8 mm | 220 mm | CH-753-22 I |



CH-751-90



Tubing set, sterile, single use



Order quantity: 40 pieces



Bipolar Forceps





Bipolar Forceps, straight, flat-plug, 500 Vp

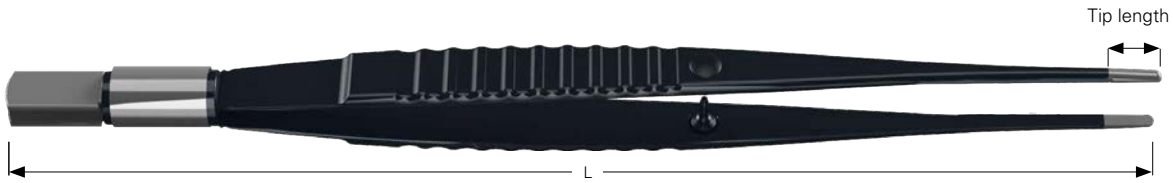

Order quantity: 1 piece





| Version | Tip | L = 165 mm | L = 180 mm | L = 195 mm | L = 225 mm |
|---|--------------|------------------|------------------|------------------|------------------|
|  Bipolar forceps, Needle | 6 mm 8 mm | CH-700-16 | CH-700-18 | CH-700-20 | CH-700-22 |
|  Bipolar forceps, Blunt, 1.0 mm | 6 mm 8 mm | CH-710-16 | CH-710-18 | CH-710-20 | CH-710-22 |
|  Bipolar forceps, Blunt, 2.0 mm | 6 mm 8 mm | CH-712-16 | CH-712-18 | CH-712-20 | CH-712-22 |

Bipolar Forceps, angled, flat-plug, 500 Vp



Order quantity: 1 piece



| Version | Tip | L = 165 mm | L = 180 mm | L = 190 mm | L = 225 mm |
|--|--------------|------------------|------------------|------------------|------------------|
|  Bipolar forceps, Needle | 6 mm 8 mm | CH-720-16 | CH-720-18 | CH-720-20 | CH-720-22 |
|  Bipolar forceps, Blunt, 1.0 mm | 6 mm 8 mm | CH-730-16 | CH-730-18 | CH-730-20 | CH-730-22 |
|  Bipolar forceps, Blunt, 2.0 mm | 6 mm 8 mm | | CH-732-18 | CH-732-20 | CH-732-22 |

! All bipolar forceps also with NON-STICK tip available

NON-STICK Silver tip

Bipolar Forceps





Bipolar Forceps, bayonet, flat-plug, 500 Vp



Order quantity: 1 piece



| Version | Tip | L = 165 mm | L = 180 mm | L = 195 mm | L = 220 mm | L = 240 mm |
|---|--------------|------------------|------------------|------------------|------------------|------------------|
|  Bipolar forceps, Needle | 6 mm 8 mm | CH-740-16 | CH-740-18 | CH-740-20 | CH-740-22 | |
|  Bipolar forceps, Blunt, 1.0 mm | 6 mm 8 mm | CH-750-16 | CH-750-18 | CH-750-20 | CH-750-22 | CH-750-24 |
|  B Bipolar forceps, Blunt, 2.0 mm | 6 mm 8 mm | CH-752-16 | CH-752-18 | CH-752-20 | CH-752-22 | CH-752-24 |





Plug instrument side

Bipolar connecting cables



Flat plug, square

Flat plug, round

| | Plug unit side | Length | Item number | |
|---|---------------------------------|--------|------------------|------------------|
|  | VALLEYLAB USA / 2 banana | 3,0 m | CH-217-30 | CH-247-30 |
| | | 5,0 m | CH-217-50 | CH-247-50 |
| 28,2 mm  | AMNOTOM BOWA VALLEYLAB EUROPE | 3,0 m | CH-215-30 | CH-245-30 |
| | | 5,0 m | CH-215-50 | CH-245-50 |
| Ø 7,8 mm  | MARTIN I BERCHTOLD | 3,0 m | CH-213-30 | CH-243-30 |
| | | 5,0 m | CH-213-50 | CH-243-50 |
| Ø 12,3 mm  | ERBE STORZ WISAP | 3,0 m | CH-211-30 | CH-241-30 |
| | | 5,0 m | CH-211-50 | CH-241-50 |

Bipolar Micro-Coagulation Forceps

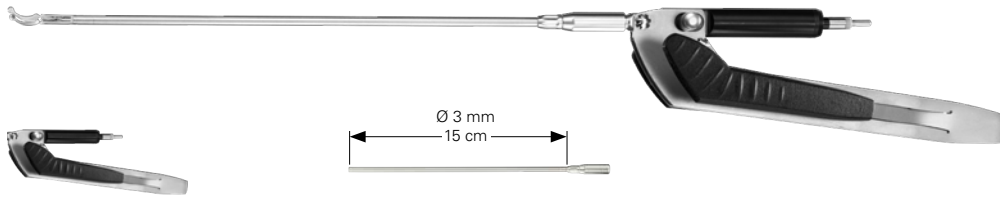

CH-100-00
Handle, bayonet

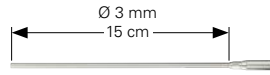

CH-100-02
Shaft, bayonet



CH-100-10
Ring handle

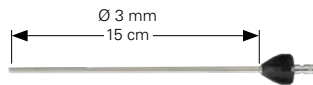

CH-100-12
Shaft, Ring handle

CH-100-90
Suction probe

Plug unit side

Length

Round plug



AMNOTOM | BOWA
VALLEYLAB EUROPE

3,0 m
5,0 m

CH-205-30
CH-205-50



MARTIN I
BERCHTOLD

3,0 m
5,0 m

CH-201-30
CH-201-50









ERBE | STORZ I
WISAP

3,0 m
5,0 m

CH-201-30
CH-201-50

Electrodes for Bipolar Micro-Coagulation Forceps

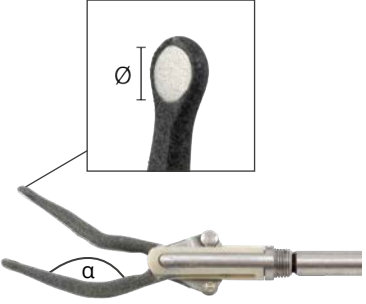
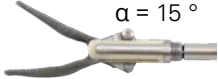
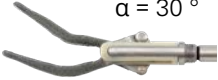
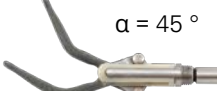

| | | | Insert, only | Complete, bayonet handle | Complete, ring handle |
|---|--------------------------------|------------------|--------------------|--------------------------|-----------------------|
|  | Scissors, curved | CH-120-03 | CH-120-03 C | CH-120-03 CS | |
|  | Grasping forceps, fenestrated | CH-102-03 | CH-102-03 C | CH-102-03 CS | |
|  | Spoon forceps Ø 2 mm, curved | CH-104-03 | CH-104-03 C | CH-104-03 CS | |
|  | Spoon forceps Ø 2.7 mm, curved | CH-106-03 | CH-106-03 C | CH-106-03 CS | |
|  | Dissector Maryland, curved | CH-108-03 | CH-108-03 C | CH-108-03 CS | |
|  | Dissector, angled | CH-110-03 | CH-110-03 C | CH-110-03 CS | |

| | | | Insert, only | Complete, bayonet handle | Complete, ring handle |
|---|-----------------------------------|----------------------------------|--|--|---|
|  | | | | | |
|  | Flamingo jaw, vertical α = 15° | Ø 0,7 mm Ø 1,2 mm Ø 2,0 mm | CH-112-07 CH-112-12 CH-112-20 | CH-112-07 C CH-112-12 C CH-112-20 C | CH-112-07 CS CH-112-12 CS CH-112-20 CS |
|  | Flamingo jaw, vertical α = 30° | Ø 0,7 mm Ø 1,2 mm Ø 2,0 mm | CH-114-07 CH-114-12 CH-114-20 | CH-114-07 C CH-114-12 C CH-114-20 C | CH-114-07 CS CH-114-12 CS CH-114-20 CS |
|  | Flamingo jaw, vertical α = 45° | Ø 0,7 mm Ø 1,2 mm Ø 2,0 mm | CH-116-07 CH-116-12 CH-116-20 | CH-116-07 C CH-116-12 C CH-116-20 C | CH-116-07 CS CH-116-12 CS CH-116-20 CS |

Bipolar Stitch Coagulation Electrodes

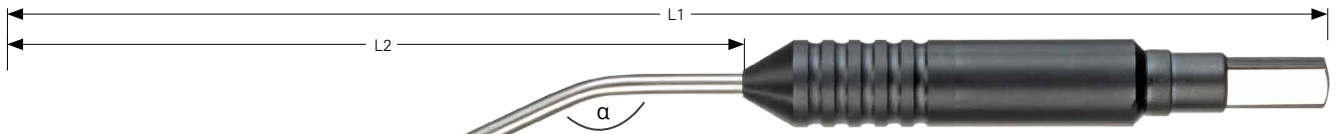

| Angle α | Length 1 | Length 2 | Item number |
|----------------|----------|----------|------------------|
| 20 ° | 190 mm | 105 mm | CH-670-00 |



| | | | |
|------|--------|--------|------------------|
| 30 ° | 195 mm | 110 mm | CH-670-02 |
|------|--------|--------|------------------|



| | | | |
|------|--------|--------|------------------|
| 55 ° | 195 mm | 112 mm | CH-670-04 |
|------|--------|--------|------------------|



| | | | |
|------|--------|-------|------------------|
| 60 ° | 175 mm | 90 mm | CH-670-06 |
|------|--------|-------|------------------|

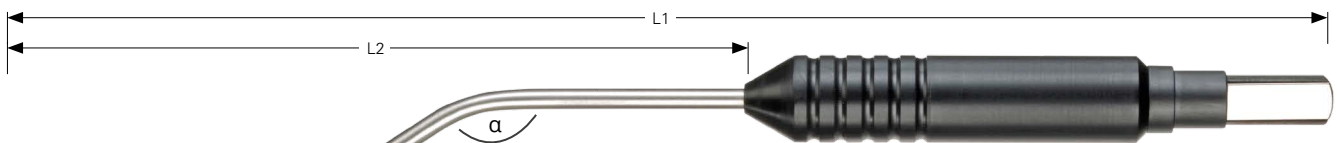

| Angle α | Length 1 | Length 2 | Item number |
|----------------|----------|----------|------------------|
| 30 ° | 190 mm | 105 mm | CH-670-10 |

Bipolar Probe Electrodes

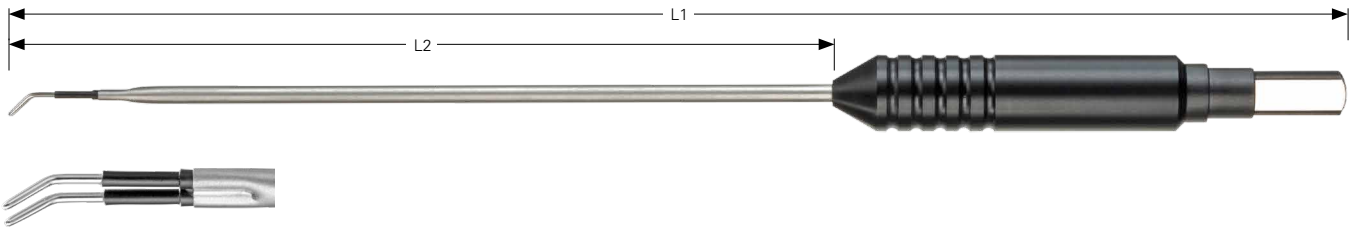

Tip 45° curved



| Angle α | Length 1 | Length 2 | Item number |
|----------------|----------|----------|------------------|
| 0 ° | 215 mm | 130 mm | CH-670-30 |

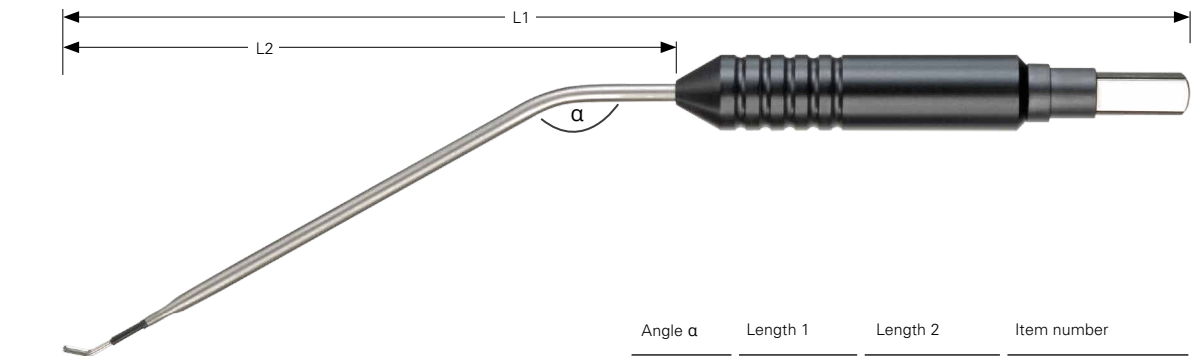

| Angle α | Length 1 | Length 2 | Item number |
|----------------|----------|----------|------------------|
| 30 ° | 185 mm | 100 mm | CH-670-32 |

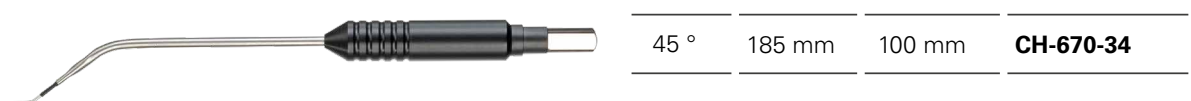

| Angle α | Length 1 | Length 2 | Item number |
|----------------|----------|----------|------------------|
| 45 ° | 185 mm | 100 mm | CH-670-34 |

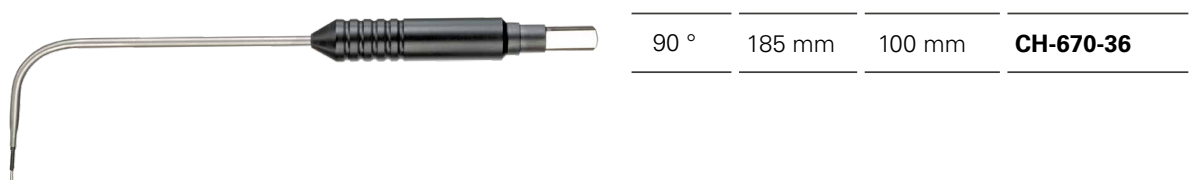









| Angle α | Length 1 | Length 2 | Item number |
|----------------|----------|----------|------------------|
| 90 ° | 185 mm | 100 mm | CH-670-36 |



Larynx Surgery



Table of Content I Chapter

| Product group | Page |
|---|----------------|
|  <p>Chest Support, Bipod, Operating Laryngoscopes and Accessories</p> | 287-290 |
|  <p>Laryngoscopes, Naso-Pharyngo-Laryngoscopes (flexible) LED old Light Cables and Adapters</p> | 291-294 |
|  <p>Laryngeal Mirrors, Rhinoscopic Mirror, Mirror Warmer / Optics Heater</p> | 295-296 |
|  <p>Laryngeal Syringes and Cannula, Epiglottis Retractor, Cotton Applicators</p> | 297-298 |
|  <p>Laryngeal Polypus Forceps, Scissors, Retractor</p> | 299-303 |
|  <p>Intubation Tube, Tracheotomy Trocar, Tracheal Dilato, Retractors</p> | 304-306 |
|  <p>Instruments for Endolaryngeal Micro Surgery</p> | 30-317 |
|  <p>Laryngeal Snare, Suction and Irrigation Instruments</p> | 318 |

Chest Support, Bipod



Chest support, for adults, complete with support rod

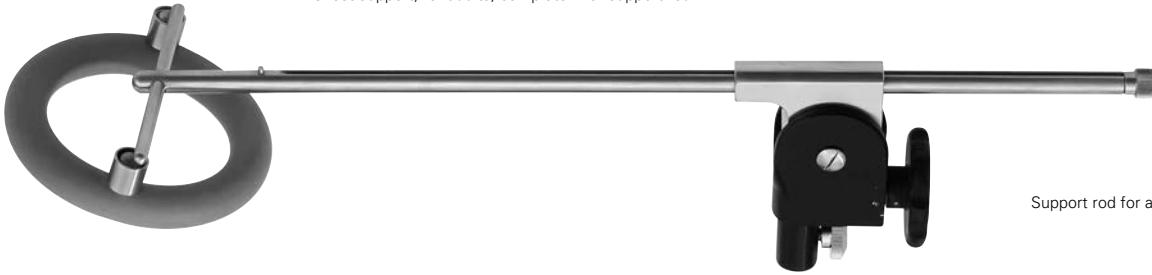

Support rod for adults

CH-280-00 34,0 cm, 13 $\frac{3}{8}$ "

CH-280-02 34,0 cm, 13 $\frac{3}{8}$ "

Chest support, for children, complete with support rod



Support rod for children

CH-280-10 24,0 cm, 9 $\frac{1}{2}$ "

CH-280-01 24,0 cm, 9 $\frac{1}{2}$ "

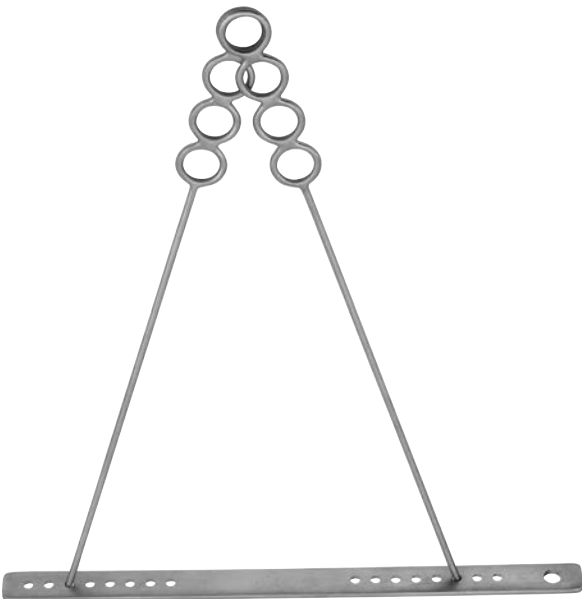

DRAFFIN

CH-060-92

CH-280-90

Silicone teeth protector, autoclavable

Operating Laryngoscopes



- CH-282-01** Fig. 1 | 135 mm
- CH-282-02** Fig. 2 | 152 mm
- CH-282-03** Fig. 3 | 182 mm
- CH-282-04** Fig. 4 | 172 mm
- CH-282-05** Fig. 5 | 172 mm
- CH-282-06** Fig. 6 | 182 mm
- CH-282-07** Fig. 7 | 222 mm



Fig. 1 | Ø 11 mm

CH-282-01

For infants



Fig. 2 | Ø 11 mm

CH-282-02

For children



Fig. 3 | Ø 12 mm

CH-282-03

For adults



Fig. 4 | Ø 14 mm

CH-282-04

For adults

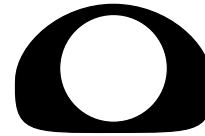

Fig. 5 | Ø 16 mm

CH-282-05

For adults

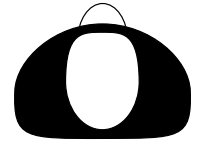

Fig. 6 | 13x18 mm

CH-282-06

For adults

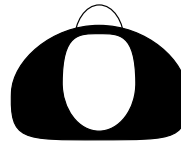

Fig. 7 | 13x18 mm

CH-282-07

For adults



- CH-282-11** Fig. 1 | 135 mm
- CH-282-12** Fig. 2 | 152 mm
- CH-282-13** Fig. 3 | 182 mm
- CH-282-14** Fig. 4 | 172 mm
- CH-282-15** Fig. 5 | 172 mm
- CH-282-16** Fig. 6 | 182 mm
- CH-282-17** Fig. 7 | 222 mm



Fig. 1 | Ø 11 mm

CH-282-11

For infants



Fig. 2 | Ø 11 mm

CH-282-12

For children



Fig. 3 | Ø 12 mm

CH-282-13

For adults



Fig. 4 | Ø 14 mm

CH-282-14

For adults



Fig. 5 | Ø 16 mm

CH-282-15

For adults

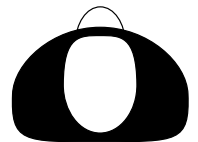

Fig. 6 | 13x18 mm

CH-282-16

For adults

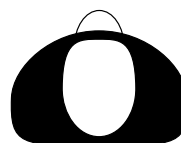
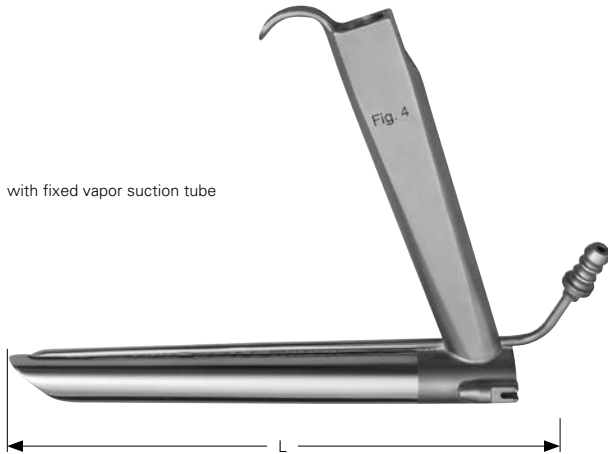

Fig. 7 | 13x18 mm

CH-282-17

For adults

Operating Laryngoscopes



- CH-282-21** Fig. 1 | 135 mm
- CH-282-22** Fig. 2 | 152 mm
- CH-282-23** Fig. 3 | 182 mm
- CH-282-24** Fig. 4 | 172 mm
- CH-282-25** Fig. 5 | 172 mm
- CH-282-26** Fig. 6 | 182 mm
- CH-282-27** Fig. 7 | 222 mm



Fig. 1 | Ø 11 mm
CH-282-21
For infants



Fig. 2 | Ø 11 mm
CH-282-22
For children



Fig. 3 | Ø 12 mm
CH-282-23
For adults

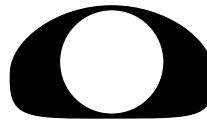

Fig. 4 | Ø 14 mm
CH-282-24
For adults

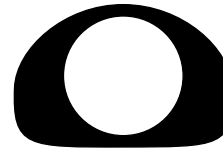

Fig. 5 | Ø 16 mm
CH-282-25
For adults

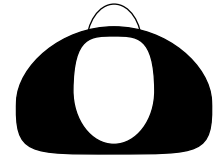

Fig. 6 | 13x18 mm
CH-282-26
For adults

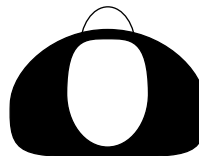
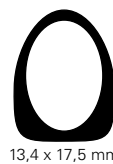
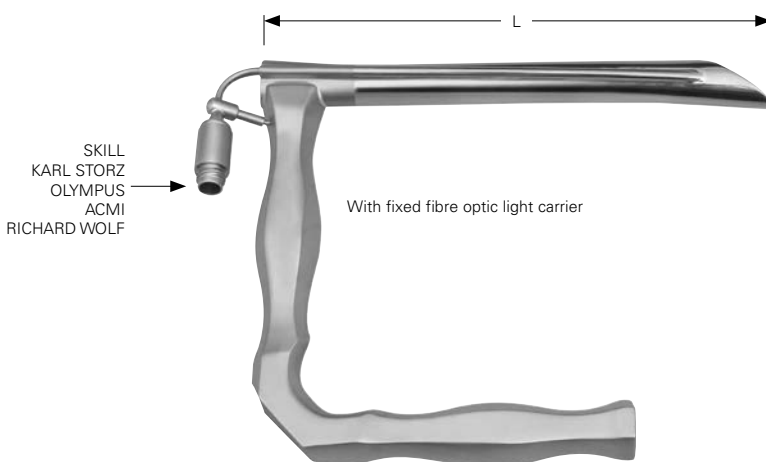

Fig. 7 | 13x18 mm
CH-282-27
For adults



13,4 x 17,5 mm

HOLINGER

- CH-286-01** Fig. 1 | 120 mm
- CH-286-02** Fig. 2 | 171 mm
- CH-286-03** Fig. 3 | 180 mm

Operating Laryngoscopes, Teeth Protector



Fibre optic light carrier for laryngoscope CH-282-01 - CH-282-27



- CH-283-01** Fig. 1 - 2
- CH-283-02** Fig. 3 - 6
- CH-283-03** Fig. 7

Injection Cannula for laryngoscopes CH-282-01 - CH-282-27

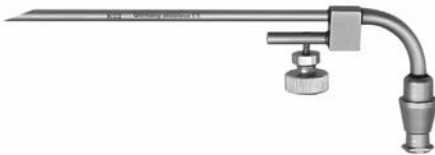

CH-284-00 Fig. 1 - 7

Vapor suction tube for laryngoscopes CH-282-01 - CH-282-27



CH-285-00 Fig. 3 - 7

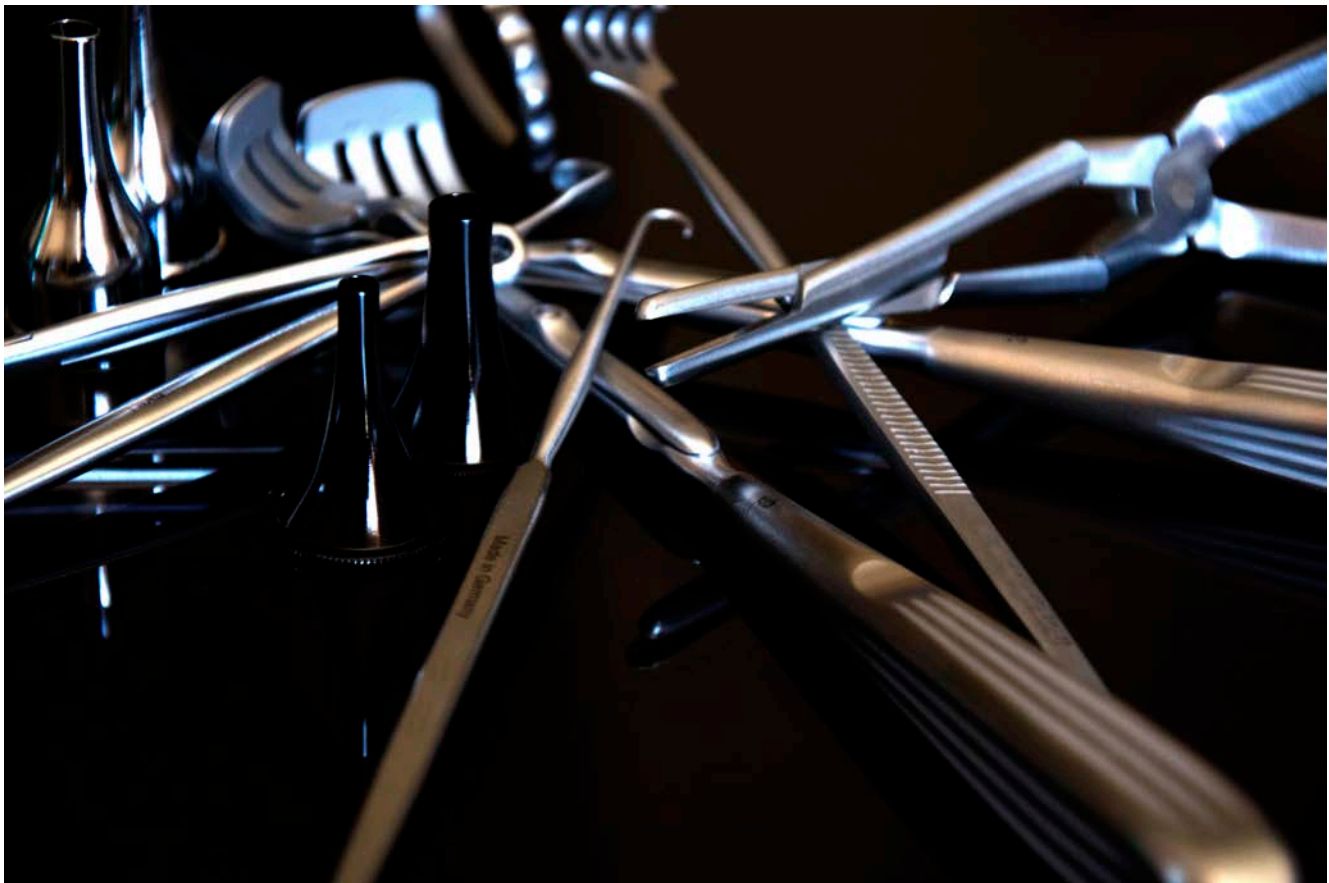

Laryngoscopes



HD LARYNGO

| Length | Ø | 70° | 90° |
|----------|---------|--|--|
| 190,0 mm | 10,0 mm | CH-108-70 ■ | CH-108-90 ■ |

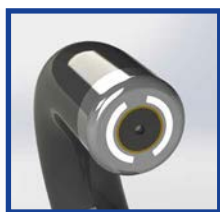

Flexible Naso-Pharyngo-/ Laryngofibrescopes

**Accessories:**

- Leakage tester
- ETO-Cap

CH-149-00 Ø 2,2 mm

One hand control, 2-side angulation, length of angulated tip 20 mm

| Length | Fibre bundle | Angulation up down | Direction of view | Field of view | Depth of field |
|--------|--------------|----------------------|-------------------|---------------|----------------|
| 300 mm | 6.500 Pixel | 160° 160° | 0° | 88° | 3 - 50 mm |

72-150-00 Ø 2,8 mm

One hand control, 2-side angulation, length of angulated tip 20 mm

| Length | Fibre bundle | Angulation up down | Direction of view | Field of view | Depth of field |
|--------|--------------|----------------------|-------------------|---------------|----------------|
| 300 mm | 16.000 Pixel | 160° 160° | 0° | 85° | 1 - 50 mm |

CH-152-00 Ø 3,2 mm

One hand control, 2-side angulation, length of angulated tip 20 mm

| Length | Fibre bundle | Angulation up down | Direction of view | Field of view | Depth of field |
|--------|--------------|----------------------|-------------------|---------------|----------------|
| 300 mm | 16.000 Pixel | 160° 160° | 0° | 85° | 1 - 50 mm |

CH-154-00 Ø 3,4 mm

One hand control, 2-side angulation, length of angulated tip 25 mm

| Length | Fibre bundle | Angulation up down | Direction of view | Field of view | Depth of field |
|--------|--------------|----------------------|-------------------|---------------|----------------|
| 300 mm | 16.000 Pixel | 160° 160° | 0° | 85° | 1 - 50 mm |

Flexible Naso-Pharyngo- / Laryngofibrescope with Instrument Channel



Accessories:
 - Leakage tester
 - ETO-Cap

CH-156-00 Ø 3,8 mm

One hand control, 2-side angulation, length of angulated tip 20 mm, **instrument channel Ø 1.4 mm**

| Length | Fibre bundle | Angulation up down | Direction of view | Field of view | Depth of field |
|--------|--------------|----------------------|-------------------|---------------|----------------|
| 300 mm | 14.000 Pixel | 160° 160° | 0° | 85° | 3 - 50 mm |



LED Cold Light Cables and Adapters



Cold light cables for LED cold light sources



Ø 2,5 mm for Endoscopes Ø 1.7 - 2.0 mm

Ø 3,5 mm for Endoscopes Ø 2.7 - 4.0 mm

LED

| | Cable, only | Cable with 2 adapters (SKILL STORZ) | Cable, only | Cable with 2 adapters (SKILL STORZ) |
|----------|------------------|---------------------------------------|------------------|---------------------------------------|
| Length | Ø 2,5 mm | Ø 2,5 mm | Ø 3,5 mm | Ø 3,5 mm |
| 180,0 cm | CH-133-18 | CH-133-18 C | CH-134-18 | CH-134-18 C |
| 230,0 cm | CH-133-23 | CH-133-23 C | CH-134-23 | CH-134-23 C |
| 250,0 cm | CH-133-25 | CH-133-25 C | CH-134-25 | CH-134-25 C |
| 300,0 cm | CH-133-30 | CH-133-30 C | CH-134-30 | CH-134-30 C |
| 350,0 cm | | | CH-134-35 | CH-134-35 C |
| 400,0 cm | CH-133-40 | CH-133-40 C | CH-134-40 | CH-134-40 C |
| 500,0 cm | CH-133-50 | CH-133-50 C | CH-134-50 | CH-134-50 C |

Adapter unit side



CH-128-00 CH-128-01 CH-128-03 CH-128-04

SKILL
STORZ
AESCULAP
LINVATEC
WISAP

WOLF
HSW
DYONICS
MEDICON
COMEG

OLYMPUS
NEW (switch)

ACMI
BRITISH
CODMAN
STRYKER
WELCH ALLYN

Adapter endoscope side



CH-129-00 CH-129-01 CH-129-04

SKILL
STORZ
AESCULAP
WINTER & IBE
WISAP

WOLF Snap
HSW
DYONICS
MEDICON

OLYMPUS
NEW

Further adapters for all current endoscopes and light sources available on request

Laryngeal Mirrors, Rhinoscopic Mirrors

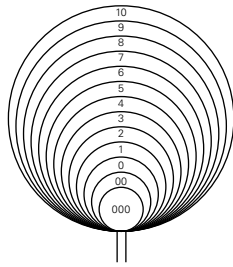

- CH-200-06** 6 mm | Fig. 000
- CH-200-08** 8 mm | Fig. 00
- CH-200-10** 10 mm | Fig. 0
- CH-200-12** 12 mm | Fig. 1
- CH-200-14** 14 mm | Fig. 2
- CH-200-16** 16 mm | Fig. 3
- CH-200-18** 18 mm | Fig. 4
- CH-200-20** 20 mm | Fig. 5
- CH-200-22** 22 mm | Fig. 6
- CH-200-24** 24 mm | Fig. 7
- CH-200-26** 26 mm | Fig. 8
- CH-200-28** 28 mm | Fig. 9
- CH-200-30** 30 mm | Fig. 10

Laryngeal mirrors, without handle



Metal handle



Metal handle

CH-200-06 - CH-200-30 14,0 cm, 5 ½ "

CH-201-00 10,0 cm, 4 "

CH-202-00 10,5 cm, 4 ¼ "

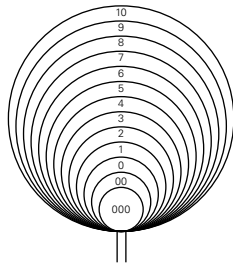

- CH-210-06** 6 mm | Fig. 000
- CH-210-08** 8 mm | Fig. 00
- CH-210-10** 10 mm | Fig. 0
- CH-210-12** 12 mm | Fig. 1
- CH-210-14** 14 mm | Fig. 2
- CH-210-16** 16 mm | Fig. 3
- CH-210-18** 18 mm | Fig. 4
- CH-210-20** 20 mm | Fig. 5
- CH-210-22** 22 mm | Fig. 6
- CH-210-24** 24 mm | Fig. 7
- CH-210-26** 26 mm | Fig. 8
- CH-210-28** 28 mm | Fig. 9
- CH-210-30** 30 mm | Fig. 10

Laryngeal mirrors, with fixed handle

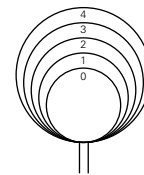

- CH-230-10** 10 mm | Fig. 0
- CH-230-12** 12 mm | Fig. 1
- CH-230-14** 14 mm | Fig. 2
- CH-230-16** 16 mm | Fig. 3
- CH-230-18** 18 mm | Fig. 4

Rhinoscopic mirrors, moveable

CH-210-06 - CH-210-30 19,0 cm, 7 ½ "

MICHEL

CH-230-10 - CH-230-18 25,0 cm, 9 ¾ "

Mirror Warmer/ Optics Heater**SKILL**
Ingenieur Instrumente**CH-225-90**

Infrared anti fog warmer for heating up mouth- and laryngeal mirrors or endoscopes.

Technical specification

| | |
|--------------------------------|---|
| Classification: | Class I (according annex IX 93/42/EWG) |
| Power supply: | Mains voltage 230 V |
| Power consumption: | 35 W |
| Temperature at focus point: | approx. 300 °C |
| Switching time: | 10 s |
| Dimension: | ø 86 x 140 mm |



Laryngeal Syringes and Cannula



LUER

| | |
|------------------|---------|
| CH-840-01 | 1,0 ml |
| CH-840-02 | 2,0 ml |
| CH-840-05 | 5,0 ml |
| CH-840-10 | 10,0 ml |
| CH-840-20 | 20,0 ml |
| CH-840-50 | 50,0 ml |



LUER-LOCK

| | |
|------------------|---------|
| CH-844-01 | 1,0 ml |
| CH-844-02 | 2,0 ml |
| CH-844-05 | 5,0 ml |
| CH-844-10 | 10,0 ml |
| CH-844-20 | 20,0 ml |
| CH-844-50 | 50,0 ml |



LUER-LOCK

| | |
|------------------|---------|
| CH-848-02 | 2,0 ml |
| CH-848-05 | 5,0 ml |
| CH-848-10 | 10,0 ml |
| CH-848-20 | 20,0 ml |

Barrels for CH-848-02 - CH-848-20



LUER-LOCK

| | |
|------------------|---------|
| CH-849-02 | 2,0 ml |
| CH-849-05 | 5,0 ml |
| CH-849-10 | 10,0 ml |
| CH-849-20 | 20,0 ml |

CH-871-99 Laryngeal Syringes with cannula



LUER-LOCK

| | |
|------------------|---------|
| CH-871-02 | 2,0 ml |
| CH-871-05 | 5,0 ml |
| CH-871-10 | 10,0 ml |

Laryngeal cannula



LUER-LOCK

| |
|------------------|
| CH-871-99 |
|------------------|

Epiglottis Retractor, Cotton Applicators



REICHERT

CH-241-23 24,0 cm, 9 ¼ "



KILLIAN

CH-243-25 25,0 cm, 9 ¾ "

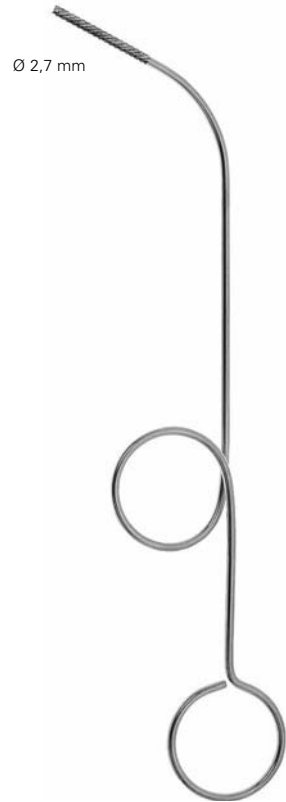

PELTESON

CH-245-23 23,0 cm, 9 "

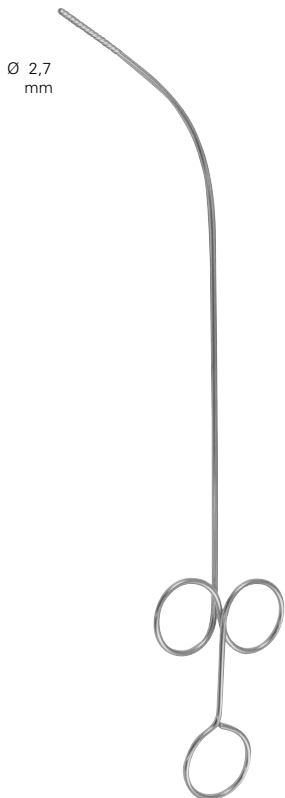

FEIN

CH-245-28 28,0 cm, 11 "

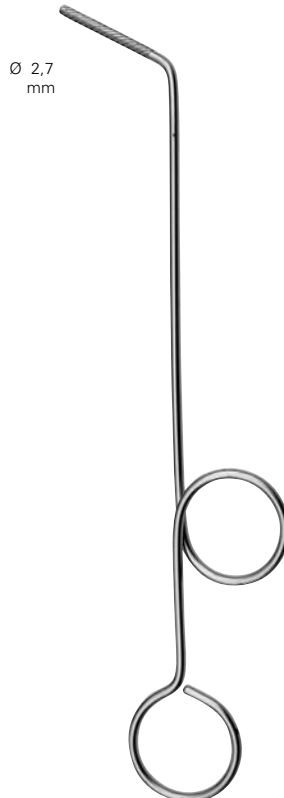

HARTMANN

CH-246-22 22,0 cm, 8 ¾ "

Laryngeal Polypus Forceps

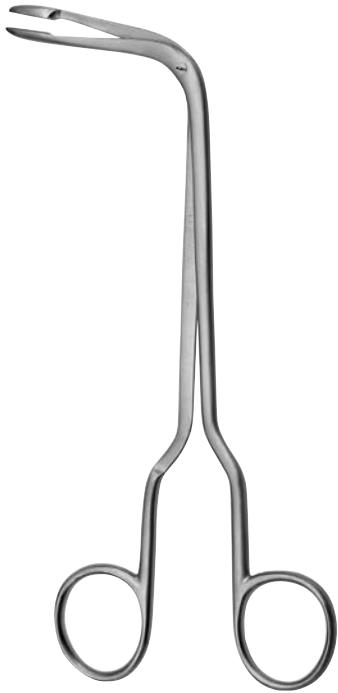

FRAENKEL

CH-247-22 18,0 cm, 7 "



TOBOLD

CH-249-23 23,0 cm, 9 "



CH-251-01

Right

CH-251-02

Left

CH-251-03

Downwards

CH-251-04

Upwards



JURASZ

CH-251-01 - CH-251-04 22,0 cm, 8 $\frac{3}{4}$ "

Laryngeal Polypus Forceps

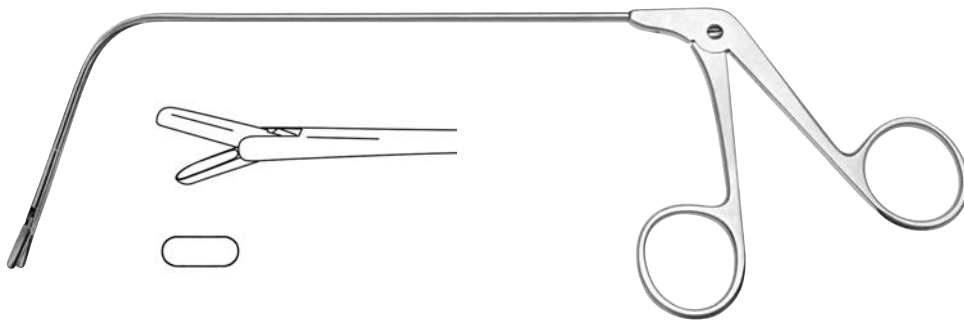

FRAENKEL

CH-252-28 17,0 cm, 6 3/4"

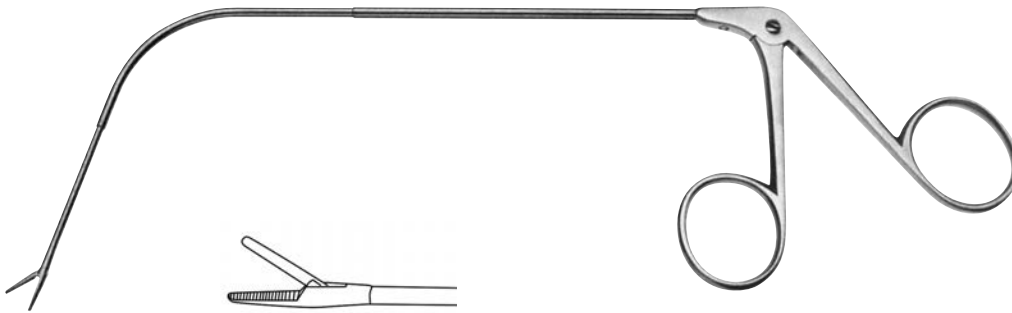

CH-254-28 17,0 cm, 6 3/4"



Laryngeal Forceps



Universal Handle

HUBER

CH-262-00



BRUENINGS

CH-262-20 200 mm

CH-262-30 300 mm

CH-262-40 400 mm

CH-262-50 500 mm

CH-262-60 600 mm

Elongation tubes



BRUENINGS

Elongation tube

CH-267-20 200 mm



BRUENINGS

Elongation tube, malleable

CH-268-20

Laryngeal Forceps



FRAENKEL
CH-270-01



SEIFFERT
CH-270-04



BRUENINGS
CH-270-06 Ø 3,0 mm
CH-270-07 Ø 4,0 mm



LANGE
CH-270-08 Ø 4,0 mm



BRUENINGS
CH-270-09 Ø 3,0 mm
CH-270-10 Ø 4,0 mm



FRAENKEL
CH-270-11



BRUENINGS
CH-270-12 2,5 x 5,0 mm
CH-270-13 3,0 x 6,0 mm



SCHEINMANN
CH-270-14



KRAUSE
CH-270-15



KRAUSE
CH-270-16



KRAUSE
CH-270-17



SCHEINMANN
CH-270-18



SCHUMACHER
CH-270-19



CORDES
CH-270-22 1,0 x 3,0 mm
CH-270-23 2,0 x 4,0 mm
CH-270-24 3,0 x 5,0 mm



CORDES
CH-270-25 1,0 x 3,0 mm
CH-270-26 2,0 x 4,0 mm
CH-270-27 3,0 x 5,0 mm
CH-270-28 4,0 x 8,0 mm

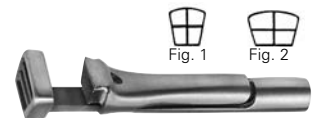

CORDES
CH-270-30 Fig. 1
CH-270-31 Fig. 2



FRAENKEL
CH-270-33

Laryngectomy Scissors, Retractor

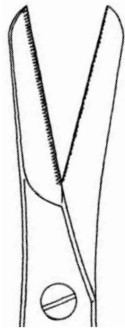

Serrated

CAPLAN

CH-841-20 20,0 cm, 8"

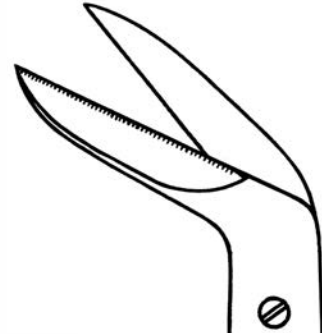

Serrated

KILLIAN

CH-843-21 20,0 cm, 8"

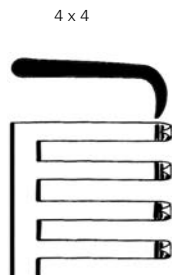

4 x 4

CH-229-17

Sharp

HENDERSON

CH-229-17 17,0 cm, 6 3/4"

Intubation Tube, Tracheotomy Trocar, Tracheal Dilator

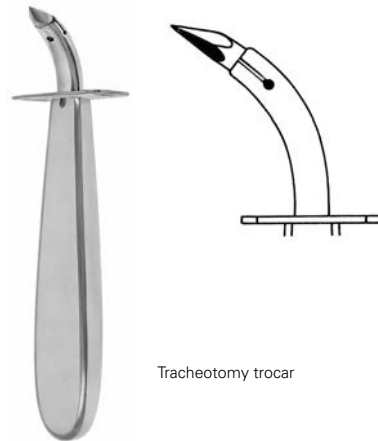
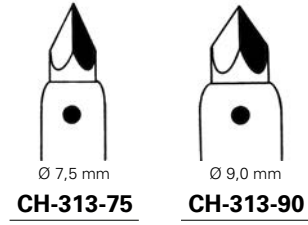
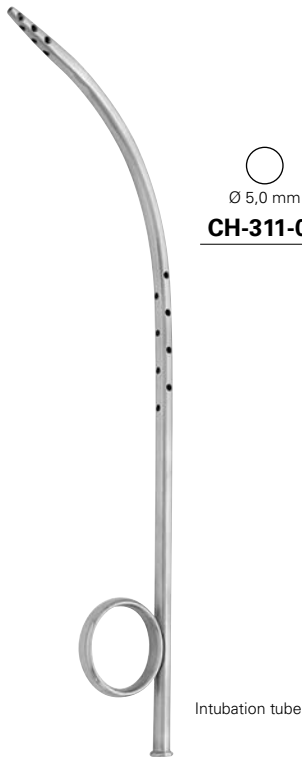

Tracheotomy trocar

MOSHER-BRUENINGS

CH-311-05 - CH-311-09 20,0 cm, 8"

UCKERMANN

CH-313-75 - CH-313-90 13,0 cm, 5 1/8"



Tracheal dilator

TROUSSEAU

CH-315-12 12,0 cm, 5"

CH-315-14 14,0 cm, 5 1/2"



Tracheal dilator

LABORDE

CH-317-12 12,5 cm, 5"



Tracheal dilator

LABORDE

CH-317-13 14,0 cm, 5 1/2"

Retractors

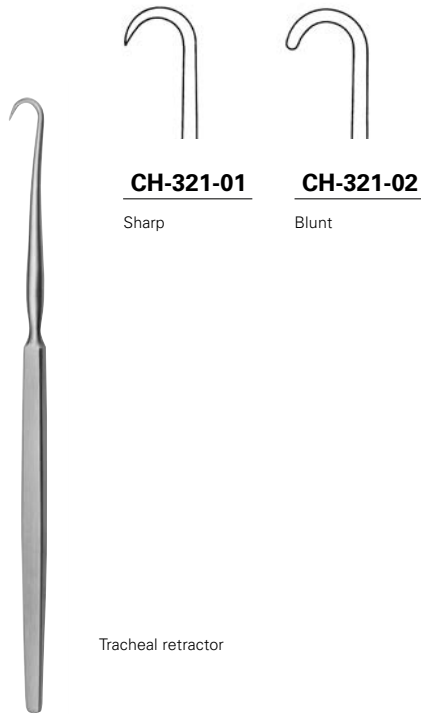

CH-321-01

Sharp

CH-321-02

Blunt

Tracheal retractor

ITERSON

CH-321-01 - CH-321-02 16,0 cm, 6 ¼"



CH-323-01

Sharp, left

Tracheal retractor

BOSE

CH-323-01 16,5 cm, 6 ½"

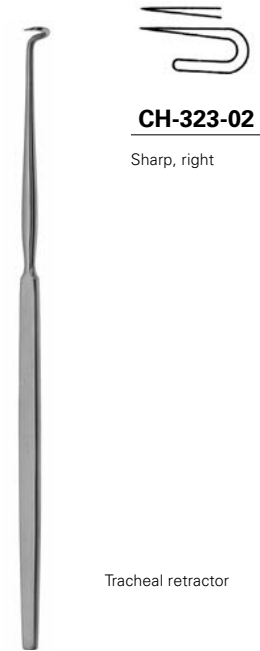

CH-323-02

Sharp, right

Tracheal retractor

BOSE

CH-323-02 16,5 cm, 6 ½"

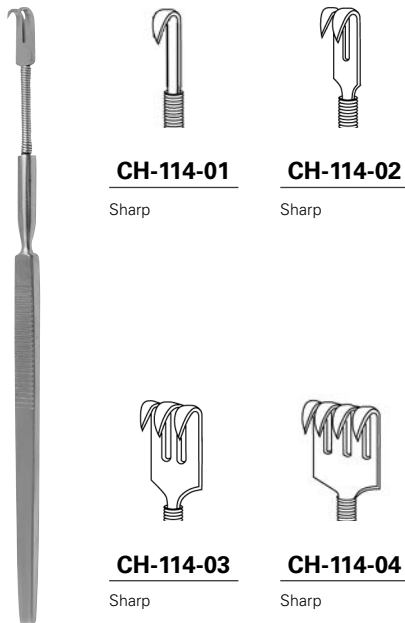

CH-114-01

Sharp

CH-114-02

Sharp

CH-114-03

Sharp

CH-114-04

Sharp

CH-114-01 - CH-114-04 16,0 cm, 6 ¼"

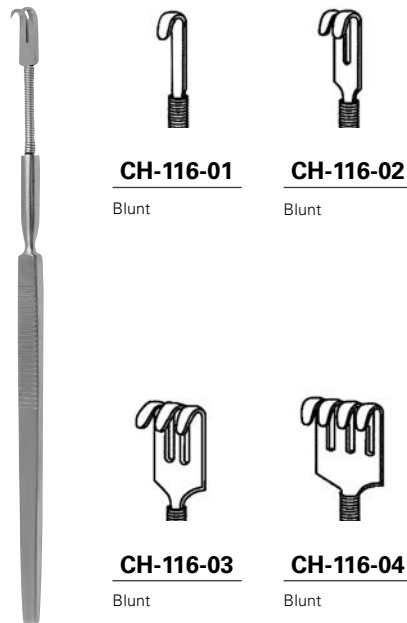

CH-116-01

Blunt

CH-116-02

Blunt

CH-116-03

Blunt

CH-116-04

Blunt

CH-116-01 - CH-116-04 16,0 cm, 6 ¼"

Retractors

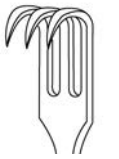

22,0 x 7,0 mm
CH-139-01

sharp

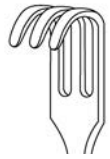

22,0 x 7,0 mm
CH-139-02

Blunt



18,0 x 6,0 mm
CH-139-03

sharp



SENN-MILLER

CH-139-01 - CH-139-03 16,0 cm, 6 ¼"



13,0 x 5,0 mm
CH-139-04

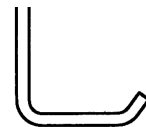

KILNER

CH-139-04 15,5 cm, 6"



6 x 13 mm

CH-337-21

Tracheal retractor

SCHOENBORN

CH-337-21 20,5 cm, 8"

Endolaryngeal Micro Surgery

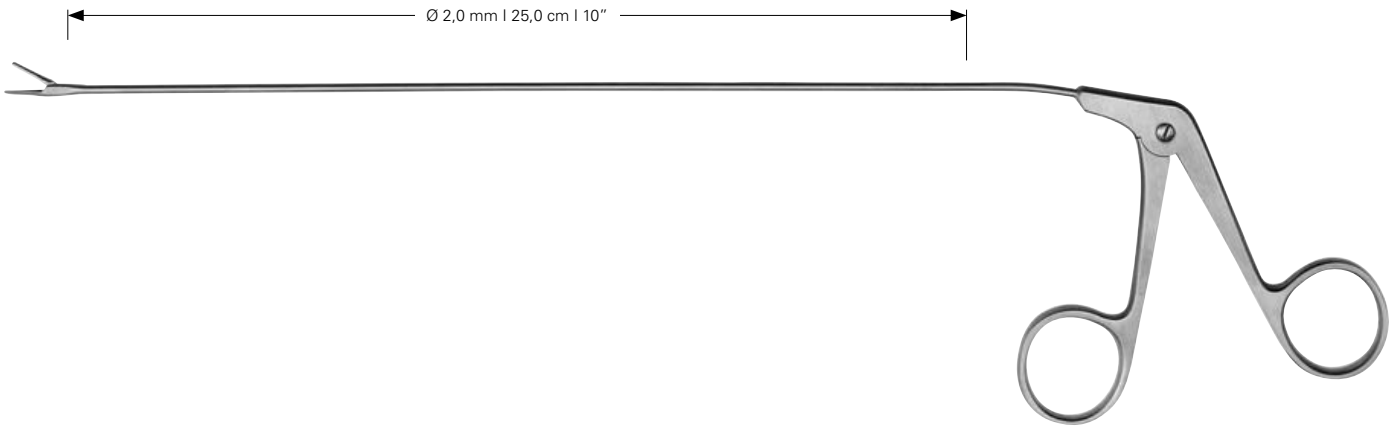

CH-290-01

Micro grasping forceps, straight



CH-290-04 Ø 2,0 mm

Micro cup-shaped forceps, straight

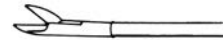

CH-290-08

Micro scissors, straight



CH-290-02

Micro grasping forceps, curved left



CH-290-05 Ø 2,0 mm

Micro cup-shaped forceps, curved left

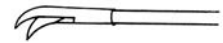

CH-290-09

Micro scissors, curved left



CH-290-03

Micro grasping forceps, curved right



CH-290-06 Ø 2,0 mm

Micro cup-shaped forceps, curved right

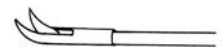

CH-290-10

Micro scissors, curved right



CH-290-07 Ø 2,0 mm

Micro cup-shaped forceps, curved upwards



CH-290-11

Micro scissors, curved upwards

Endolaryngeal Micro Surgery

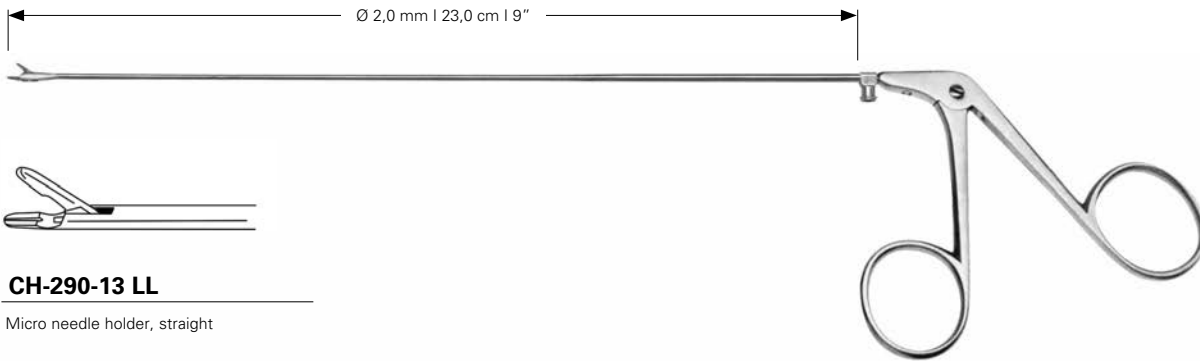

CH-290-13 LL

Micro needle holder, straight

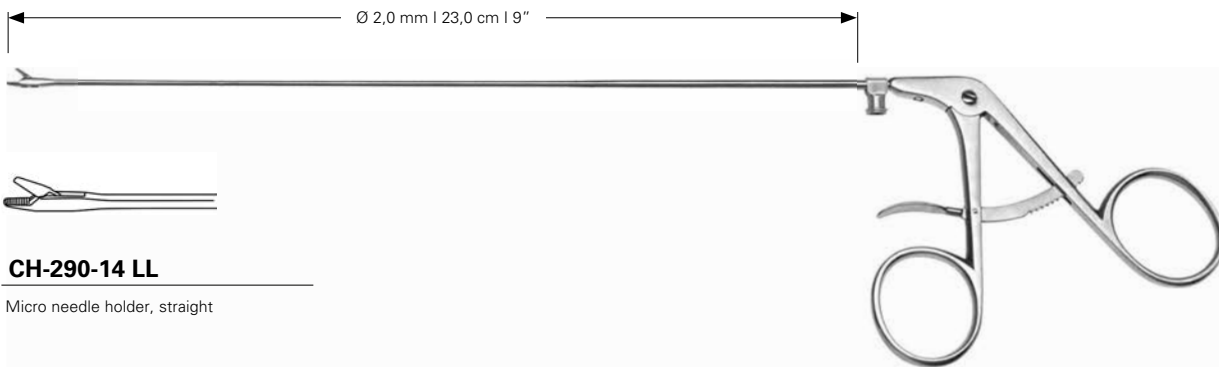

CH-290-14 LL

Micro needle holder, straight

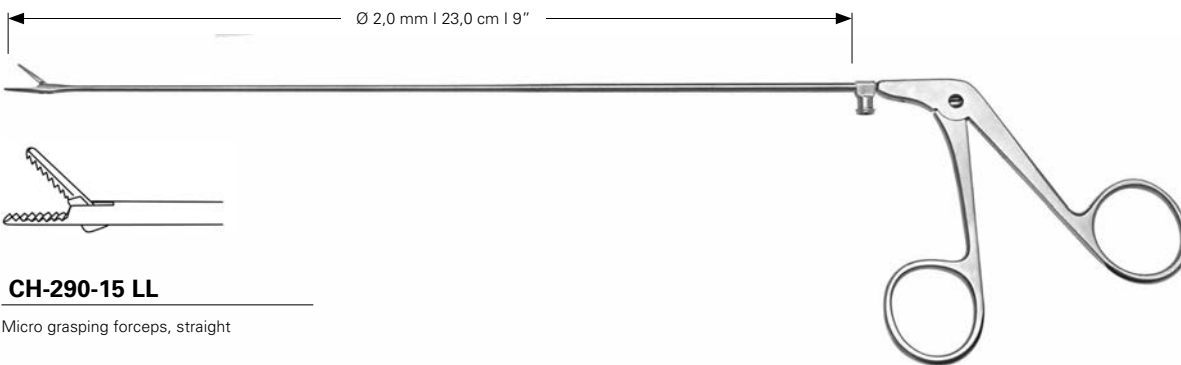

CH-290-15 LL

Micro grasping forceps, straight

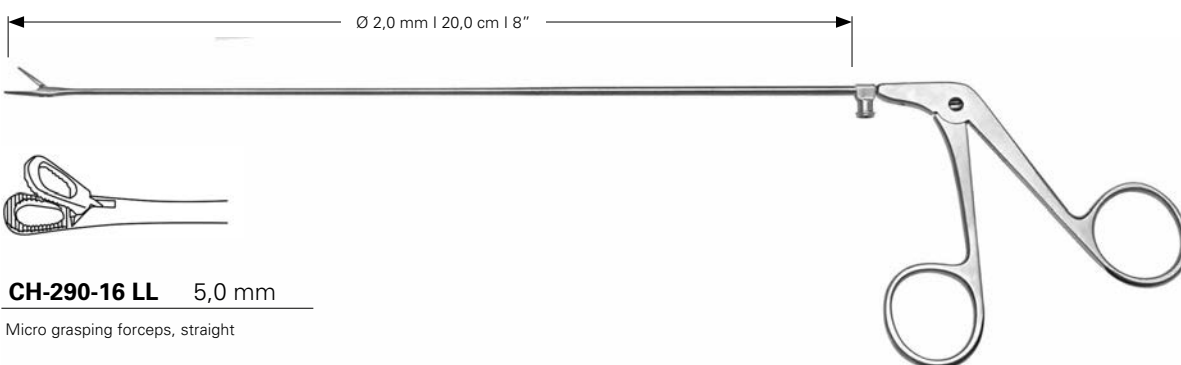

CH-290-16 LL 5,0 mm

Micro grasping forceps, straight

Endolaryngeal Micro Surgery

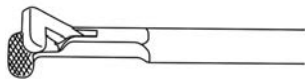
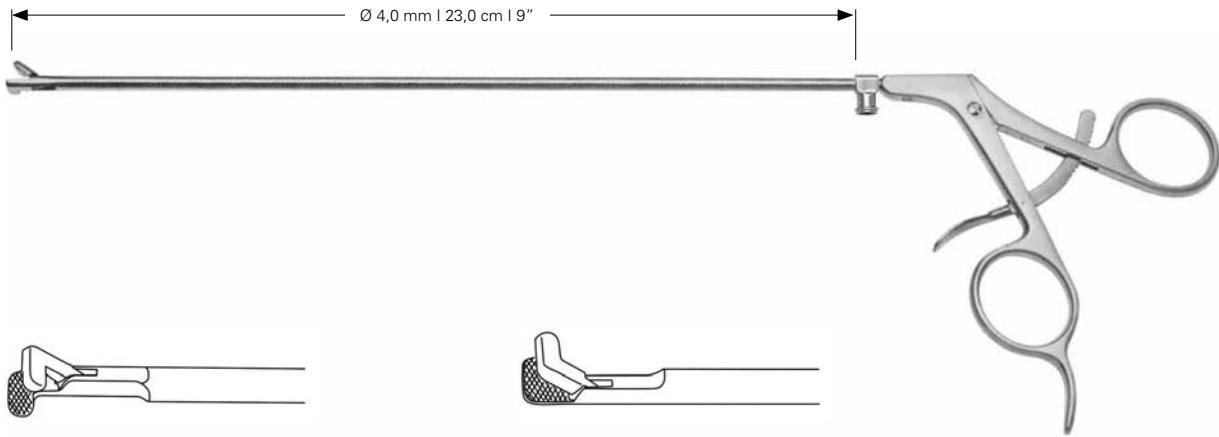

CH-290-17 LL 90°

Micro needle holder, curved left



CH-290-18 LL 90°

Micro needle holder, curved right

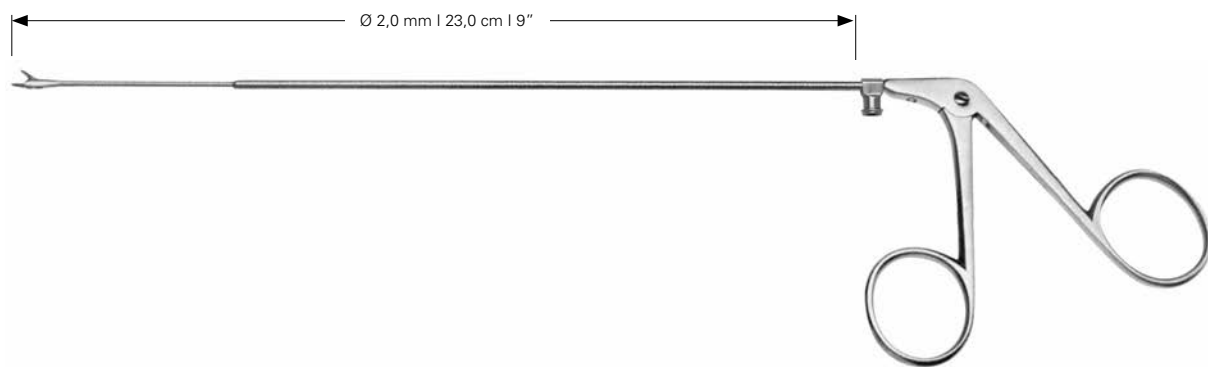

CH-290-20 LL

Micro scissors, straight



CH-290-21 LL 15°

CH-290-22 LL 45°

Micro scissors, curved upwards

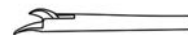

CH-290-23 LL

Micro scissors, curved left

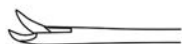

CH-290-24 LL

Micro scissors, curved right



CH-290-25 LL

Micro scissors, straight, horizontal opening

Endolaryngeal Micro Surgery

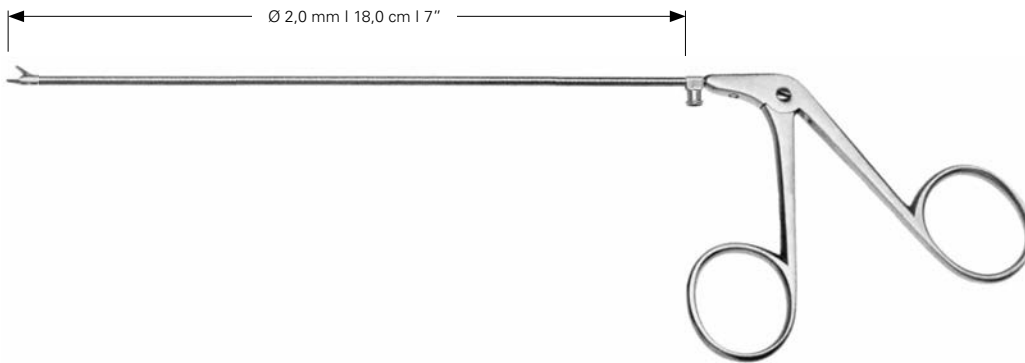

CH-290-26 LL

Micro scissors, straight



CH-290-27 LL 45°

Micro scissors, curved upwards



CH-290-34 LL

Micro scissors, curved left



CH-290-35 LL

Micro scissors, curved right

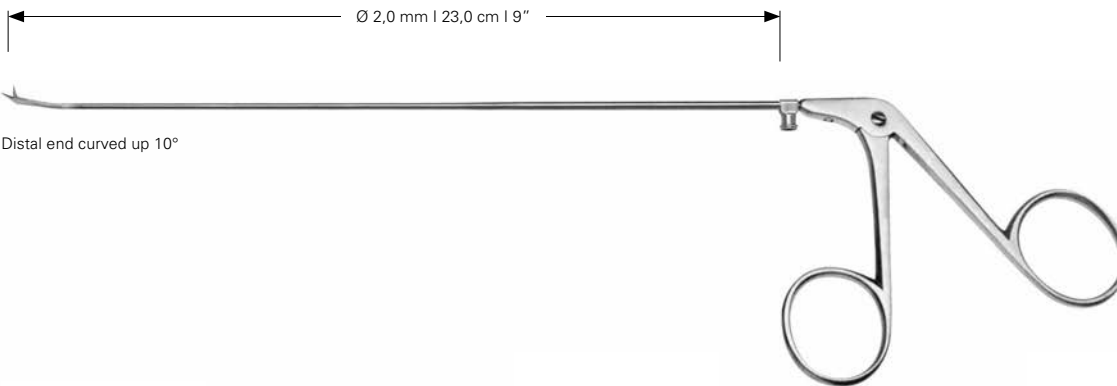

Distal end curved up 10°



CH-290-30 LL

Micro scissors, straight



CH-290-31 LL 45°

Micro scissors, curved upwards



CH-290-32 LL

Micro scissors, curved left



CH-290-33 LL

Micro scissors, curved right

Endolaryngeal Micro Surgery

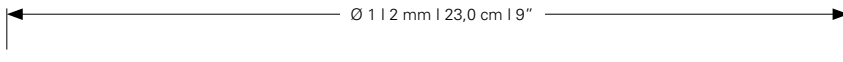

Delicate pattern



CH-290-40 LL

Micro scissors, straight



CH-290-41 LL 45°

Micro scissors, curved upwards



CH-290-42 LL

Micro scissors, curved left



CH-290-43 LL

Micro scissors, curved right

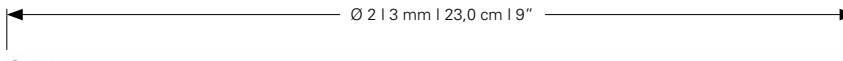

CH-291-00 LL

Micro grasping forceps, straight, with ratchet



CH-291-01 LL

Micro grasping forceps, straight



CH-291-02 LL

Micro grasping forceps, curved left



CH-291-03 LL

Micro grasping forceps, curved right



CH-291-11 LL

Micro grasping forceps, curved upwards



CH-291-12 LL

Micro grasping forceps, curved up left



CH-291-13 LL

Micro grasping forceps, curved up right

Endolaryngeal Micro Surgery

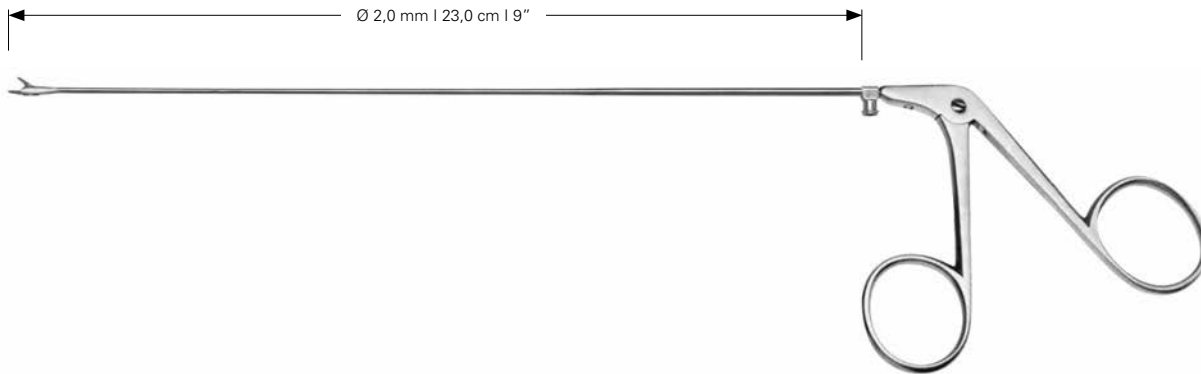

26-291-20 LL Ø 2,0 mm

Micro cup-shaped forceps, straight



26-291-21 LL Ø 2,0 mm

Micro cup-shaped forceps, curved upwards



26-291-22 LL Ø 2,0 mm

Micro cup-shaped forceps, curved left



26-291-23 LL Ø 2,0 mm

Micro cup-shaped forceps, curved right



26-291-32 LL Ø 2,0 mm

Micro cup-shaped forceps, curved up left



26-291-33 LL Ø 2,0 mm

Micro cup-shaped forceps, curved up right



26-291-42 LL Ø 2,0 mm

Micro cup-shaped forceps, horizontal, left



26-291-43 LL Ø 2,0 mm

Micro cup-shaped forceps, horizontal, right



Endolaryngeal Micro Surgery

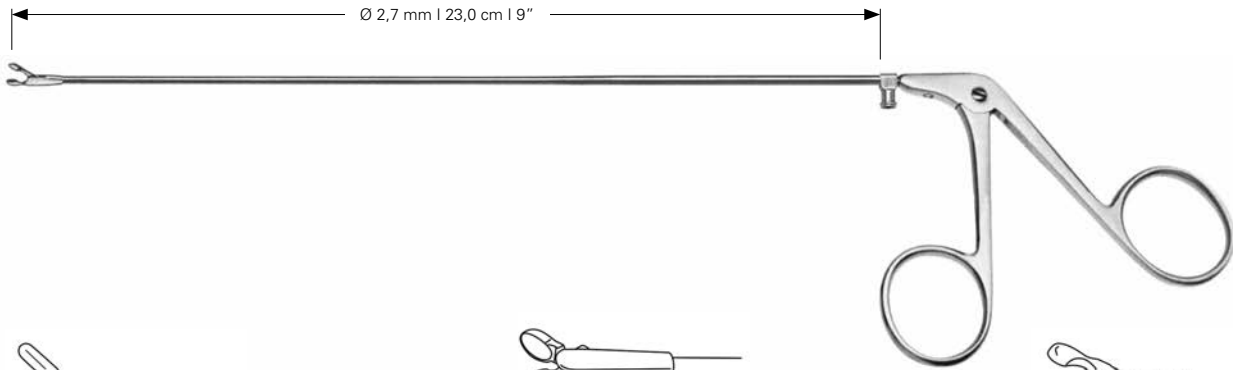

CH-291-44 LL 3,0 x 4,0 mm

Micro cup-shaped forceps, straight, heavy pattern

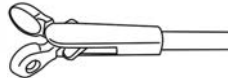

CH-291-45 LL Ø 4,0 mm

Micro cup-shaped forceps, straight



CH-291-50 LL Ø 4,0 mm

Mikro-Löffelzange, gerade



CH-291-51 LL Ø 4,0 mm

Micro cup-shaped forceps, curved upwards



CH-291-52 LL Ø 4,0 mm

Micro cup-shaped forceps, curved up left



CH-291-53 LL Ø 4,0 mm

Micro cup-shaped forceps, curved right

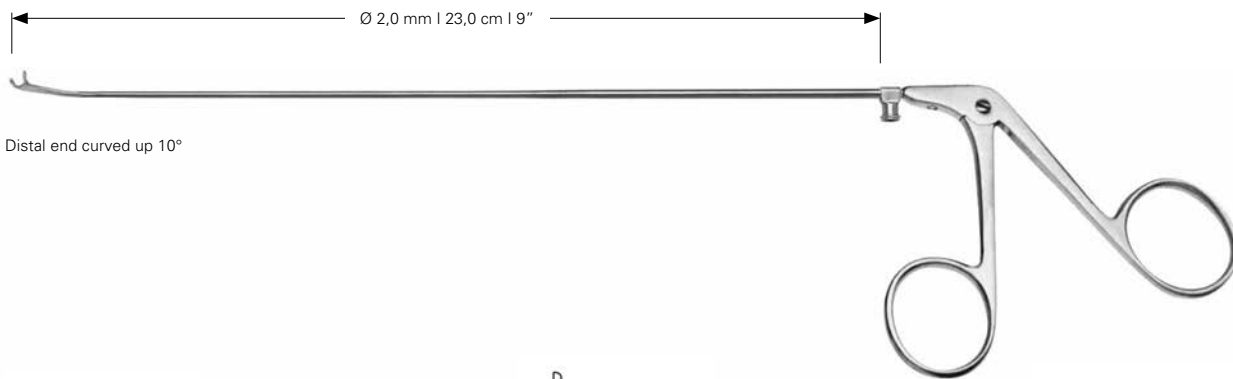

Distal end curved up 10°



CH-291-60 LL Ø 2,0 mm

Micro cup-shaped forceps, straight



CH-291-61 LL Ø 2,0 mm

Micro cup-shaped forceps, curved upwards



CH-291-62 LL Ø 2,0 mm

Micro cup-shaped forceps, curved left



CH-291-63 LL Ø 2,0 mm

Micro cup-shaped forceps, curved right

Endolaryngeal Micro Surgery

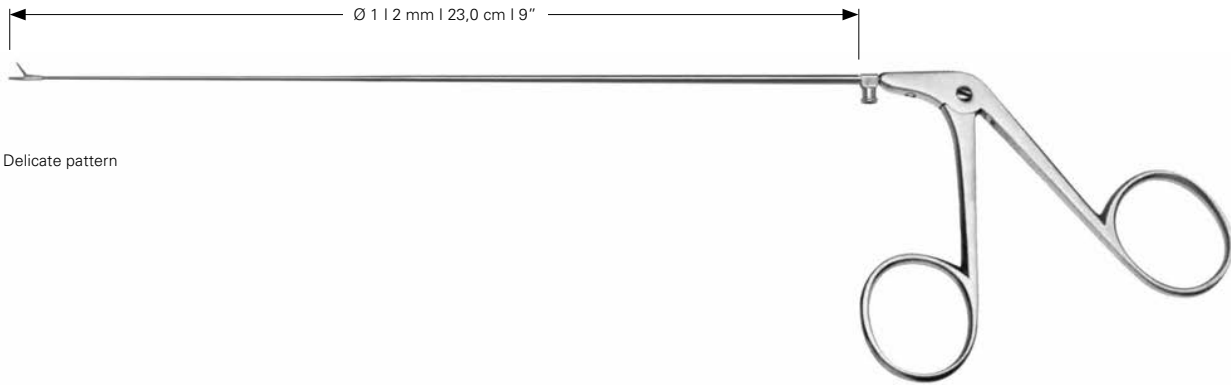

Delicate pattern



CH-292-01 LL

Micro grasping forceps, straight



CH-292-02 LL

Micro grasping forceps, curved left



CH-292-03 LL

Micro grasping forceps, curved right



CH-292-11 LL

Micro grasping forceps, curved upwards

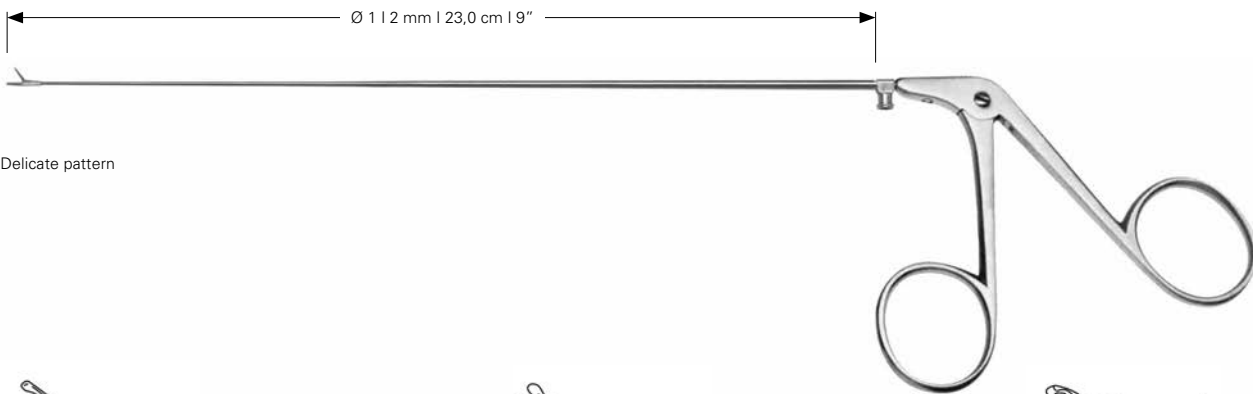

Delicate pattern



CH-292-20 LL Ø 1,0 mm

Micro cup-shaped forceps, straight



CH-292-21 LL Ø 1,0 mm

Micro cup-shaped forceps, curved upwards



CH-292-22 LL Ø 1,0 mm

Micro cup-shaped forceps, curved left



CH-292-23 LL Ø 1,0 mm

Micro cup-shaped forceps, curved right



CH-292-32 LL Ø 1,0 mm

Mikro-Löffelzange, links aufgebogen



CH-292-33 LL Ø 1,0 mm

Micro cup-shaped forceps, curved up right

Endolaryngeal Micro Surgery

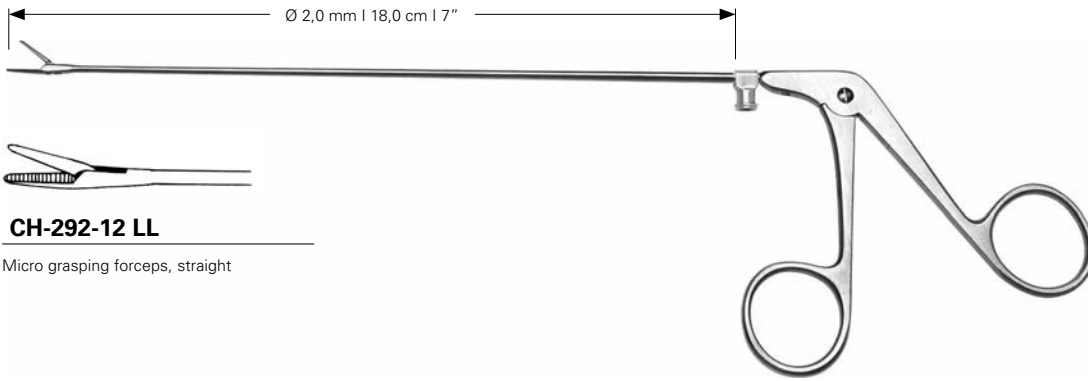

CH-292-12 LL

Micro grasping forceps, straight

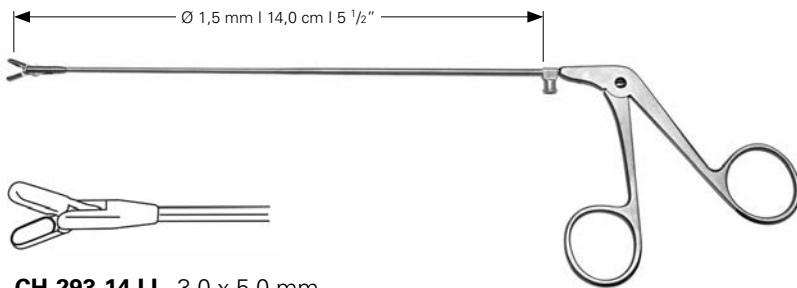

CH-293-14 LL 3,0 x 5,0 mm

Micro cup-shaped forceps, straight

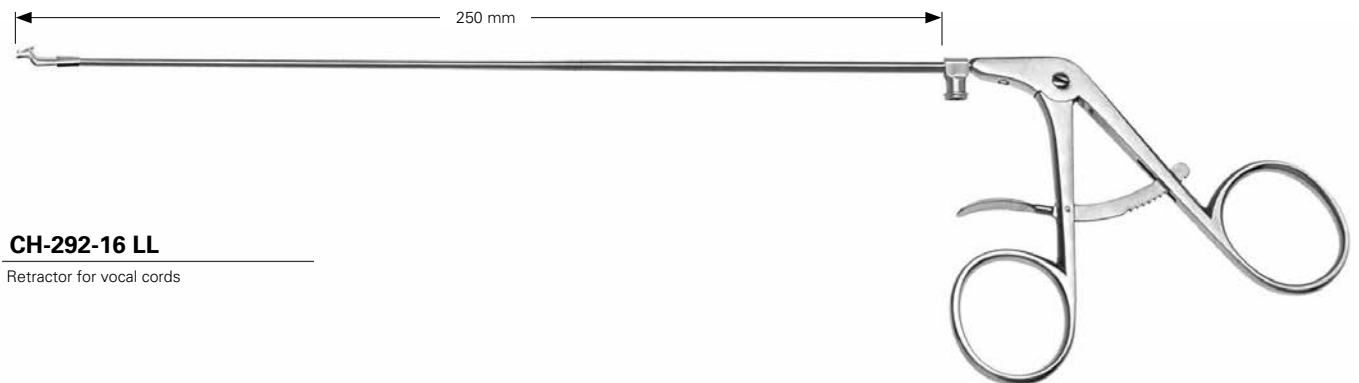

CH-292-16 LL

Retractor for vocal cords

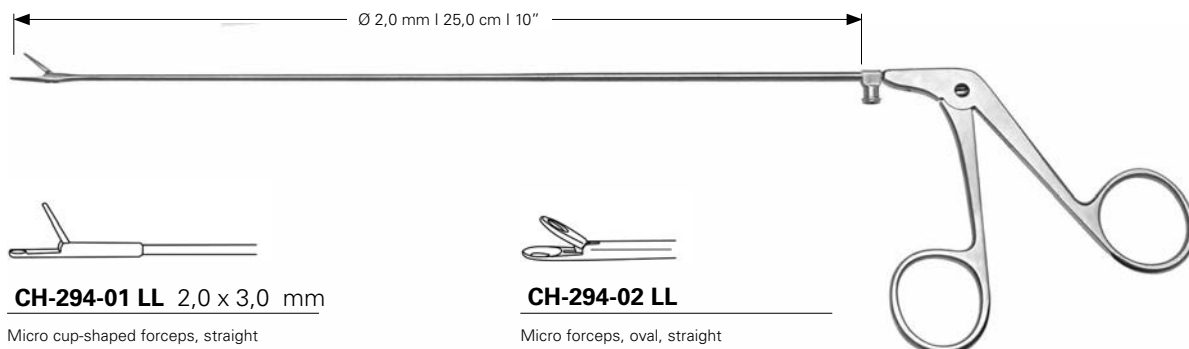

CH-294-01 LL 2,0 x 3,0 mm

Micro cup-shaped forceps, straight

CH-294-02 LL

Micro forceps, oval, straight

Endolaryngeal Micro Surgery

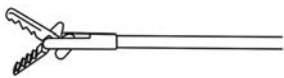
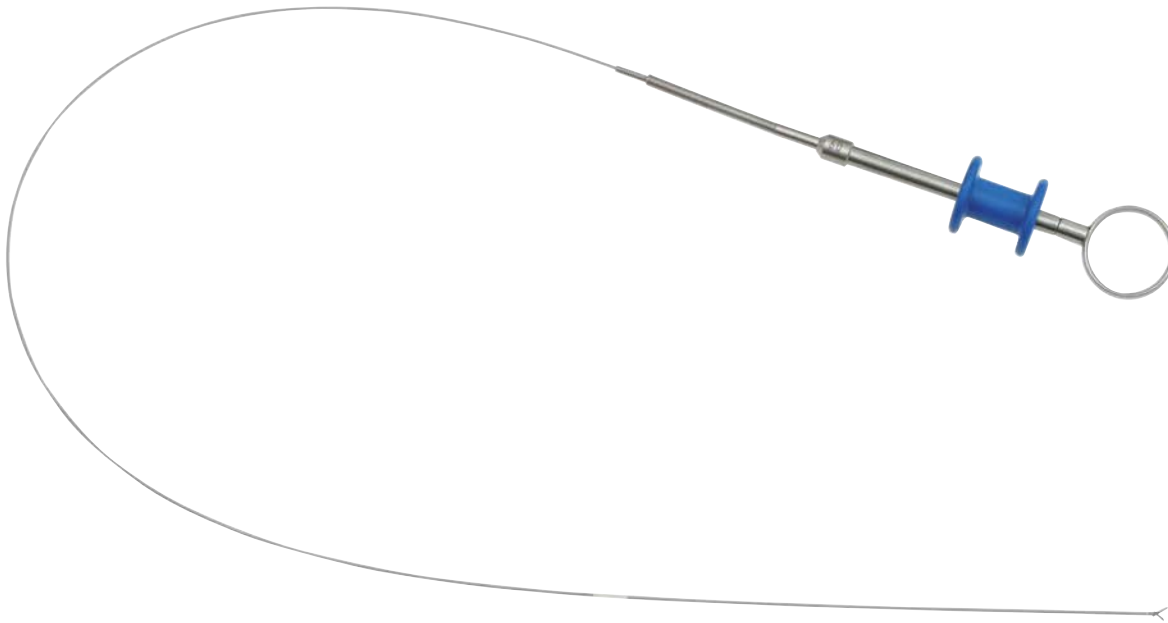

CH-295-01 Ø 1,0 x 120 cm

Micro grasping forceps, straight



CH-295-02 Ø 1,0 x 120 cm

Micro cup-shaped forceps, straight

Other patterns on request

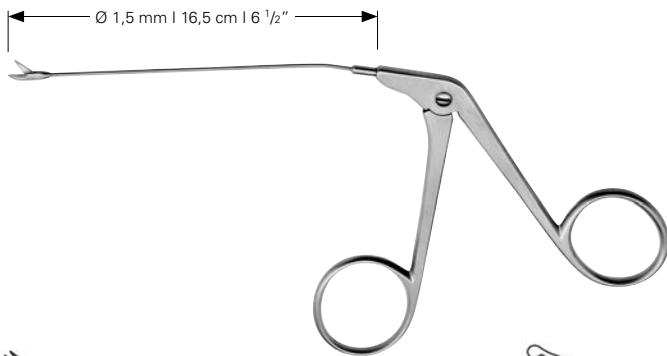

FAHLBUSCH

CH-296-00

Micro scissors, horizontal opening



NICOLA

CH-296-01 Ø 2,5 mm

Micro cup-shaped forceps, straight



YASARGIL-NICOLA

CH-296-02

Micro grasping forceps, straight

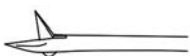

NICOLA

CH-296-03

Micro scissors, straight

Endolaryngeal Micro Surgery



CH-298-00 10,0 cm, 4 "

Handle for Laryngeal instruments



CH-298-01 24,0 cm, 9 1/2 "

Sickle knife



CH-298-02 24,0 cm, 9 1/2 "

Round edge knife



CH-298-03 24,0 cm, 9 1/2 "

Round edge knife



CH-298-04 24,0 cm, 9 1/2 "

Round edge knife, 45°



CH-298-05 24,0 cm, 9 1/2 "

Laryngeal hook, 90°



CH-298-06 24,0 cm, 9 1/2 "

Laryngeal hook, 30°



CH-298-07 24,0 cm, 9 1/2 "

Laryngeal hook



CH-298-08 24,0 cm, 9 1/2 "

Ligature guide



CH-298-09 24,0 cm, 9 1/2 "

Knot pusher

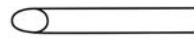

CH-298-10 24,0 cm, 9 1/2 "

Suction raspatory



CH-298-11 24,0 cm, 9 1/2 "

Tonsil ligature needle, right



CH-298-12 24,0 cm, 9 1/2 "

Tonsil ligature needle, left

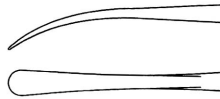

CH-298-13 24,0 cm, 9 1/2 "

Elevator, Blunt



CH-298-21 24,0 cm, 9 1/2 "

Laryngeal knife

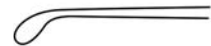

CH-298-22 24,0 cm, 9 1/2 "

Laryngeal knife



CH-298-23 28,0 cm, 11 "

Cotton applicator

Laryngeal Snare, Suction and Irrigation Instruments



Laryngeal snare

CH-297-05



Packing unit: 12 pieces

Snare wires



CH-297-99 Ø 0,3 mm

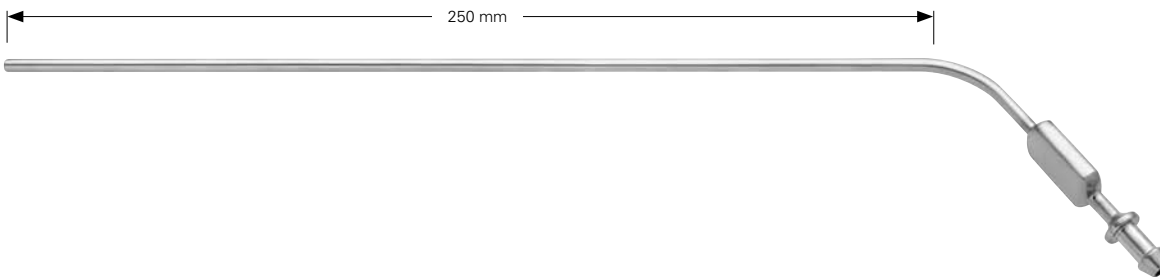

- CH-951-20** Ø 2,0 mm
- CH-951-25** Ø 2,5 mm
- CH-951-30** Ø 3,0 mm



General ENT Instruments



Table of Content | Chapter



















| Product group | Page | |
|---|---|----------------|
|  | Laryngoscopes and Accessories | 322-329 |
|  | Trocars | 330-332 |
|  | Suction and Irrigation Instruments | 333-345 |
|  | Scalpel Handles and Blades, Disposable Scalpels, Sterile | 346-352 |
|  | Surgical Scissors | 353-367 |
|  | Forceps | 368-380 |
|  | Haemostatic Forceps | 381-391 |
|  | Dissecting and Ligature Forceps | 392-393 |
|  | Tissue Grasping Forceps | 394-397 |

Table of Content | Chapter



| Product group | Page |
|---|---|
|  | Towel and Tubing Clamps, Safety Pins 398-403 |
|  | Sponge and Dressing Forceps 404-406 |
|  | Retractors, Wound Spreaders, SelfRetaining 407-424 |
|  | Needle Holders, Suture Instruments 425-441 |
|  | Lip and Cheek Retractors, Tounge Holding Forceps 442-443 |
|  | Septum Elevators, Mallets 444-448 |
|  | Bone Currettes, Raspatories, Elevators 450-458 |
|  | Rongeurs, Bone Cutting Forceps 459-467 |
|  | Stainless Steel Holloware 468-470 |

Standard Laryngoscopes and Accessories

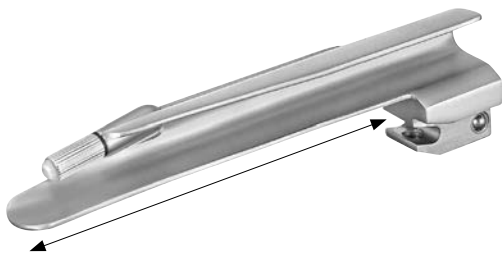

NEGUS (GUEDEL)

- CH-050-01** Fig 1 | 73 mm
- CH-050-02** Fig 2 | 102 mm
- CH-050-03** Fig 3 | 110 mm
- CH-050-04** Fig 4 | 135 mm

| | |
|----------|----------------|
| Fig. 0 | Fig. 3 |
| Newborns | Adult (small) |
| Fig. 1 | Fig. 4 |
| Infants | Adult (medium) |
| Fig. 2 | Fig. 5 |
| Children | Adult (large) |



CH-063-11 2,5 V

Spare Bulb , Fig. 1



CH-063-12 2,5 V

Spare Bulb , Fig. 2 - 4



NEGUS (GUEDEL)

CH-070-00 Fig. 1 - 2

Set, complete in case, consisting of:

- 1 Handle (CH-061-00)
- 1 Blade Fig. 1 - 2 (CH-050-01 | CH-050-02)

NEGUS (GUEDEL)

CH-071-00 Fig. 1 - 4

Set, complete in case, consisting of:

- 1 Handle (CH-061-00)
- 1 Blade Fig. 1 - 4 (CH-050-01 - CH-050-04)

Standard Laryngoscopes and Accessories



J

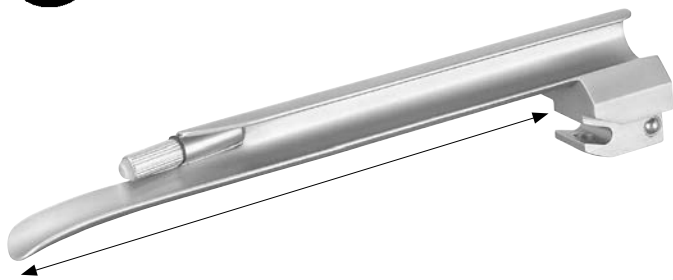

| | |
|----------|----------------|
| Fig. 0 | Fig. 3 |
| Newborns | Adult (small) |
| Fig. 1 | Fig. 4 |
| Infants | Adult (medium) |
| Fig. 2 | Fig. 5 |
| Children | Adult (large) |

MILLER

- CH-051-00** Fig 0 | 55 mm
- CH-051-01** Fig 1 | 80 mm
- CH-051-02** Fig 2 | 130 mm
- CH-051-03** Fig 3 | 170 mm
- CH-051-04** Fig 4 | 180 mm



CH-063-11 2,5 V

Spare Bulb , Fig. 0 - 1



CH-063-12 2,5 V

Spare Bulb , Fig. 2 - 4



MILLER

CH-073-00 Fig. 2 - 4

Set, complete in case, consisting of:

- 1 Handle (CH-061-00)
- 1 Blade Fig. 2 - 4 (CH-051-02 - CH-051-04)

MILLER

CH-074-00 Fig. 1 - 4

Set, complete in case, consisting of:

- 1 Handle (CH-061-00)
- 1 Blade Fig. 1 - 4 (CH-051-01 - CH-051-04)

Standard Laryngoscopes and Accessories



| | |
|----------|----------------|
| Fig. 0 | Fig. 3 |
| Newborns | Adult (small) |
| Fig. 1 | Fig. 4 |
| Infants | Adult (medium) |
| Fig. 2 | Fig. 5 |
| Children | Adult (large) |



MC INTOSH

- CH-052-00** Fig 0 | 56 mm
- CH-052-01** Fig 1 | 68 mm
- CH-052-02** Fig 2 | 88 mm
- CH-052-03** Fig 3 | 108 mm
- CH-052-04** Fig 4 | 128 mm
- CH-052-05** Fig 5 | 150 mm



CH-063-11 2,5 V

Spare Bulb , Fig. 0



CH-063-12 2,5 V

Spare Bulb , Fig. 1 - 5

MC INTOSH LED

CH-076-10 Fig. 1 - 3

Set, complete in case, consisting of:

- 1 Handle
- 1 Blade Fig. 1 - 3

MC INTOSH

CH-076-00 Fig. 1 - 3

Set, complete in case, consisting of:

- 1 Handle, (CH-061-00)
- 1 SBlade, Fig. 1 - 3 (CH-052-01 - CH-050-03)

MC INTOSH

CH-076-01 Fig. 2 - 4

Set, complete in case, consisting of:

- 1 Handle (CH-061-00)
- 1 Blade Fig. 2 - 4 (CH-050-02 - CH-050-04)

MC INTOSH

CH-077-00 Fig. 1 - 4

Set, complete in case, consisting of:

- 1 Handle CH-061-00)
- 1 Blade Fig. 1 - 4 (CH-052-01 - CH-052-04)



Standard Laryngoscopes and Accessories

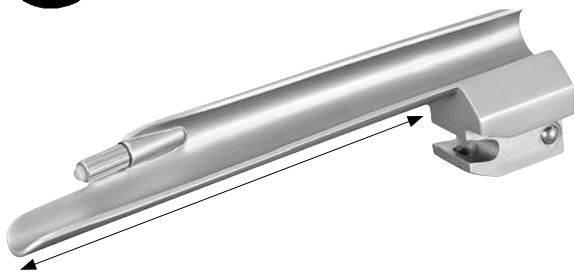

WIS-FOREGGER

- CH-053-00** Fig 0 | 73 mm
- CH-053-01** Fig 1 | 93 mm
- CH-053-02** Fig 2 | 111 mm
- CH-053-03** Fig 3 | 140 mm
- CH-053-04** Fig 4 | 165 mm

| | |
|----------|----------------|
| Fig. 0 | Fig. 3 |
| Newborns | Adult (small) |
| Fig. 1 | Fig. 4 |
| Infants | Adult (medium) |
| Fig. 2 | Fig. 5 |
| Children | Adult (large) |



CH-063-11 2,5 V

Spare Bulb , Fig. 0 - 1



CH-063-12 2,5 V

Spare Bulb , Fig. 2 - 4



WIS-FOREGGER

CH-078-00 Fig. 2 - 4

Set, complete in case, consisting of:

- 1 Handle (CH-061-00)
- 1 Blade Fig. 2 - 4 (CH-053-02 - CH-053-04)

WIS-FOREGGER

CH-079-00 Fig. 1 - 4

Set, complete in case, consisting of:

- 1 Handle CH-061-00)
- 1 Blade Fig. 1 - 4 (CH-053-01 - CH-053-04)

Laryngoscopes with Cold Light and Accessories



| | |
|----------|----------------|
| Fig. 0 | Fig. 3 |
| Newborns | Adult (small) |
| Fig. 1 | Fig. 4 |
| Infants | Adult (medium) |
| Fig. 2 | Fig. 5 |
| Children | Adult (large) |

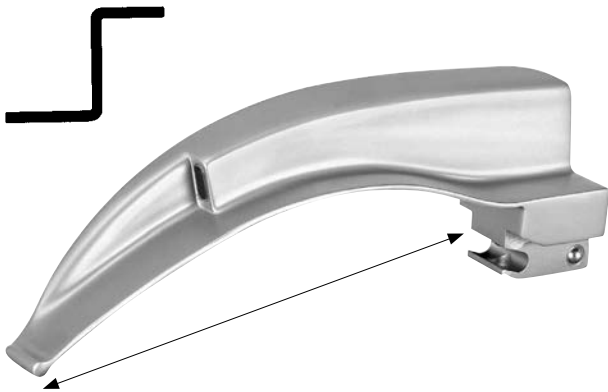

MC INTOSH ●

- CH-054-00** Fig 0 | 56 mm
- CH-054-01** Fig 1 | 68 mm
- CH-054-02** Fig 2 | 88 mm
- CH-054-03** Fig 3 | 108 mm
- CH-054-04** Fig 4 | 128 mm

Laryngoscope blade with integrated cold light carrier



MC INTOSH ●

CH-081-00 Fig. 1 - 3

Set, complete in case, consisting of:

- 1 Handle (CH-065-00)
- 1 Blade Fig. 1 - 3 (CH-054-01 - CH-CH-054-03)

MC INTOSH ●

CH-082-00 Fig. 1 - 4

Set, complete in case, consisting of:

- 1 Handle (CH-065-00)
- 1 Blade Fig. 1 - 4 (CH-054-01 - CH-054-04)

Laryngoscopes with Cold Light and Accessories



| | |
|----------|----------------|
| Fig. 0 | Fig. 3 |
| Newborns | Adult (small) |
| Fig. 1 | Fig. 4 |
| Infants | Adult (medium) |
| Fig. 2 | Fig. 5 |
| Children | Adult (large) |

J



MILLER



- CH-055-00** Fig 0 | 55 mm
- CH-055-01** Fig 1 | 80 mm
- CH-055-02** Fig 2 | 130 mm
- CH-055-03** Fig 3 | 170 mm
- CH-055-04** Fig 4 | 180 mm

Laryngoscope blade with integrated cold light carrier



MILLER



CH-083-00 Fig. 2 - 4

Set, complete in case, consisting of:

- 1 Handle (CH-065-00)
- 1 Blade Fig. 2 - 4 (CH-055-02 - Adult (medium))

MILLER



CH-084-00 Fig. 1 - 4

Set, complete in case, consisting of:

- 1 Handle CH-065-00)
- 1 Blade Fig. 1 - 4 (CH-055-01 - CH-055-04)

Standard Laryngoscopes and Accessories



Battery handle (2 AA batteries, 1.5 volt, are required)

CH-060-00 Ø 18,0 mm



Battery handle (2 A batteries, 1.5 volt, are required)

CH-061-00 Ø 30,0 mm

Battery handle (1 A batteries, 1.5 volt, are required)



CH-062-00 Ø 30,0 mm



Battery handle (for transformer)

CH-063-00 Ø 30,0 mm



Transformer

CH-063-01 220 V



Battery charging device

CH-063-03

Laryngoscopes with Cold Light and Accessories



Battery handle (2 AA batteries, 1.5 volt, are required)

CH-064-00 Ø 18,0 mm



Battery handle (2 A batteries, 1.5 volt, are required)

CH-065-00 Ø 30,0 mm



Battery handle (for transformer)

CH-065-01 Ø 30,0 mm



CH-069-03 2,5 V

LED Bulb



CH-069-02 2,5 V

Xenon Bulb



CH-069-01 2,5 V

Halogen Bulb



CH-069-00 2,5 V

Krypton Bulb



LED

CH-069-30 Ø 30,0 mm

Handle with accumulator (10-069-39)



LED

CH-069-40 115 V

10-069-50 230 V

Charging device

Trocars

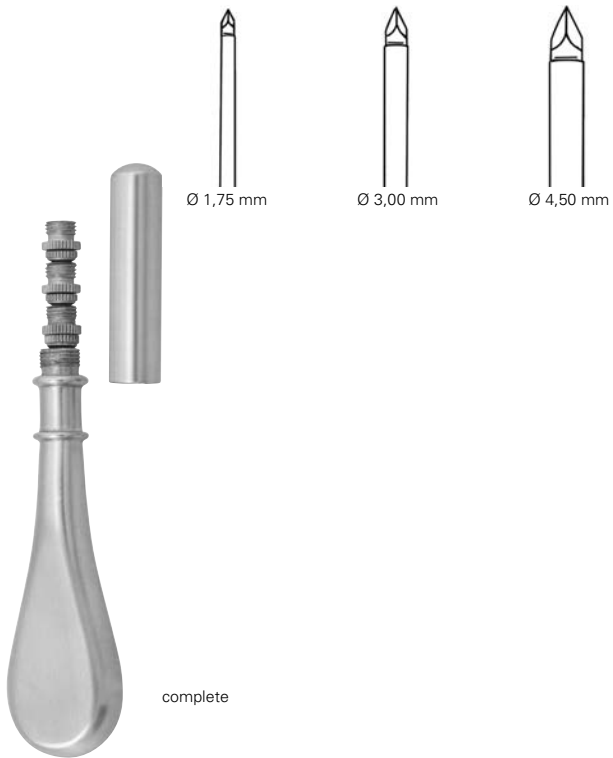

complete

UNIVERSAL

CH-720-03 14,0 cm, 5 1/2 "

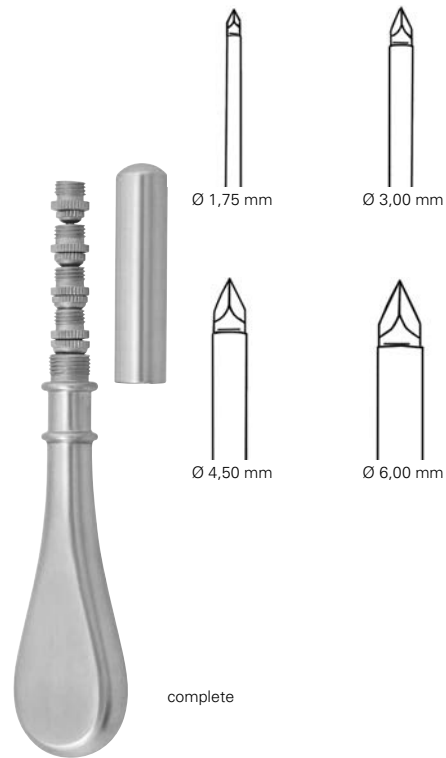

complete

UNIVERSAL

CH-720-04 14,0 cm, 5 1/2 "

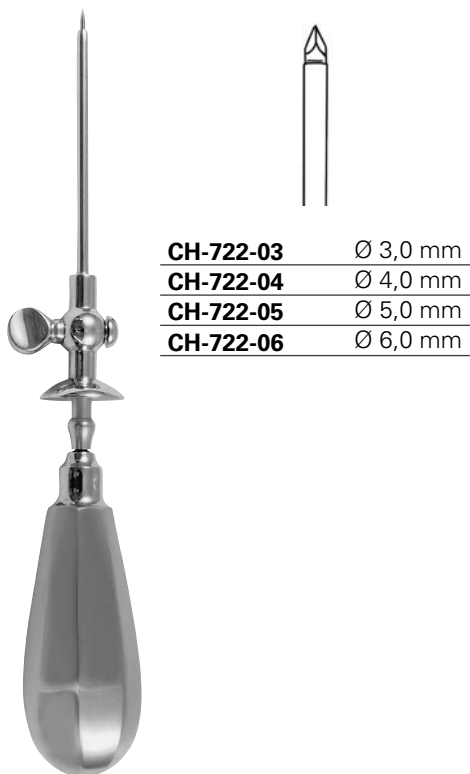

| | |
|------------------|----------|
| CH-722-03 | Ø 3,0 mm |
| CH-722-04 | Ø 4,0 mm |
| CH-722-05 | Ø 5,0 mm |
| CH-722-06 | Ø 6,0 mm |

STANDARD

CH-722-03 - CH-722-06 12,0 cm, 4 3/4 "

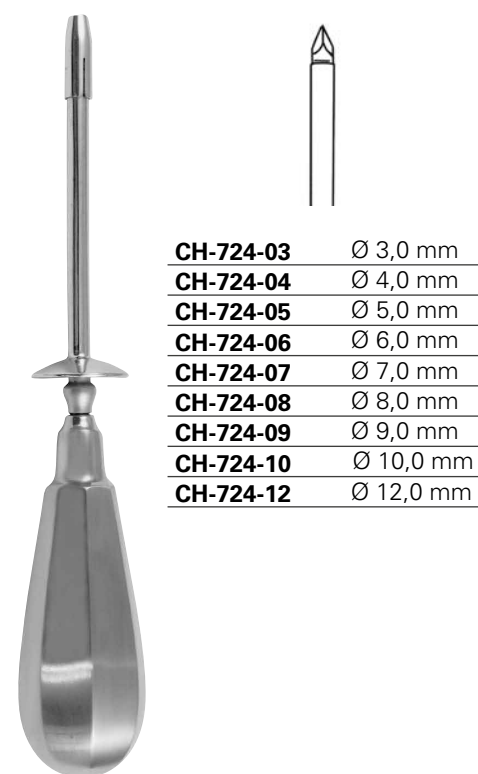

| | |
|------------------|-----------|
| CH-724-03 | Ø 3,0 mm |
| CH-724-04 | Ø 4,0 mm |
| CH-724-05 | Ø 5,0 mm |
| CH-724-06 | Ø 6,0 mm |
| CH-724-07 | Ø 7,0 mm |
| CH-724-08 | Ø 8,0 mm |
| CH-724-09 | Ø 9,0 mm |
| CH-724-10 | Ø 10,0 mm |
| CH-724-12 | Ø 12,0 mm |

NELSON

CH-724-03 - CH-724-12 21,0 cm, 8 1/4 "

Trocars

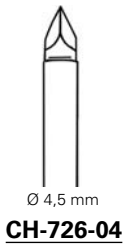

CARSTENS

CH-726-04 Ø 4,5 mm

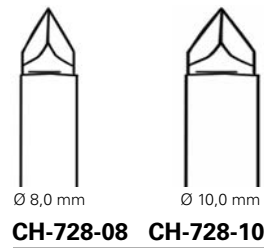
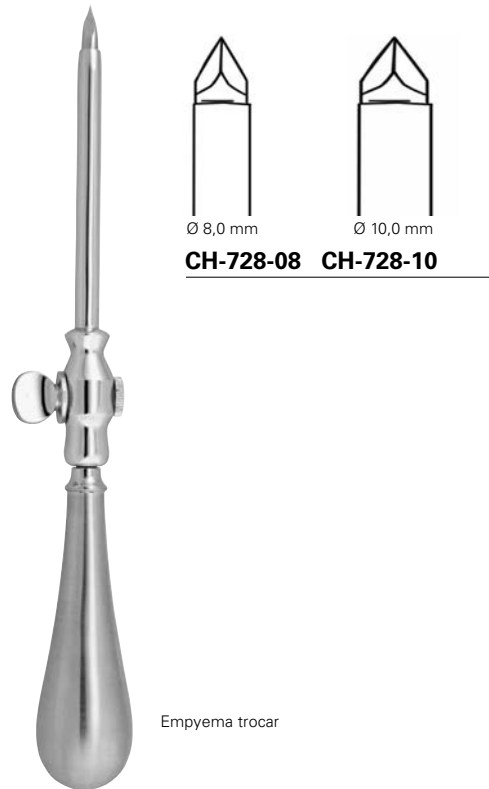

Empyema trocar

BUELAU

CH-728-08 - CH-728-10 21,0 cm, 9 ½ "

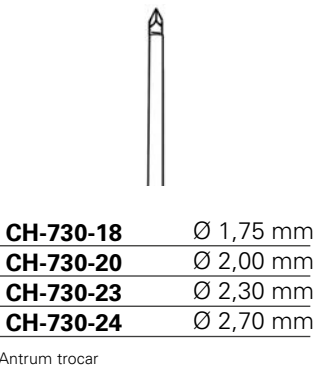
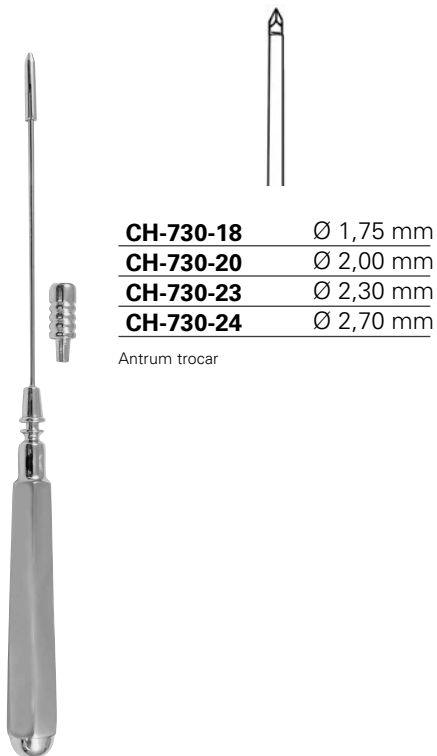

LICHTWITZ

CH-730-18 - CH-730-24 18,5 cm, 7 ¼ "

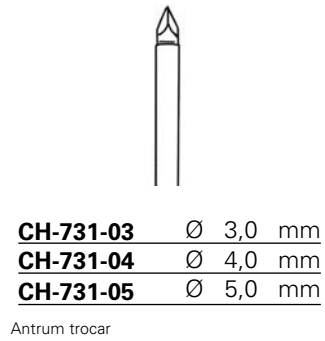
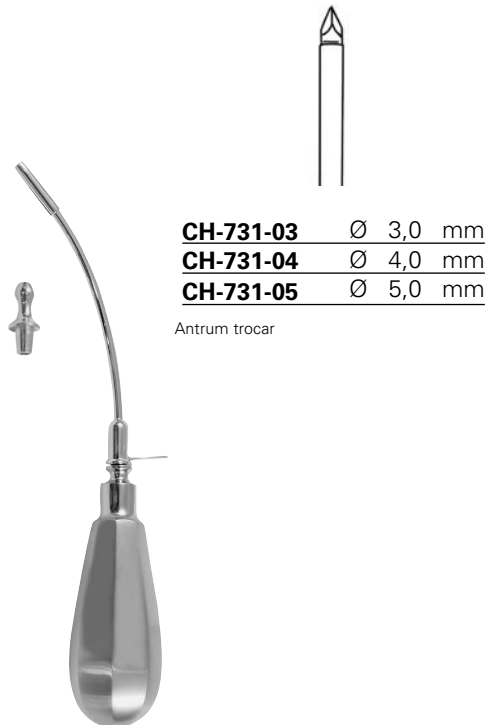

PIERCE

CH-731-03 - CH-731-05 15,0 cm, 6 "

Trocars



Antrum trocar

Ø 4,0 mm



KRAUSE

10-733-04 16,0 cm, 6 ¼"

Ø 5,5 mm

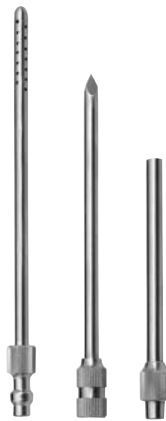

DUKE

10-734-05 11,0 cm, 4 ½"

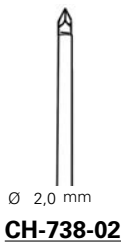

LANDAU

CH-738-02 Ø 2,0 mm

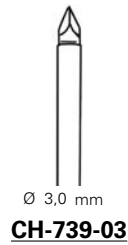

Antrum trocar

DOUGLAS

CH-739-03 14,0 cm, 5 ½"

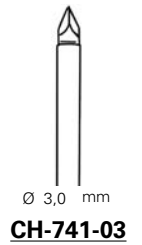

Antrum trocar

COAKLEY

CH-741-03 15,5 cm, 6"

Suction Tubes



YANKAUER

CH-911-01 27,0 cm, 10 3/4"



YANKAUER

CH-911-02 27,0 cm, 10 3/4"



Olive

YANKAUER

CH-911-31



BABY-YANKAUER

CH-911-03 21,0 cm, 8 1/4"



Olive

BABY-YANKAUER

CH-911-32



With stopcock and tube to be screwed off

WALTON-YANKAUER

CH-911-04 33,0 cm, 13"

Suction Tubes

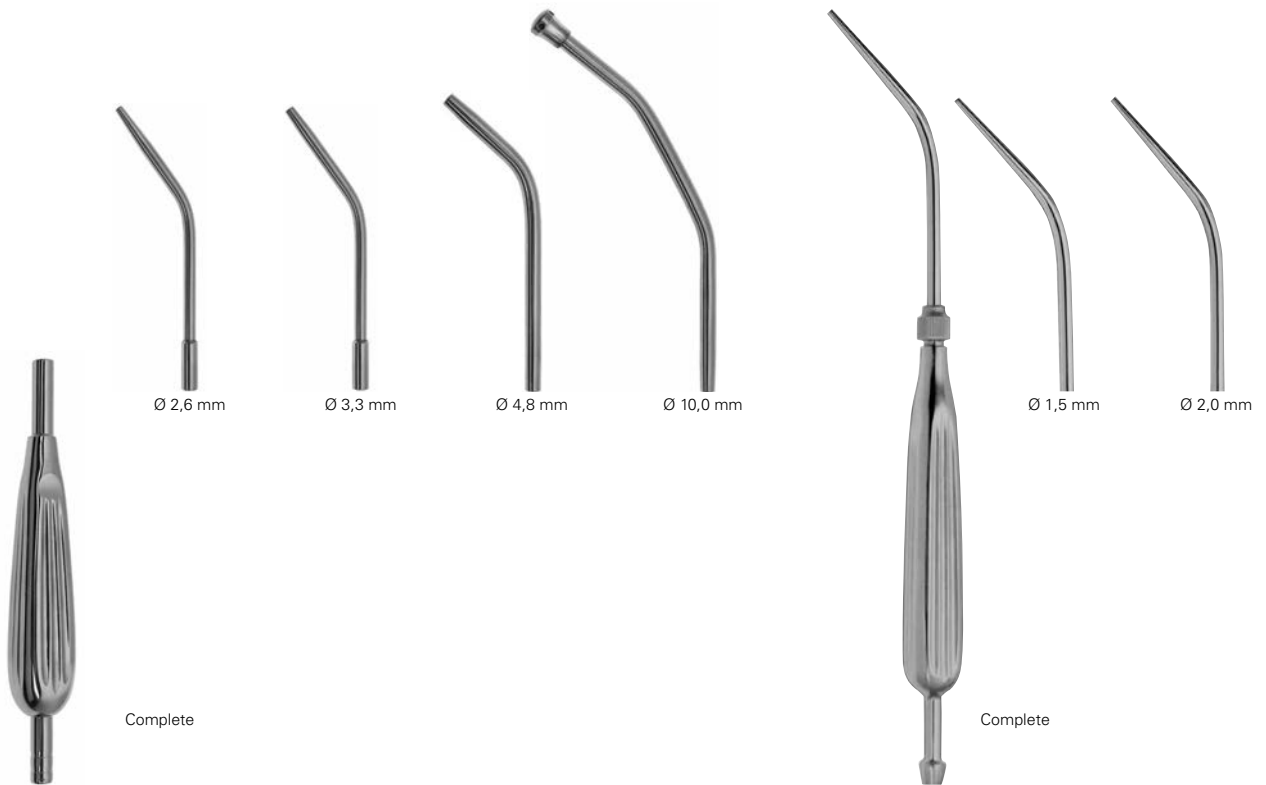

YANKAUER

CH-912-00 27,0 cm, 10 3/4"

COUPLAND

CH-913-00 26,0 cm, 10 1/4"



COUPLAND

CH-913-01 17,0 cm, 6 3/4"



COUPLAND

CH-913-15 - CH-913-35 10,0 cm, 4"

Ø 1,5 mm
CH-913-15

Ø 2,0 mm
CH-913-20

Ø 2,5 mm
CH-913-25

Ø 3,5 mm
CH-913-35

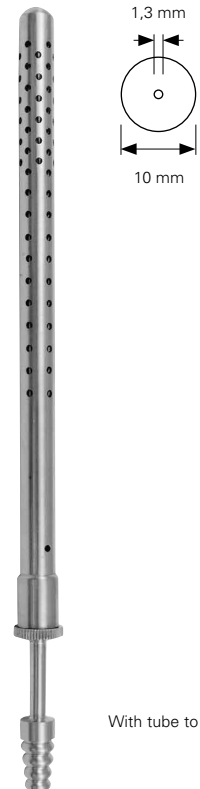

With tube to be screwed off

POOLE

CH-914-10 22,0 cm, 8 5/8"

Suction Tubes



WULLSTEIN

CH-900-00 14,0 cm, 5 1/2"

WULLSTEIN

CH-900-01 14,0 cm, 5 1/2"

WULLSTEIN

| | |
|------------------|----------|
| CH-900-04 | Ø 0,4 mm |
| CH-900-08 | Ø 0,8 mm |
| CH-900-06 | Ø 0,6 mm |

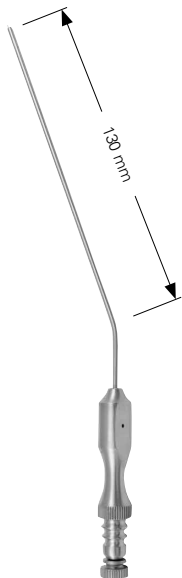

FRAZIER

| | |
|------------------|-----------|
| CH-902-06 | 6 Charr. |
| CH-902-07 | 7 Charr. |
| CH-902-08 | 8 Charr. |
| CH-902-09 | 9 Charr. |
| CH-902-10 | 10 Charr. |
| CH-902-11 | 11 Charr. |
| CH-902-12 | 12 Charr. |
| CH-902-15 | 15 Charr. |



PLESTER

| | |
|------------------|-----------|
| CH-903-05 | 5 Charr. |
| CH-903-06 | 6 Charr. |
| CH-903-07 | 7 Charr. |
| CH-903-08 | 8 Charr. |
| CH-903-09 | 9 Charr. |
| CH-903-10 | 10 Charr. |

Suction Tubes

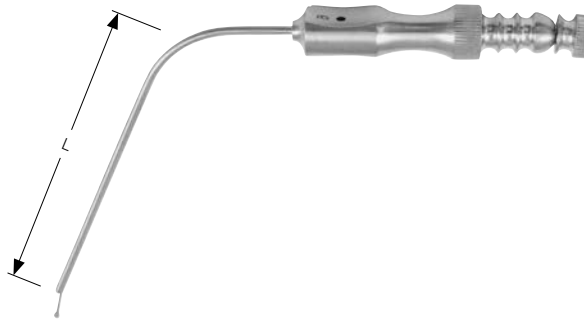

FERGUSSON

| Ø | Length 110 mm | Length 130 mm | Length 160 mm | Length 200 mm |
|-----------|------------------|------------------|------------------|------------------|
| 5 Charr. | CH-904-05 | CH-904-25 | CH-904-45 | CH-904-65 |
| 6 Charr. | CH-904-06 | CH-904-26 | CH-904-46 | CH-904-66 |
| 7 Charr. | CH-904-07 | | | |
| 8 Charr. | CH-904-08 | CH-904-28 | CH-904-48 | CH-904-68 |
| 9 Charr. | CH-904-09 | CH-904-29 | CH-904-49 | CH-904-69 |
| 10 Charr. | CH-904-10 | | | |
| 11 Charr. | CH-904-11 | | | |
| 12 Charr. | CH-904-12 | CH-904-32 | CH-904-52 | CH-904-72 |
| 15 Charr. | CH-904-15 | CH-904-35 | CH-904-55 | CH-904-75 |

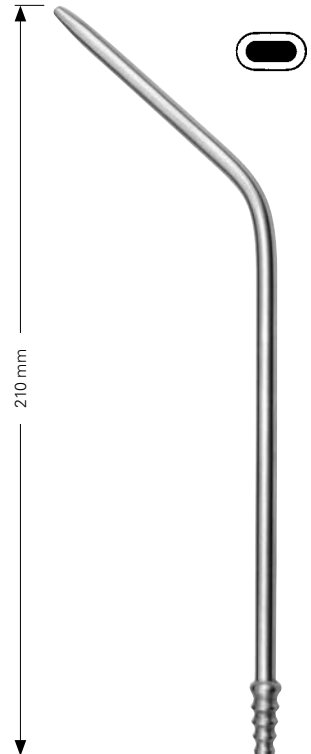
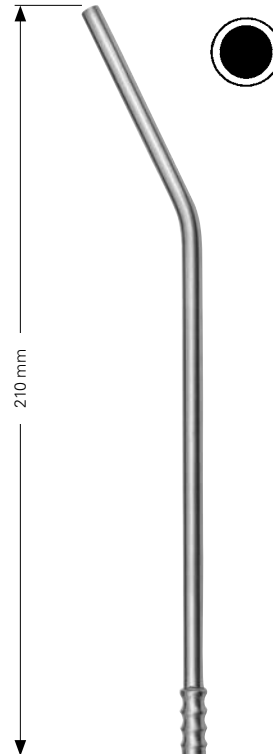
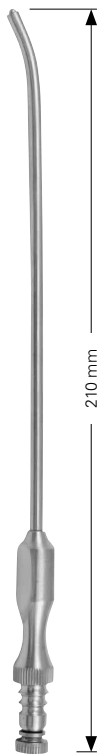

ADSON

CH-905-04 Ø 4,0 mm

NUBOER

CH-906-06 Ø 6,0 mm

NUBOER

CH-906-07 Ø 6,0 mm

Suction Tubes

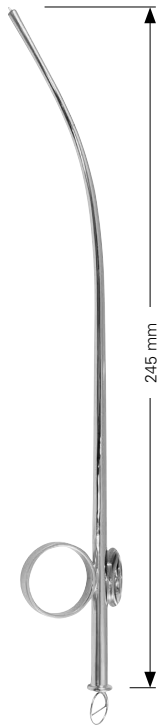

MAGILL

- CH-906-30** Ø 3,0 mm
- CH-906-35** Ø 3,4 mm
- CH-906-40** Ø 4,0 mm



Stilette

MAGILL

CH-906-99



insulated

FERGUSSON 85°

CH-907-00 Ø 4,0 mm



FERGUSSON 85°

- CH-907-01** 6 Charr.
- CH-907-02** 8 Charr.
- CH-907-03** 9 Charr.
- CH-907-04** 10 Charr.
- CH-907-05** 12 Charr.
- CH-907-06** 15 Charr.

Suction Tubes

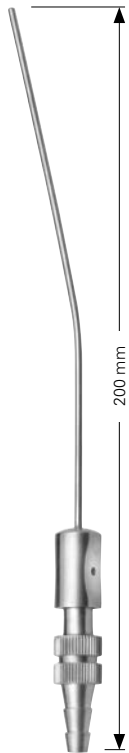

LEMPERT

- CH-908-07** Ø 2,0 mm
- CH-908-09** Ø 2,0 mm



FRAZIER

- CH-908-25** Ø 2,5 mm
- CH-908-30** Ø 3,0 mm

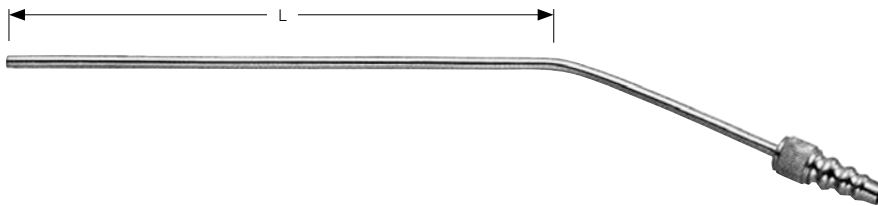

YASARGIL

| Ø | Length 130 mm | Length 150 mm | Length 180 mm | Length 220 mm |
|----------|------------------|------------------|------------------|------------------|
| Ø 1,5 mm | CH-910-15 | CH-910-16 | CH-910-17 | CH-910-18 |
| Ø 2,0 mm | CH-910-20 | CH-910-21 | CH-910-22 | CH-910-23 |
| Ø 2,5 mm | CH-910-24 | CH-910-25 | CH-910-26 | CH-910-27 |
| Ø 3,5 mm | CH-910-33 | CH-910-35 | CH-910-36 | CH-910-37 |
| Ø 4,5 mm | | | CH-910-45 | |

Suction Tubes



POOLE

CH-915-06 - CH-915-08 22,0 cm, 8 5/8"



COOLEY

CH-917-08 35,0 cm, 13 3/4"



COOLEY

CH-919-10 31,0 cm, 12 1/4"



COOLEY

CH-921-07 30,0 cm, 11 3/4"



COOLEY

CH-923-08 33,0 cm, 13"

Suction Tubes



DE BAKEY

CH-931-16 16,0 cm, 6 1/4"

DE BAKEY

CH-931-27 27,0 cm, 10 3/4"

DE BAKEY

CH-935-27 27,0 cm, 10 3/4"

FINSTERER

CH-937-32 32,0 cm, 12 1/2"

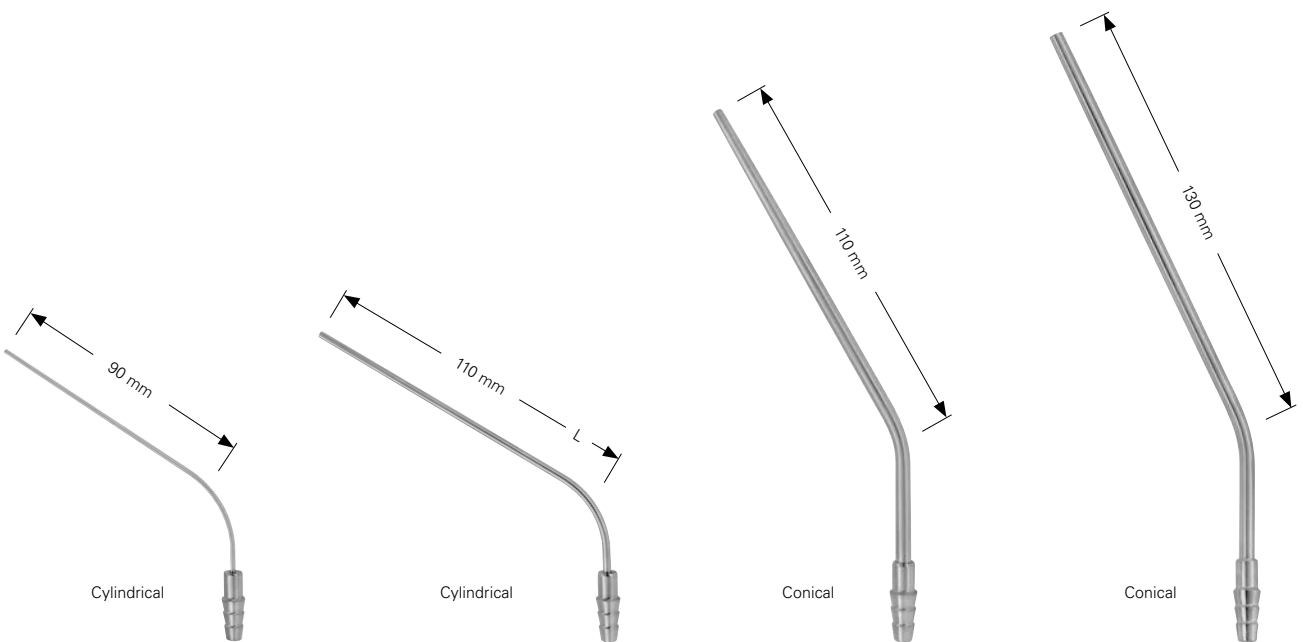

Cylindrical

Cylindrical

Conical

Conical

CH-940-10 Ø 1,0 mm
 CH-940-15 Ø 1,5 mm
 CH-940-20 Ø 2,0 mm

CH-940-25 Ø 2,5 mm
 CH-941-30 Ø 3,0 mm
 CH-941-40 Ø 4,0 mm
 CH-941-50 Ø 5,0 mm

CH-942-03 Ø 3,0 mm
 CH-942-04 Ø 3,5 mm

CH-942-05 Ø 4,5 mm

Suction Tubes

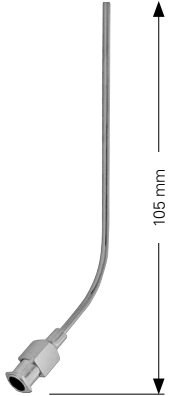

Suction handle with finger cut off

ROSEN

| | |
|-----------|----------|
| CH-944-05 | Ø 0,5 mm |
| CH-944-07 | Ø 0,7 mm |
| CH-944-08 | Ø 0,8 mm |
| CH-944-10 | Ø 1,0 mm |
| CH-944-12 | Ø 1,2 mm |
| CH-944-14 | Ø 1,4 mm |
| CH-944-15 | Ø 1,5 mm |
| CH-944-18 | Ø 1,8 mm |
| CH-944-20 | Ø 2,0 mm |
| CH-944-25 | Ø 2,5 mm |



CH-944-02 6,0 cm, 2 3/8"



Suction and Irrigation Instruments

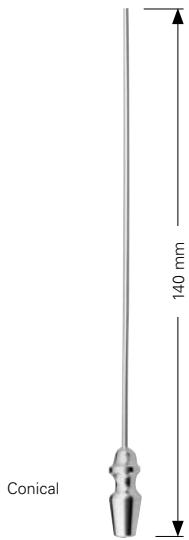

WULLSTEIN

CH-946-01 \varnothing 1,5 mm

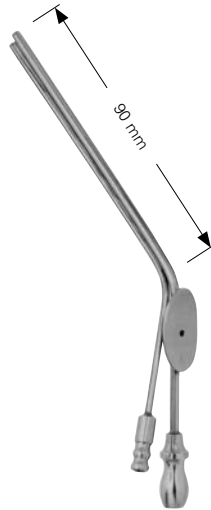

HOUSE

- CH-947-07** \varnothing 0,9 x 0,7 mm

- CH-947-09** \varnothing 1,2 x 0,9 mm

- CH-947-12** \varnothing 1,5 x 1,2 mm

- CH-947-18** \varnothing 1,8 x 1,8 mm

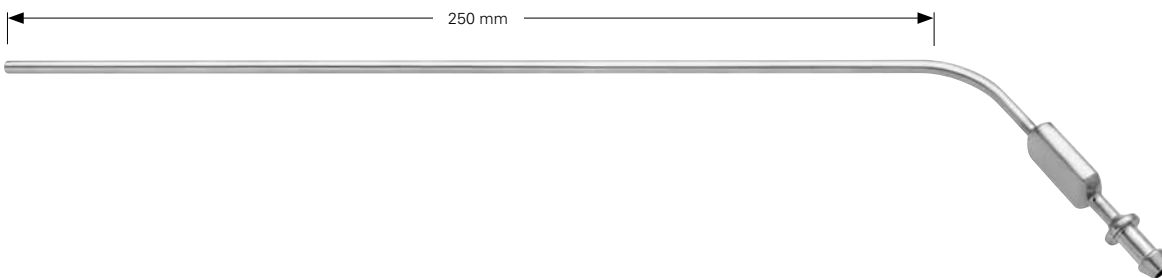

- CH-951-20** \varnothing 2,0 mm

- CH-951-25** \varnothing 2,5 mm

- CH-951-30** \varnothing 3,0 mm

Suction and Irrigation Instruments



Coagulation suction tube, insulated Tubo



CH-953-10 10,0 cm, 4 "

Antrum trocar

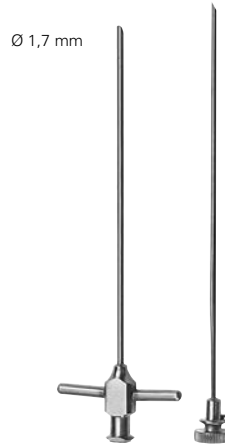

LICHTWITZ

CH-955-00 11,0 cm, 4 3/8 "

Antrum irrigation cannulas

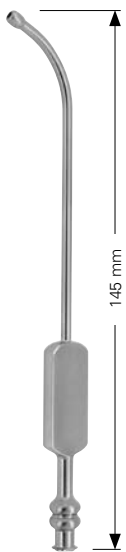

EICKEN

- CH-957-25** Ø 2,5 mm
- CH-957-30** Ø 3,0 mm
- CH-957-40** Ø 4,0 mm

Antrum irrigation cannulas

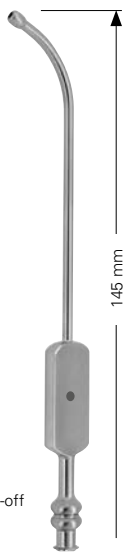

EICKEN

- CH-957-26** Ø 2,5 mm
- CH-957-31** Ø 3,0 mm
- CH-957-41** Ø 4,0 mm

Antrum irrigation cannulas

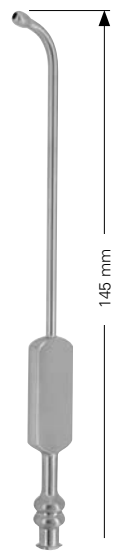

EICKEN

- CH-958-25** Ø 2,5 mm
- CH-958-30** Ø 3,0 mm
- CH-958-40** Ø 4,0 mm

Antrum irrigation cannulas

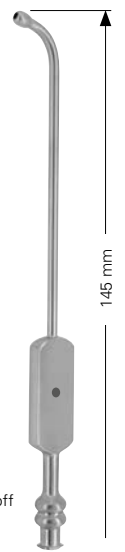

EICKEN

- CH-958-26** Ø 2,5 mm
- CH-958-31** Ø 3,0 mm
- CH-958-41** Ø 4,0 mm

Suction and Irrigation Instruments

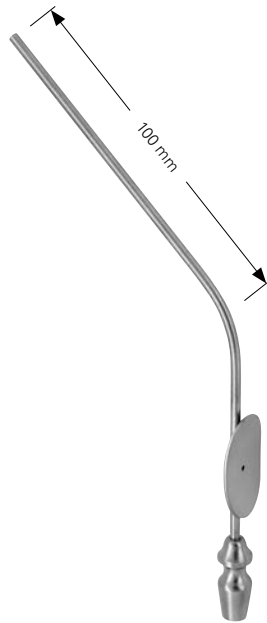
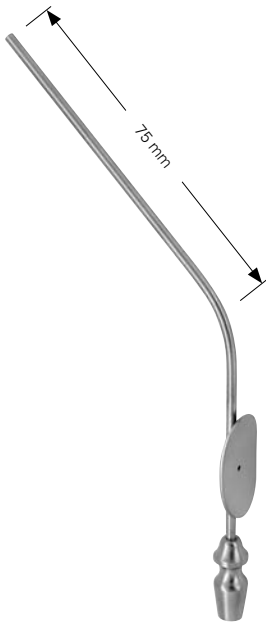

BARON

| | |
|------------------|----------|
| CH-962-03 | 3 Charr. |
| CH-962-5 | 5 Charr. |
| CH-962-07 | 7 Charr. |

BARON

| | |
|------------------|----------|
| CH-963-03 | 3 Charr. |
| CH-963-05 | 5 Charr. |
| CH-963-07 | 7 Charr. |

| | |
|------------------|----------|
| CH-963-03 | 3 Charr. |
| CH-9623-5 | 5 Charr. |
| CH-963-07 | 7 Charr. |

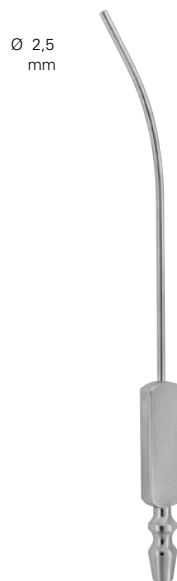
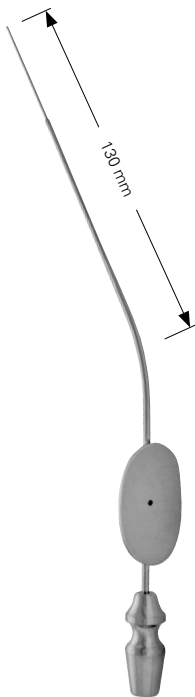

Suction Cannula tips for CH-964-00



SCHUHKNECH

| | |
|------------------|----------|
| CH-963-20 | Ø 1,0 mm |
| CH-964-24 | Ø 0,5 mm |

ZOELLNER

| | |
|------------------|--------------|
| CH-964-00 | 15,0 cm, 6 " |
|------------------|--------------|

ZOELLNER

| | |
|-------------------|----------|
| CH-964-05 | Ø 0,5 mm |
| CH-964-07 | Ø 0,7 mm |
| CH-964-09 | Ø 0,9 mm |
| CH-964-012 | Ø 01,2mm |

Suction and Irrigation Instruments

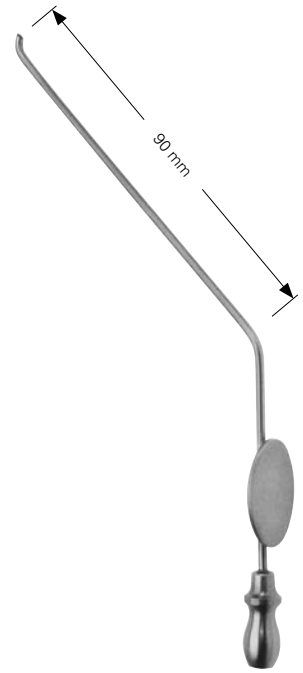
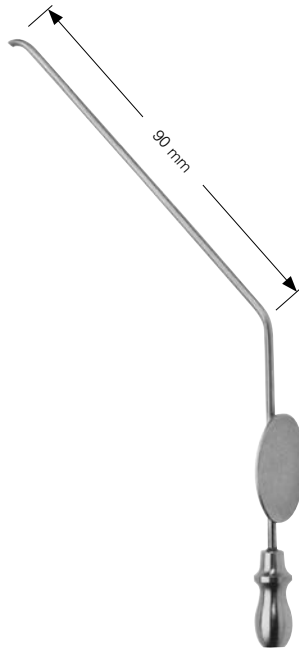
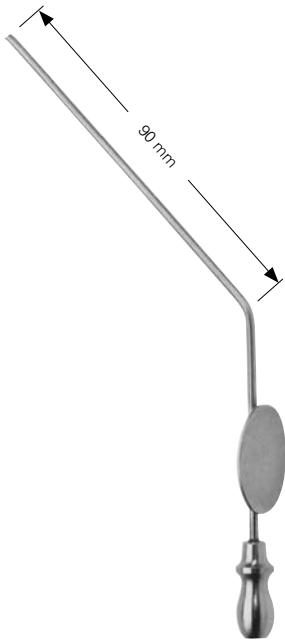

VERHOEVEN 45°

| | |
|------------------|----------|
| CH-965-12 | Ø 1,2 mm |
| CH-965-15 | Ø 1,5 mm |
| CH-965-20 | Ø 2,0 mm |
| CH-965-30 | Ø 3,0 mm |

VERHOEVEN 45°

| | |
|------------------|----------|
| CH-966-12 | Ø 1,2 mm |
| CH-966-15 | Ø 1,5 mm |
| CH-966-20 | Ø 2,0 mm |
| CH-966-30 | Ø 3,0 mm |

VERHOEVEN 45°

| | |
|------------------|----------|
| CH-967-12 | Ø 1,2 mm |
| CH-967-15 | Ø 1,5 mm |
| CH-967-20 | Ø 2,0 mm |
| CH-967-30 | Ø 3,0 mm |



Scalpel Handles



BAYHA I Fig. 1
CH-100-01 13,0 cm, 5 1/8"



BAYHA I Fig. 2
CH-100-02 13,0 cm, 5 1/8"



BAYHA I Fig. 3
CH-100-03 20,0 cm, 8"



BAYHA I Fig. 4
CH-100-04 16,0 cm, 6 1/4"



BAYHA I Fig. 5
CH-100-05 15,0 cm, 6"



Fig. 10-15C

Nr. 3
CH-103-01 12,0 cm, 4 3/4"



Fig. 10-15C

Nr. 3
CH-103-03 12,0 cm, 4 3/4"



Fig. 10-15C

Nr. 3 L
CH-103-04 21,0 cm, 8 1/4"

Scalpel Handles



Fig. 10-15C

Nr. 3 L

CH-103-05 20,5 cm, 8"



Fig. 10-15C

Nr. 7

CH-103-06 16,0 cm, 6 1/4"



Fig. 10-15C

Nr. 7 K

CH-103-07 13,0 cm, 5"



Fig. 10-15C

Nr. 3

CH-103-08 21,5 cm, 8 1/2"



Fig. 10-15C

Nr. 3 L

CH-103-09 21,5 cm, 8 1/2"



Fig. 10-15C

Nr. 3

CH-103-10 12,5 cm, 5"



Fig. 10-15C

Nr. 3

CH-103-11 15,5 cm, 6 1/8"



Fig. 10-15C

Nr. 3

CH-103-12 14,5 cm, 5 3/4"

Scalpel Handles



Fig. 10-15C

Nr. 3
CH-103-13 14,5 cm, 5 3/4"



Fig. 10-15C

Nr. 3
CH-103-14 15,0 cm, 6"



Fig. 10-36D

Nr. 3 + 4
CH-103-34 16,0 cm, 6 1/4"



Fig. 18-36D

Nr. 4
CH-104-01 13,5 cm, 5 1/4"



Fig. 18-36D

Nr. 4 L
CH-104-04 21,0 cm, 8 1/4"



Fig. 18-36D

Nr. 4 L
CH-104-05 21,0 cm, 8 1/4"



Fig. 18-36D

Nr. 4
CH-104-08 21,5 cm, 8 1/2"



Fig. 18-36D

Nr. 4
CH-104-10 13,5 cm, 5 1/4"

Scalpel Handles, Blade Holders, Blade Breakers



Fig. 10-15C



Fig. 18-36D



Fig. 18-36D



Packing unit: 10 pieces

Razor blades, breakable



Nr. 5

CH-105-01 16,0 cm, 6 ¼"

COLLIN I Nr. 8

CH-108-00 13,5 cm, 5 ¼"

COLLIN I Nr. 9

CH-109-00 14,5 cm, 5 ¾" **CH-116-00**



TROUTMAN-CHRIS

CH-110-10 9,0 cm, 3 ½"



TROUTMAN-CHRIS

CH-111-10 9,0 cm, 3 ½"



CH-112-11 11,0 cm, 4 ¾"



CASTROVIEJO

CH-114-13 13,0 cm, 5 ⅛"

Scalpel Blades, Sterile



CH-199-00 Fig. 10 - 36D

Scalpel-Blade Remover



Packing unit: 100 pieces



Fig. 10
CH-153-10



Fig. 11
CH-153-11

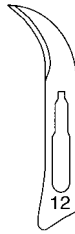

Fig. 12
CH-153-12

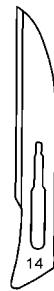

Fig. 14
CH-153-14



Fig. 15
CH-153-15



Fig. 15c
CH-153-55



Fig. 18
CH-154-18



Fig. 19
CH-154-19



Fig. 20
CH-154-20



Fig. 21
CH-154-21



Fig. 22
CH-154-22



Fig. 23
CH-154-23

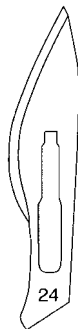

Fig. 24
CH-154-24



Fig. 25
CH-154-25

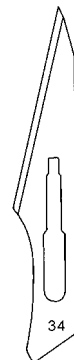

Fig. 34
CH-154-34

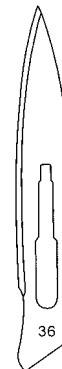

Fig. 36
CH-154-36

Disposable Scalpels, Sterile



Packing unit: 10 pieces



Fig. 10
CH-253-10



Fig. 11
CH-253-11



Fig. 12
CH-253-12



Fig. 13
CH-253-13



Fig. 15
CH-253-15



Fig. 15C
CH-253-51



Fig. 18
CH-254-18



Fig. 19
CH-254-19



Fig. 20
CH-254-20



Fig. 21
CH-254-21



Fig. 22
CH-254-22



Fig. 23
10-254-23



Fig. 24
CH-254-24

Mini Scalpel Blades, Sterile, Scalpel Handles

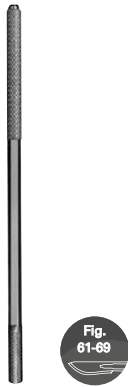

Fig. 61-69

CH-260-10 10,0 cm, 4"

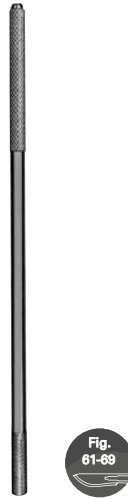

Fig. 61-69

CH-260-13 13,0 cm, 5 1/8"

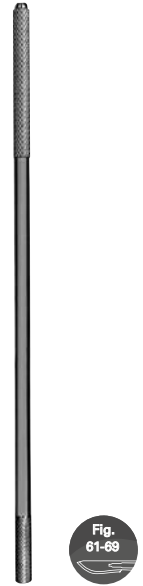

Fig. 61-69

CH-260-15 15,5 cm, 6 1/8"



Packing unit: 10 pieces



FIG. 61
CH-265-61

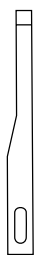

FIG. 62
CH-265-62



FIG. 62S
CH-265-63



FIG. 64
CH-265-64



FIG. 65
CH-265-65

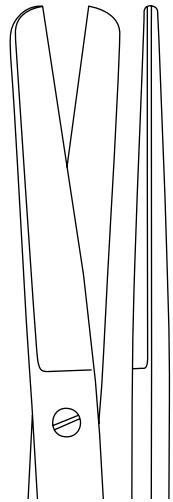

FIG. 67
CH-265-67



FIG. 69
CH-265-69

Surgical Scissors



STANDARD Fig. 1

| | |
|------------------|--|
| CH-000-10 | 10,0 cm, 4 " |
| CH-000-11 | 11,0 cm, 4 ³ / ₈ " |
| CH-000-13 | 13,0 cm, 5 ¹ / ₈ " |
| CH-000-14 | 14,0 cm, 5 ¹ / ₂ " |
| CH-000-15 | 15,0 cm, 6 " |
| CH-000-16 | 16,0 cm, 6 ¹ / ₄ " |
| CH-000-17 | 17,0 cm, 6 ³ / ₄ " |
| CH-000-18 | 18,0 cm, 7 " |
| CH-000-20 | 20,0 cm, 8 " |



STANDARD Fig. 1

| | |
|------------------|--|
| CH-001-10 | 10,0 cm, 4 " |
| CH-001-11 | 11,0 cm, 4 ³ / ₈ " |
| CH-001-13 | 13,0 cm, 5 ¹ / ₈ " |
| CH-001-14 | 14,0 cm, 5 ¹ / ₂ " |
| CH-001-15 | 15,0 cm, 6 " |
| CH-001-16 | 16,0 cm, 6 ¹ / ₄ " |
| CH-001-17 | 17,0 cm, 6 ³ / ₄ " |
| CH-001-18 | 18,0 cm, 7 " |
| CH-001-20 | 20,0 cm, 8 " |

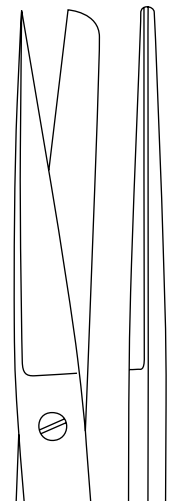

STANDARD Fig. 2

| | |
|--------------------|--|
| CH-002-10 | 10,0 cm, 4 " |
| CH-002-11 | 11,0 cm, 4 ³ / ₈ " |
| CH-002-13 | 13,0 cm, 5 ¹ / ₈ " |
| CH-002-14 | 14,0 cm, 5 ¹ / ₂ " |
| CH-002-14 W | 14,0 cm, 5 ¹ / ₂ " |
| CH-002-15 | 15,0 cm, 6 " |
| CH-002-16 | 16,0 cm, 6 ¹ / ₄ " |
| CH-002-17 | 17,0 cm, 6 ³ / ₄ " |
| CH-002-18 | 18,0 cm, 7 " |
| CH-002-20 | 20,0 cm, 8 " |

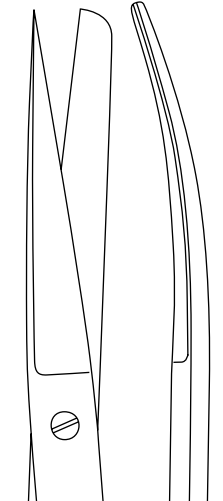

STANDARD Fig. 2

| | |
|------------------|--|
| CH-003-10 | 10,0 cm, 4 " |
| CH-003-11 | 11,0 cm, 4 ³ / ₈ " |
| CH-003-13 | 13,0 cm, 5 ¹ / ₈ " |
| CH-003-14 | 14,0 cm, 5 ¹ / ₂ " |
| CH-003-15 | 15,0 cm, 6 " |
| CH-003-16 | 16,0 cm, 6 ¹ / ₄ " |
| CH-003-17 | 17,0 cm, 6 ³ / ₄ " |
| CH-003-18 | 18,0 cm, 7 " |
| CH-003-20 | 20,0 cm, 8 " |

W = Wave Cut

Surgical Scissors

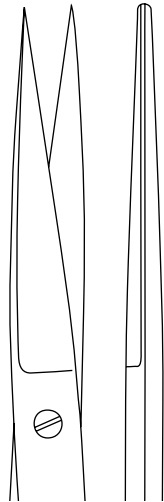

STANDARD Fig. 3

| | |
|------------------|------------------|
| CH-004-10 | 10,0 cm, 4 " |
| CH-004-11 | 11,0 cm, 4 3/8 " |
| CH-004-13 | 13,0 cm, 5 1/8 " |
| CH-004-14 | 14,0 cm, 5 1/2 " |
| CH-004-15 | 15,0 cm, 6 " |
| CH-004-16 | 16,0 cm, 6 1/4 " |
| CH-004-17 | 17,0 cm, 6 3/4 " |
| CH-004-18 | 18,0 cm, 7 " |
| CH-004-20 | 20,0 cm, 8 " |



STANDARD Fig. 3

| | |
|------------------|------------------|
| CH-005-10 | 10,0 cm, 4 " |
| CH-005-11 | 11,0 cm, 4 3/8 " |
| CH-005-13 | 13,0 cm, 5 1/8 " |
| CH-005-14 | 14,0 cm, 5 1/2 " |
| CH-005-15 | 15,0 cm, 6 " |
| CH-005-16 | 16,0 cm, 6 1/4 " |
| CH-005-17 | 17,0 cm, 6 3/4 " |
| CH-005-18 | 18,0 cm, 7 " |
| CH-005-20 | 20,0 cm, 8 " |

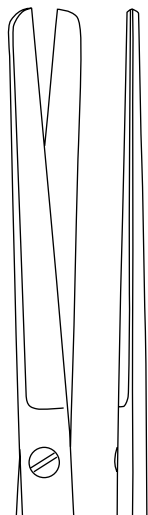

CH-010-13
CH-010-14

Delicate pattern

GRAZIL Fig. 1

| | |
|------------------|------------------|
| CH-010-13 | 13,0 cm, 5 1/8 " |
| CH-010-14 | 14,0 cm, 5 1/2 " |



CH-011-13
CH-011-14

Delicate pattern

GRAZIL Fig. 1

| | |
|------------------|------------------|
| CH-011-13 | 13,0 cm, 5 1/8 " |
| CH-011-14 | 14,0 cm, 5 1/2 " |

Surgical Scissors

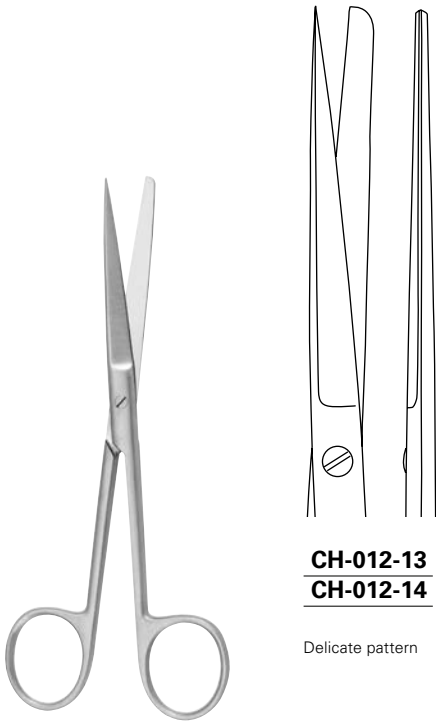

CH-012-13
CH-012-14

Delicate pattern

GRAZIL Fig. 2

CH-012-13 13,0 cm, 5 1/8"

CH-012-14 14,0 cm, 5 1/2"

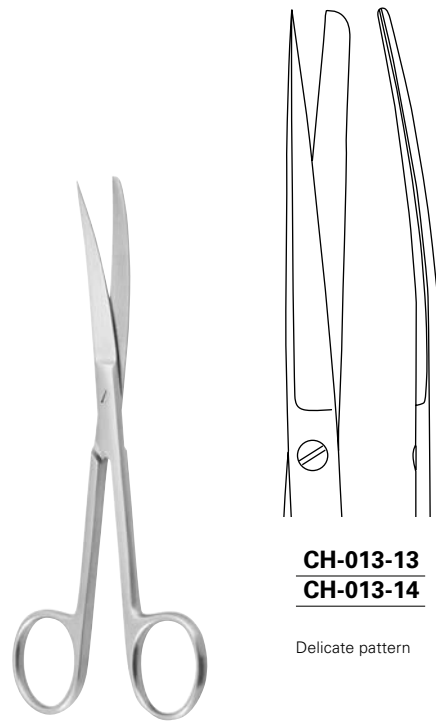

CH-013-13
CH-013-14

Delicate pattern

GRAZIL Fig. 2

CH-013-13 13,0 cm, 5 1/8"

CH-013-14 14,0 cm, 5 1/2"

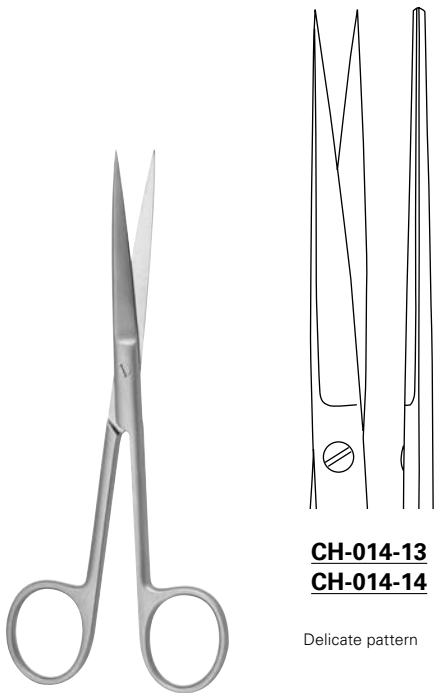

CH-014-13
CH-014-14

Delicate pattern

GRAZIL Fig. 3

CH-014-13 13,0 cm, 5 1/8"

CH-014-14 14,0 cm, 5 1/2"

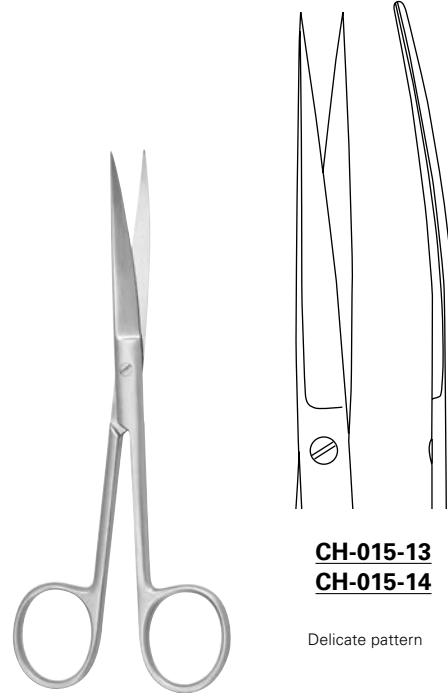

CH-015-13
CH-015-14

Delicate pattern

GRAZIL Fig. 3

CH-015-13 13,0 cm, 5 1/8"

CH-015-14 14,0 cm, 5 1/2"

Surgical Scissors

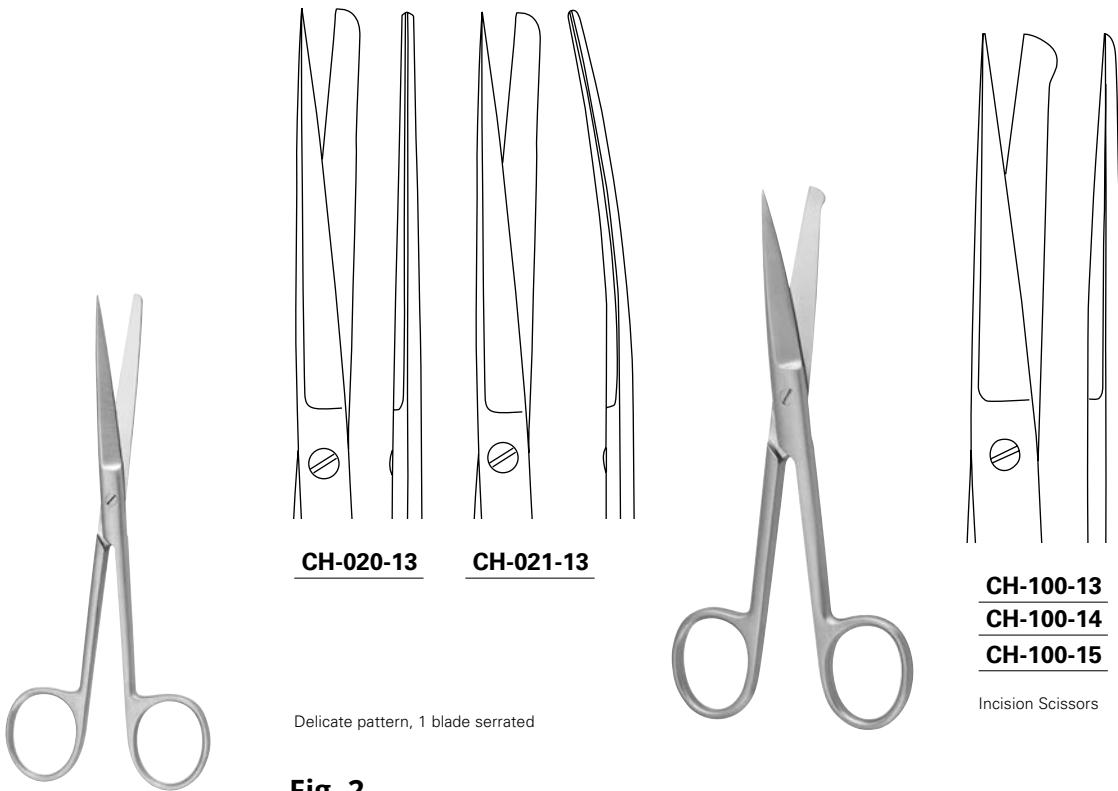

Fig. 2

GRAZIL

CH-020-13 - CH-021-13 13,0 cm, 5 1/8"

CH-100-13 13,0 cm, 5 1/8"
CH-100-14 14,0 cm, 5 1/2"
CH-100-15 15,0 cm, 6"



Dissecting Scissors

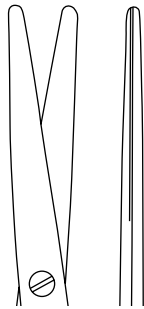
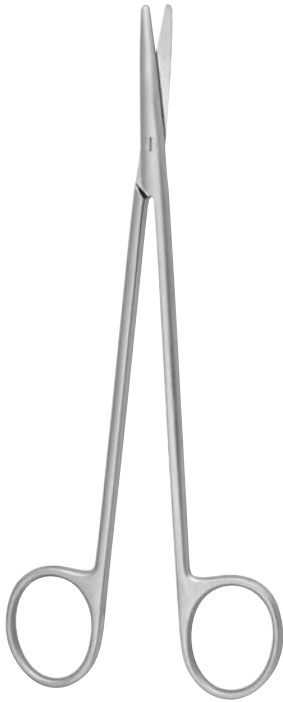

METZENBAUM

| | |
|------------------|------------------|
| CH-200-14 | 14,0 cm, 5 1/2" |
| CH-200-18 | 18,0 cm, 7" |
| CH-200-20 | 20,0 cm, 8" |
| CH-200-23 | 23,0 cm, 9" |
| CH-200-25 | 25,0 cm, 9 3/4" |
| CH-200-28 | 28,0 cm, 11" |
| CH-200-30 | 30,0 cm, 12" |
| CH-200-36 | 36,0 cm, 14 1/4" |

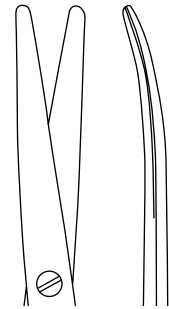
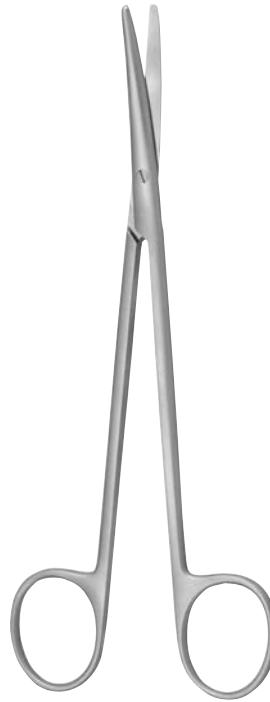

METZENBAUM

| | |
|------------------|------------------|
| CH-201-14 | 14,0 cm, 5 1/2" |
| CH-201-18 | 18,0 cm, 7" |
| CH-201-20 | 20,0 cm, 8" |
| CH-201-23 | 23,0 cm, 9" |
| CH-201-25 | 25,0 cm, 9 3/4" |
| CH-201-28 | 28,0 cm, 11" |
| CH-201-30 | 30,0 cm, 12" |
| CH-201-36 | 36,0 cm, 14 1/4" |

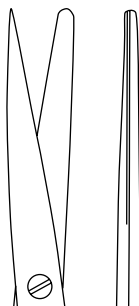
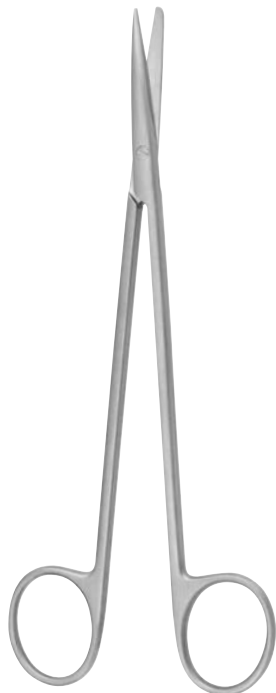

CH-202-14
CH-202-18
CH-202-20

METZENBAUM

| | |
|------------------|-----------------|
| CH-202-14 | 14,0 cm, 5 1/2" |
| CH-202-18 | 18,0 cm, 7" |
| CH-202-20 | 20,0 cm, 8" |

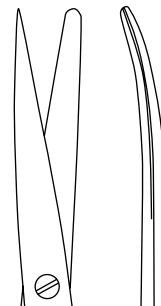
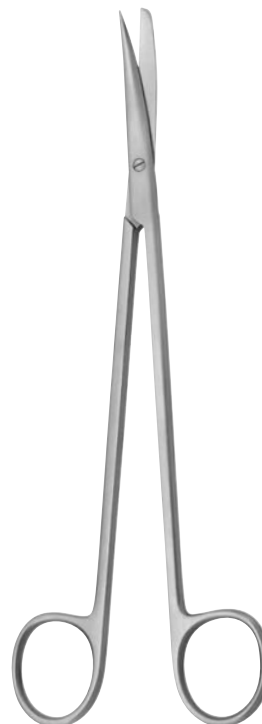

CH-203-14
CH-203-18
CH-203-20

METZENBAUM

| | |
|------------------|-----------------|
| CH-203-14 | 14,0 cm, 5 1/2" |
| CH-203-18 | 18,0 cm, 7" |
| CH-203-20 | 20,0 cm, 8" |

Dissecting Scissors

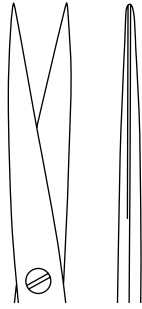
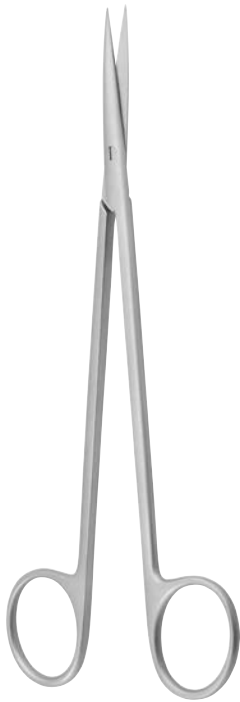

- CH-204-14**
- CH-204-18**
- CH-204-20**
- CH-204-23**

METZENBAUM

| | |
|------------------|------------------|
| CH-204-14 | 14,0 cm, 5 1/2 " |
| CH-204-18 | 18,0 cm, 7 " |
| CH-204-20 | 20,0 cm, 8 " |
| CH-204-23 | 23,0 cm, 9 " |

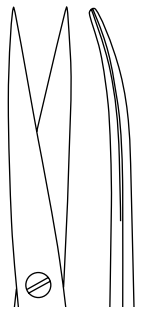

METZENBAUM

| | |
|------------------|------------------|
| CH-205-14 | 14,0 cm, 5 1/2 " |
|------------------|------------------|

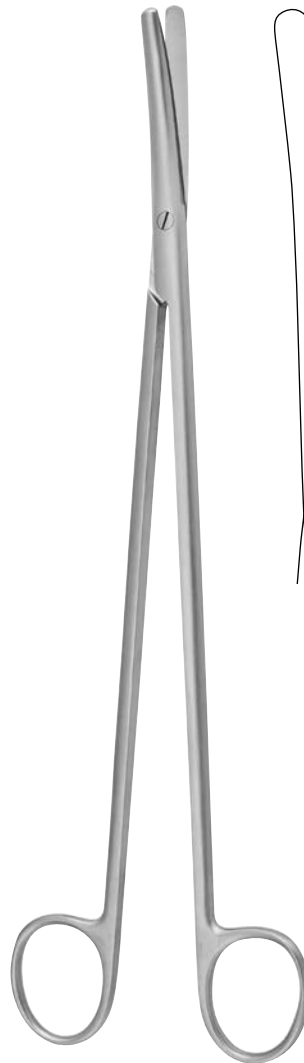

METZENBAUM

| | |
|------------------|---------------|
| CH-209-28 | 28,0 cm, 11 " |
|------------------|---------------|

Dissecting Scissors

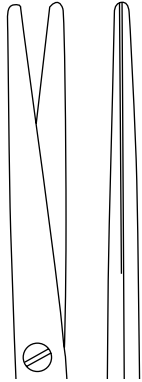

METZENBAUM-FINO

| | |
|------------------|-----------------|
| CH-210-12 | 12,0 cm, 4 3/4" |
| CH-210-14 | 14,0 cm, 5 1/2" |
| CH-210-18 | 18,0 cm, 7" |
| CH-210-20 | 20,0 cm, 8" |
| CH-210-23 | 23,0 cm, 9" |
| CH-210-25 | 25,0 cm, 9 3/4" |

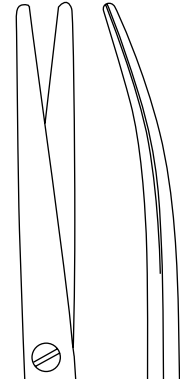

METZENBAUM-FINO

| | |
|------------------|-----------------|
| CH-211-12 | 12,0 cm, 4 3/4" |
| CH-211-14 | 14,0 cm, 5 1/2" |
| CH-211-18 | 18,0 cm, 7" |
| CH-211-20 | 20,0 cm, 8" |
| CH-211-23 | 23,0 cm, 9" |
| CH-211-25 | 25,0 cm, 9 3/4" |
| CH-211-28 | 28,0 cm, 11" |
| CH-211-30 | 30,0 cm, 12" |

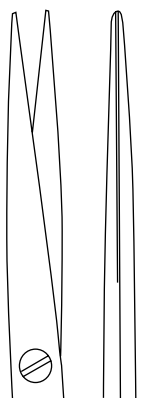
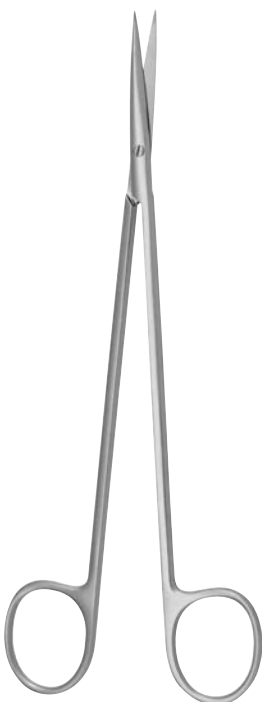

METZENBAUM-FINO

| | |
|------------------|-----------------|
| CH-214-14 | 14,0 cm, 5 1/2" |
| CH-214-18 | 18,0 cm, 7" |
| CH-214-20 | 20,0 cm, 8" |
| CH-214-23 | 23,0 cm, 9" |

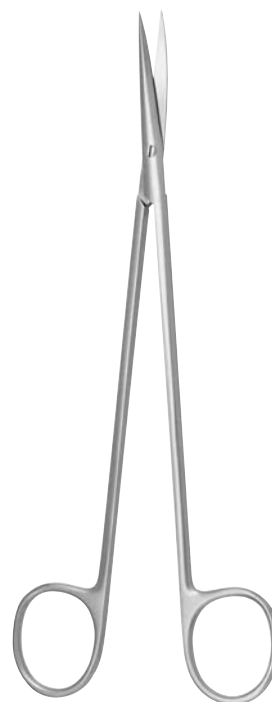

METZENBAUM-FINO

| | |
|------------------|-----------------|
| CH-215-14 | 14,0 cm, 5 1/2" |
| CH-215-18 | 18,0 cm, 7" |
| CH-215-20 | 20,0 cm, 8" |
| CH-215-23 | 23,0 cm, 9" |

Dissecting Scissors

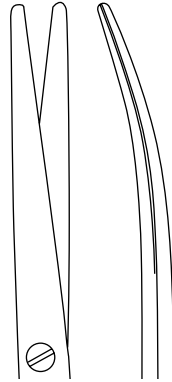
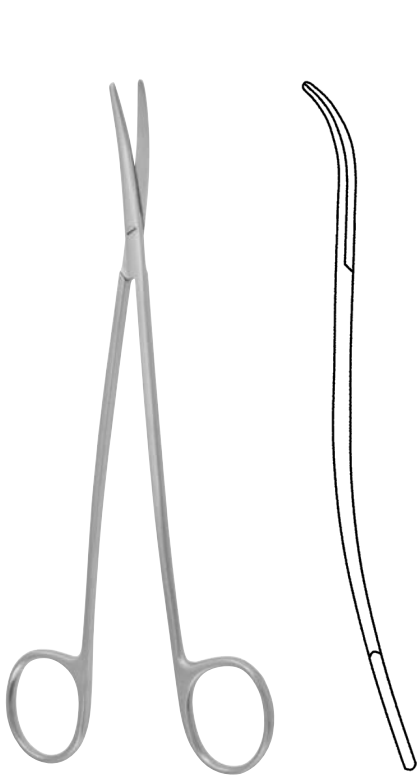

METZENBAUM-FINO-S

| | |
|------------------|-----------------|
| CH-221-14 | 14,0 cm, 5 1/2" |
| CH-221-18 | 18,0 cm, 7" |
| CH-221-20 | 20,0 cm, 8" |
| CH-221-23 | 23,0 cm, 9" |
| CH-221-25 | 25,0 cm, 9 3/4" |

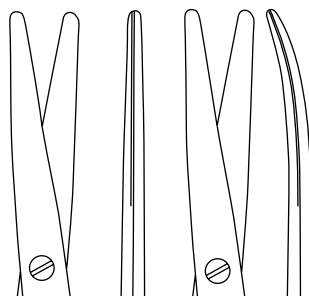

CH-226-15

CH-227-15

Short blades

Short blades

METZENBAUM

CH-226-15 - CH-227-15 15,0 cm, 6"

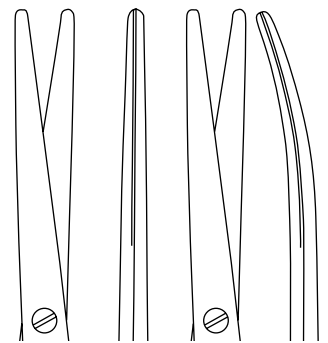

CH-228-11

CH-229-11

METZENBAUM-BABY

CH-228-11 - CH-229-11 11,0 cm, 4 3/8"

Dissecting Scissors

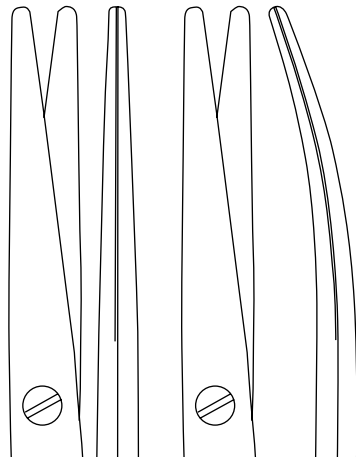

CH-230-16

CH-231-16

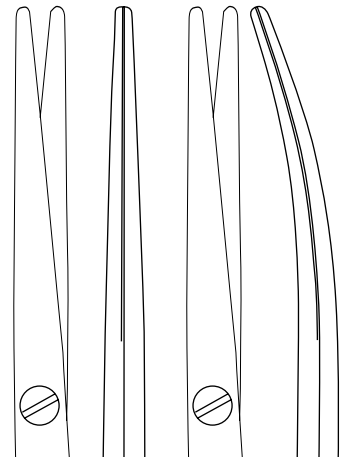

CH-232-16

CH-233-16

LEXER

CH-230-16 - CH-231-16 16,0 cm, 6 ¼"

LEXER-FINO

CH-232-16 - CH-233-16 16,0 cm, 6 ¼"

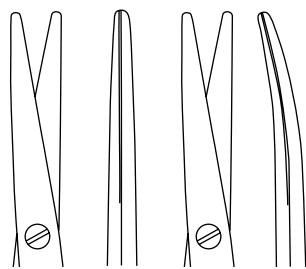

CH-234-10

CH-235-10

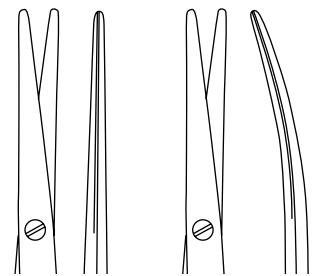

CH-236-09
CH-236-11

CH-237-09
CH-237-11

LEXER-BABY

CH-234-10 - CH-235-10 10,0 cm, 4"

STRABISMUS

CH-236-09 - CH-237-09 9,0 cm, 3 ½"
CH-236-11 - CH-237-11 11,0 cm, 4 ⅜"

Delicate Surgical Scissors

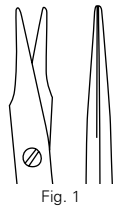

Fig. 1

CH-432-10
CH-432-11

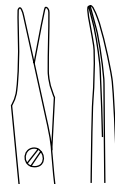

Fig. 1

CH-433-10
CH-433-11



Fig. 3

CH-434-10
CH-434-11



Fig. 3

CH-435-10
CH-435-11

STEVENS

CH-432-10 - CH-435-10 10,0 cm, 4 "
CH-432-11 - CH-435-11 11,0 cm, 4 3/8 "



IRIS

CH-436-09 9,0 cm, 3 1/2 "
CH-436-10 10,0 cm, 4 "
CH-436-11 11,0 cm, 4 3/8 "

IRIS

CH-437-09 9,0 cm, 3 1/2 "
CH-437-10 10,0 cm, 4 "
CH-437-11 11,0 cm, 4 3/8 "

Delicate Surgical Scissors

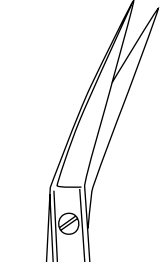
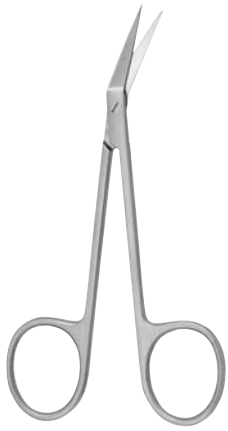

CH-438-11



CH-439-11



CH-439-09

IRIS

CH-438-11 - CH-439-11 11,0 cm, 4 3/8"

O'BRIEN

CH-439-09 9,0 cm, 3 1/2"

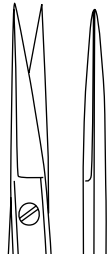

IRIS STANDARD

CH-440-09 9,0 cm, 3 1/2"
CH-440-10 10,0 cm, 4"
CH-440-11 11,0 cm, 4 3/8"
CH-440-12 12,0 cm, 4 3/4"



IRIS STANDARD

CH-441-09 9,0 cm, 3 1/2"
CH-441-10 10,0 cm, 4"
CH-441-11 11,0 cm, 4 3/8"
CH-441-12 12,0 cm, 4 3/4"



Delicate Surgical Scissors

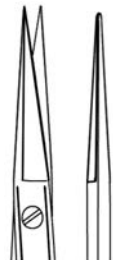

CH-442-10
CH-442-11



CH-443-10
CH-443-11



CH-444-11



CH-445-11

IRIS-FINO

CH-442-10 - CH-443-10 10,0 cm, 4"
CH-442-11 - CH-443-11 11,0 cm, 4 3/8"

IRIS-ANATOMY

CH-444-11 - CH-445-11 11,0 cm, 4 3/8"



CH-446-08
CH-446-09



CH-447-08
CH-447-09

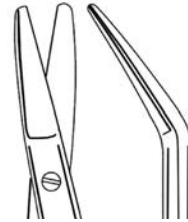

BONN

CH-446-08 - CH-447-08 8,0 cm, 3 1/8"
CH-446-09 - CH-447-09 9,0 cm, 3 1/2"

GRAEFE

CH-449-10 9,5 cm, 3 3/4"



Delicate Surgical Scissors

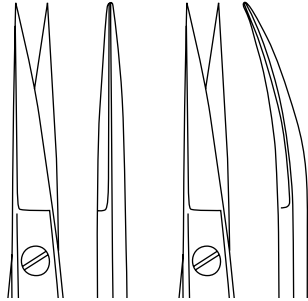

CH-400-16
CH-400-18

CH-401-16
CH-401-18

KELLY

CH-400-16 - CH-401-16 16,0 cm, 6 ¼"
CH-400-18 - CH-401-18 18,0 cm, 7"

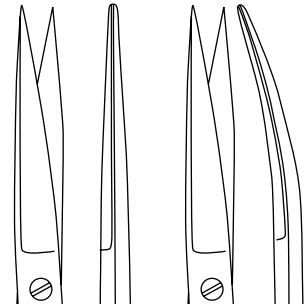

CH-404-14
CH-404-17

CH-405-14
CH-405-17

JOSEPH

CH-404-14 - CH-405-14 14,0 cm, 5 ½"
CH-404-17 - CH-405-17 17,0 cm, 6 ¾"

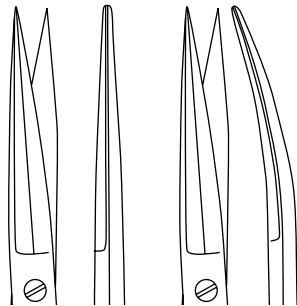

CH-404-15

CH-405-15

PECK-JOSEPH

CH-404-15 - CH-405-15 14,5 cm, 5 ¾"



CHADWICK

CH-407-11 11,0 cm, 4 ¾"

Tonsil Scissors, Cartilage Scissors

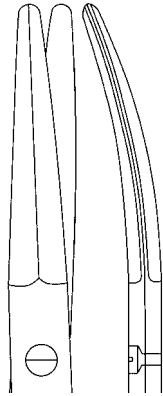
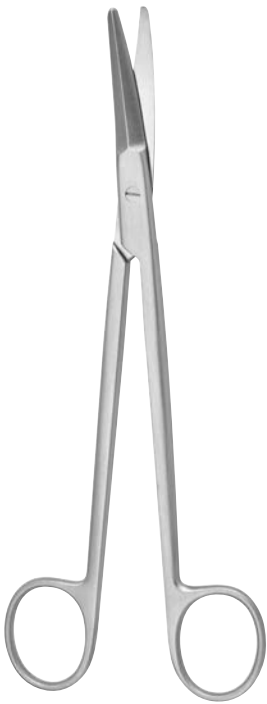

Tonsil scissors

BOETTCHER

CH-301-18 18,0 cm, 7"

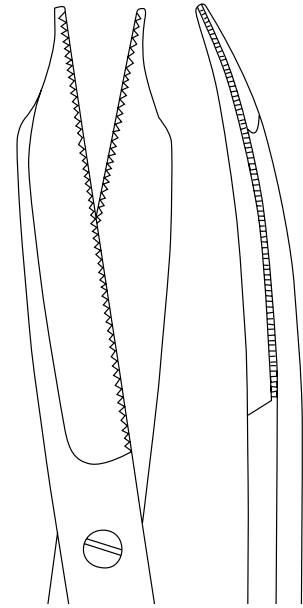
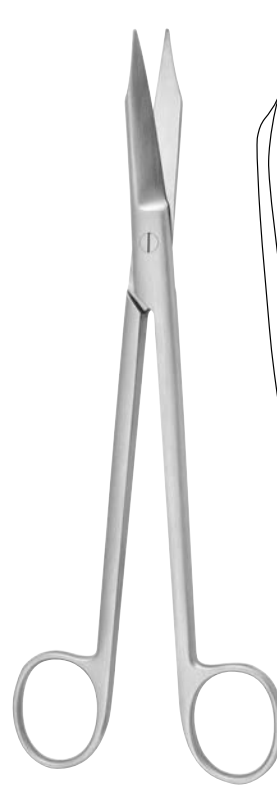

2 blades serrated

MARTIN

CH-301-20 20,0 cm, 8"

Cartilage scissors

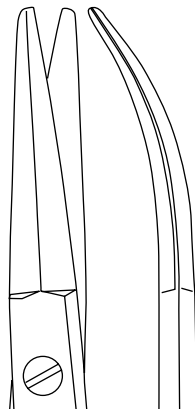

Tonsil scissors

PRINCE

CH-303-17 17,0 cm, 6 3/4"

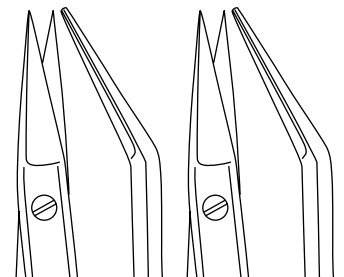

CH-305-17

CH-307-17

1 blade serrated

Tonsil scissors

DEAN

CH-305-17 - CH-307-17 17,0 cm, 6 3/4"

Tonsil Scissors

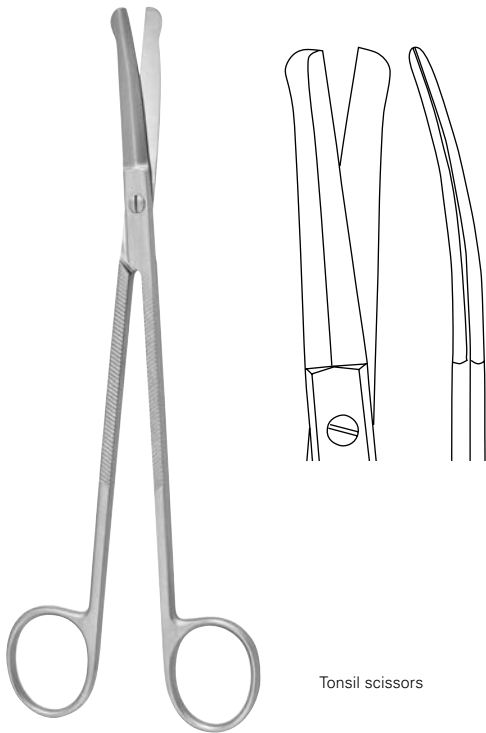

Tonsil scissors

GOOD

CH-309-19 19,0 cm, 7 ½"

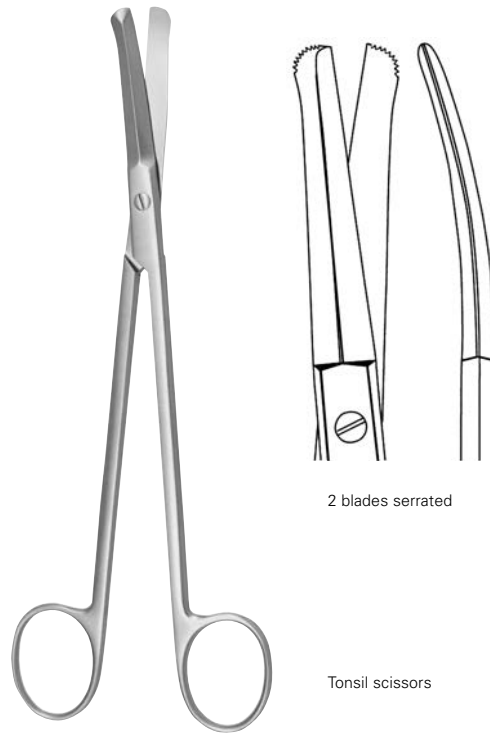

2 blades serrated

Tonsil scissors

GOOD-SCHWEKENDIECK

CH-311-19 19,0 cm, 7 ½"

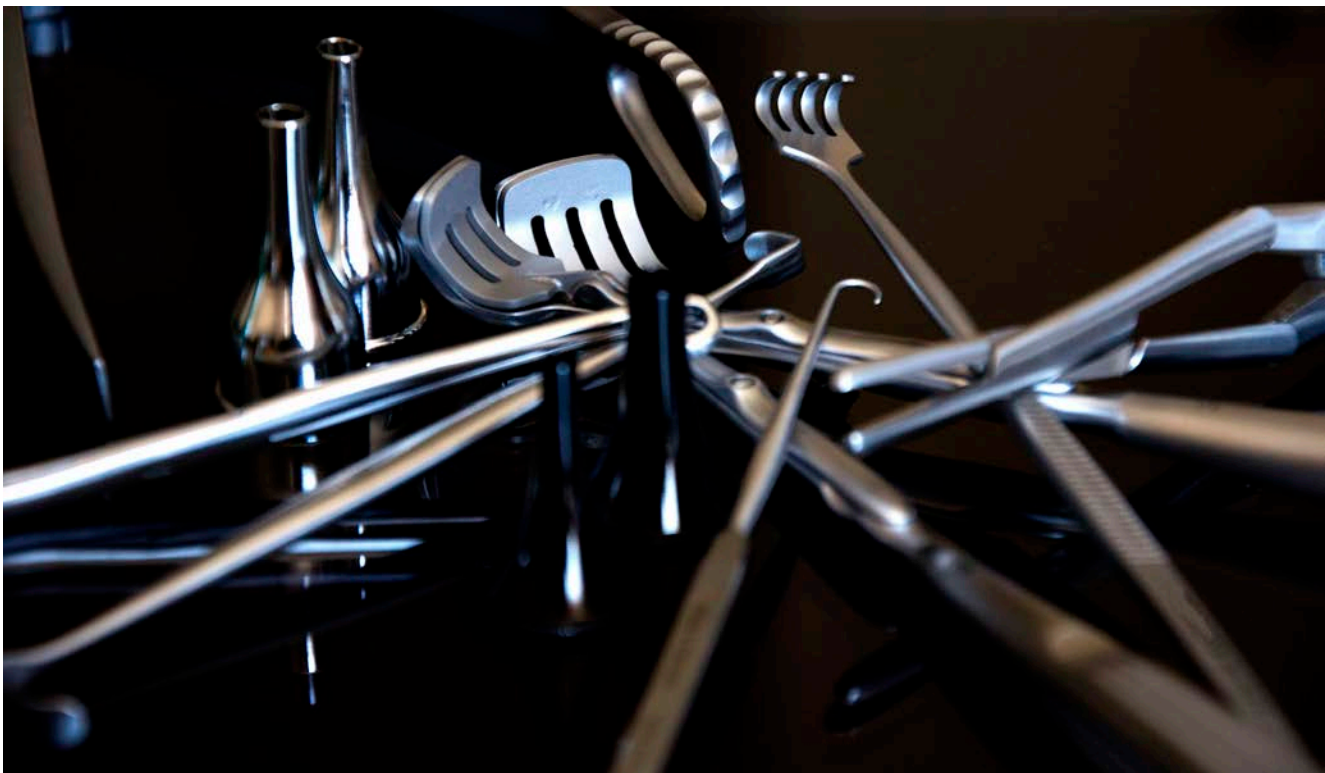

Dissecting Forceps



CH-036-10

Suture forceps

MOORFIELD

CH-036-10 10,0 cm, 4"



CH-038-11

Suture forceps, narrow

BONACCOLTO

CH-038-11 10,0 cm, 4"



CH-036-11

Suture forceps

BONACCOLTO

CH-036-11 10,0 cm, 4"

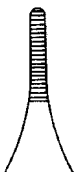

CH-040-12

EWALD

CH-040-12 12,0 cm, 4 3/4"

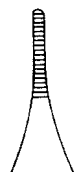

CH-042-12
CH-042-15
CH-042-18

ADSON

CH-042-12 12,0 cm, 4 3/4"
CH-042-15 15,0 cm, 6"
CH-042-18 18,0 cm, 7"



CH-042-12 T

ADSON

CH-042-12 T 12,0 cm, 4 3/4"

Dissecting Forceps



CH-044-12
CH-044-15

ADSON-MICRO

CH-044-12 12,0 cm, 4 $\frac{3}{4}$ "
CH-044-15 15,0 cm, 6 "



CH-046-12

ADSON

CH-046-12 12,0 cm, 4 $\frac{3}{4}$ "



CH-050-15

MC INDOE

CH-050-15 15,0 cm, 6 "



CH-050-15 T

MC INDOE

CH-050-15 T 15,0 cm, 6 "



CH-052-15

GILLIES

CH-052-15 15,0 cm, 6 "



CH-054-12 T

SEMKEN

CH-054-12 T 12,0 cm, 4 $\frac{3}{4}$ "

Dissecting Forceps



CH-054-12
CH-054-15



CH-055-12
CH-055-15

SEMKEN

CH-054-12 - CH-055-12 12,0 cm, 4 ³/₄ "
CH-054-15 - CH-055-15 12,0 cm, 6 "

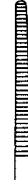

CH-056-17



CH-057-17

TAYLOR

CH-056-17 - CH-057-17 17,0 cm, 6 ³/₄ "



CH-056-17 T



CH-057-17 T

TAYLOR

CH-056-17 T - CH-057-17 T 17,0 cm, 6 ³/₄ "

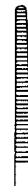

CH-058-17

Dissector end

TAYLOR

CH-058-17 17,0 cm, 6 ³/₄ "

Dissecting Forceps

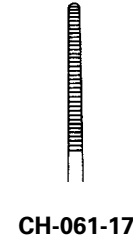
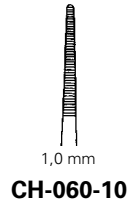
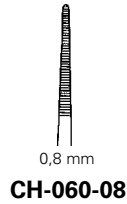
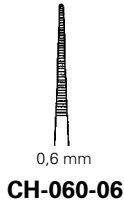

Dissector end

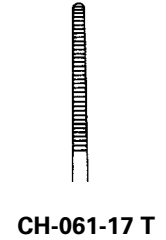

Dissector end

TAYLOR

CH-061-17 17,0 cm, 6 3/4"

TAYLOR

CH-061-17 T 17,0 cm, 6 3/4"

CH-060-06 - CH-060-10 15,5 cm, 6 1/8"

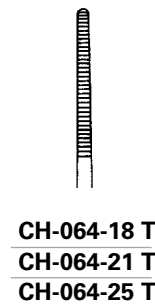

POTTS-SMITH

CH-064-18 - CH-065-18 18,0 cm, 7"
CH-064-21 - CH-065-21 21,0 cm, 8 1/4"
CH-064-25 - CH-065-25 25,0 cm, 9 3/4"
CH-064-30 - CH-065-30 30,0 cm, 11 3/4"

POTTS-SMITH

CH-064-18 T 18,0 cm, 7"
CH-064-21 T 21,0 cm, 8 1/4"
CH-064-25 T 25,0 cm, 9 3/4"

Dissecting Forceps



Dissector end



CH-066-17



CH-067-17

CUSHING

CH-066-17 - CH-067-17 17,0 cm, 6 3/4 "



CH-068-20

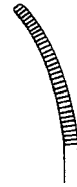

CH-069-20

BROPHY

CH-068-20 - CH-069-20 20,0 cm, 8 "



CH-070-18
CH-070-23

GERALD

CH-070-18 18,0 cm, 7 "
CH-070-23 23,0 cm, 9 "



CH-070-18 T

GERALD

CH-070-18 T 18,0 cm, 7 "



CH-071-18

GERALD

CH-071-18 18,0 cm, 7 "

Tissue Forceps



1 x 2



- CH-106-18**
- CH-106-20**
- CH-106-25**
- CH-106-30**

WAUGH

- CH-106-18** 18,0 cm, 7"
- CH-106-20** 20,0 cm, 8"
- CH-106-25** 25,0 cm, 9 3/4"
- CH-106-30** 30,0 cm, 11 3/4"

1 x 2



- CH-141-12**
- CH-141-15**

ADSON

- CH-141-12** 12,0 cm, 4 3/4"
- CH-141-15** 15,0 cm, 6"

1 x 2



- CH-142-12**
- CH-142-15**
- CH-142-18**

ADSON

- CH-142-12** 12,0 cm, 4 3/4"
- CH-142-15** 15,0 cm, 6"
- CH-142-18** 18,0 cm, 7"

1 x 2



- CH-142-12 T**

ADSON

- CH-142-12 T** 12,0 cm, 4 3/4"

Tissue Forceps



2 x 3

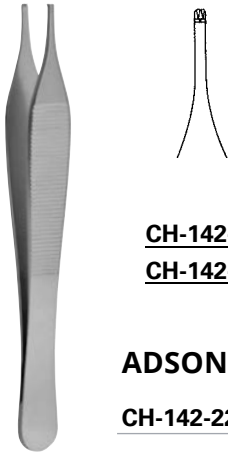

CH-142-22
CH-142-25

ADSON-MICRO

CH-142-22 12,0 cm, 4 3/4"

1 x 2



CH-143-12

ADSON-MICRO

CH-143-12 12,0 cm, 4 3/4"

1 x 2

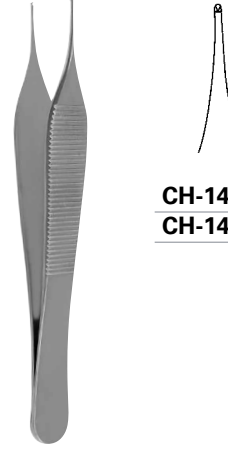

CH-144-12
CH-144-15

ADSON-MICRO

CH-144-12 12,0 cm, 4 3/4"
CH-144-15 15,0 cm, 6"

ADSON

CH-142-22 12,0 cm, 4 3/4"
CH-142-25 15,0 cm, 6"

1 x 2



CH-145-12

ADSON

CH-145-12 12,0 cm, 4 3/4"

1 x 2



CH-146-12

ADSON-MINI

CH-146-12 12,0 cm, 4 3/4"

1 x 2



CH-147-12

ADSON-MICRO

CH-147-12 12,0 cm, 4 3/4"

Tissue Forceps



1 x 2



CH-148-12

ADSON-MICRO

CH-148-12 12,0 cm, 4 3/4"

1 x 2



CH-149-12

ADSON-BIEMER-MICRO

CH-149-12 12,0 cm, 4 3/4"

1 x 2



CH-150-15

MC INDOE

CH-150-15 15,0 cm, 6"

1 x 2



CH-152-15

GILLIES

CH-152-15 15,0 cm, 6"

1 x 2



CH-152-15 T

GILLIES

CH-152-15 T 15,0 cm, 6"

1 x 2



CH-152-16

GILLIES

CH-152-16 15,5 cm, 6 1/8"

Tissue Forceps



1 x 2



13-153-15
13-153-20

MOD. STRASSBURG

CH-153-15 15,0 cm, 6"
CH-153-20 20,0 cm, 8"



1 x 2



13-154-12

2 x 3



13-154-13

1 x 2



13-155-12

SEMKEN

CH-154-12 - 13-155-12 12,5 cm, 5"



1 x 2



CH-154-15

1 x 2



13-155-15

SEMKEN

CH-154-15 - CH-155-15 15,0 cm, 6"



1 x 2



CH-156-17

1 x 2



CH-157-17

TAYLOR

CH-156-17 - CH-157-17 17,0 cm, 6 3/4"



1 x 2



CH-158-17

Dissector end

TAYLOR

CH-158-17 17,0 cm, 6 3/4"

Tissue Forceps



CH-160-06 - CH-160-10 15,0 cm, 6"

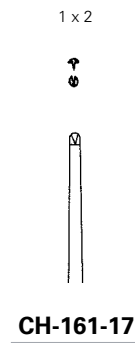

dissector end

TAYLOR

CH-161-17 17,0 cm, 6 3/4"

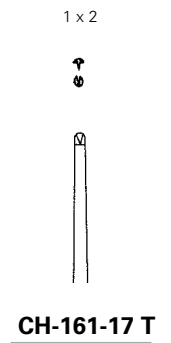

dissector end

TAYLOR

CH-161-17 T 17,0 cm, 6 3/4"

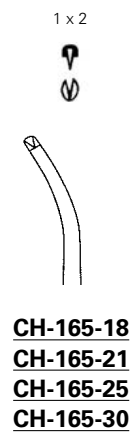
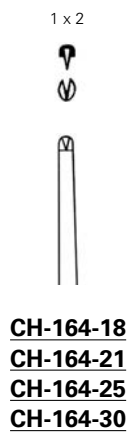

POTTS-SMITH

CH-164-18 - CH-165-18 18,0 cm, 7"
CH-164-21 - CH-165-21 21,0 cm, 8 1/4"
CH-164-25 - CH-165-25 25,0 cm, 9 3/4"
CH-164-30 - CH-165-30 30,0 cm, 11 3/4"

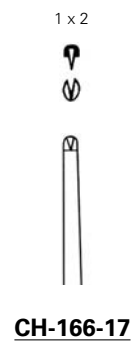

CUSHING

CH-166-17 - CH-167-17 17,0 cm, 6 3/4"

Tissue Forceps



1 x 2



CH-168-20

1 x 2



CH-169-20

BROPHY

CH-168-20 - CH-169-20 20,0 cm, 8"



1 x 2



CH-170-18
CH-170-23

GERALD

CH-170-18 18,0 cm, 7"

CH-170-23 23,0 cm, 9"



1 x 2



CH-170-18 T

GERALD

CH-170-18 T 18,0 cm, 7"



1 x 2



CH-171-18

GERALD

CH-171-18 18,0 cm, 7"



4 x 5

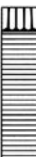

CH-172-15
CH-172-20
CH-172-25

Vascular and tumor forceps

ADLERKREUTZ

CH-172-15 15,0 cm, 6

CH-172-20 20,0 cm, 9"

CH-172-25 25,0 cm, 9 3/4"



2 x 3



CH-173-15
CH-173-20
CH-173-25

Vascular and tumor forceps

ADLERKREUTZ

CH-173-15 15,0 cm, 6

CH-173-20 20,0 cm, 9"

CH-173-25 25,0 cm, 9 3/4"

Non-Traumatic Tissue Forceps



DE BAKEY

Total length



| | | | | | |
|------------------|------------------|------------------|------------------|------------------|------------------|
| 16,5 cm, 6 1/2" | CH-212-16 | CH-210-16 | CH-211-16 | CH-208-16 | CH-209-16 |
| 20,0 cm, 8" | CH-212-20 | CH-210-20 | CH-211-20 | CH-208-20 | CH-209-20 |
| 24,0 cm, 9 1/2" | CH-212-24 | CH-210-24 | CH-211-24 | CH-208-24 | CH-209-24 |
| 30,0 cm, 11 3/4" | | CH-210-30 | CH-211-30 | CH-208-30 | CH-209-30 |



DE BAKEY

Total length



| | | | | | |
|------------------|------------------|------------------|------------------|------------------|-----------------------------------|
| 16,5 cm, 6 1/2" | CH-206-16 | CH-204-16 | CH-200-16 | CH-202-16 | COOLEY CH-230-16 |
| 20,0 cm, 8" | CH-206-20 | CH-204-20 | CH-200-20 | CH-202-20 | CH-230-20 |
| 24,0 cm, 9 1/2" | CH-206-24 | CH-204-24 | CH-200-24 | CH-202-24 | CH-230-24 |
| 30,0 cm, 11 3/4" | CH-206-30 | CH-204-30 | CH-200-30 | CH-202-30 | |

Non-Traumatic Tissue Forceps



DE BAKEY

Total length



| | | | | | |
|-----------------|------------------|------------------|------------------|------------------|------------------|
| 15,0 cm, 6 " | CH-240-15 | CH-242-15 | CH-244-15 | CH-246-15 | CH-247-15 |
| 20,0 cm, 8 " | CH-240-20 | CH-242-20 | CH-244-20 | CH-246-20 | CH-247-20 |
| 24,0 cm, 9 ½ " | CH-240-24 | CH-242-24 | CH-244-24 | CH-246-24 | CH-247-24 |
| 30,0 cm, 11 ¾ " | | | | CH-246-30 | CH-247-30 |



DE BAKEY

Total length



| | | | | | |
|-----------------|------------------|------------------|------------------|------------------|--------------------|
| 16,5 cm, 6 ½ " | CH-248-15 | | CH-250-15 | CH-252-15 | CH-232-16 T |
| 20,0 cm, 8 " | CH-248-20 | CH-249-20 | CH-250-20 | CH-252-20 | CH-230-20 T |
| 24,0 cm, 9 ½ " | CH-248-24 | | CH-250-24 | CH-252-24 | CH-230-24 T |
| 30,0 cm, 11 ¾ " | CH-248-30 | | CH-250-30 | CH-252-30 | |

COOLEY

Haemostatic Forceps



CH-030-18

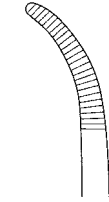

CH-031-19



CH-033-14



ADSON

CH-030-18 18,5 cm, 7 ¼"
CH-031-19 19,0 cm, 7 ½"

MICRO-ADSON

CH-033-14 14,0 cm, 5 ½"



CH-034-16



CH-034-20



CH-035-16



CH-035-20



ROCHESTER-CARMALT

CH-034-16 - CH-035-16 16,0 cm, 6 ¼"
CH-034-20 - CH-035-20 20,0 cm, 8"

Haemostatic Forceps

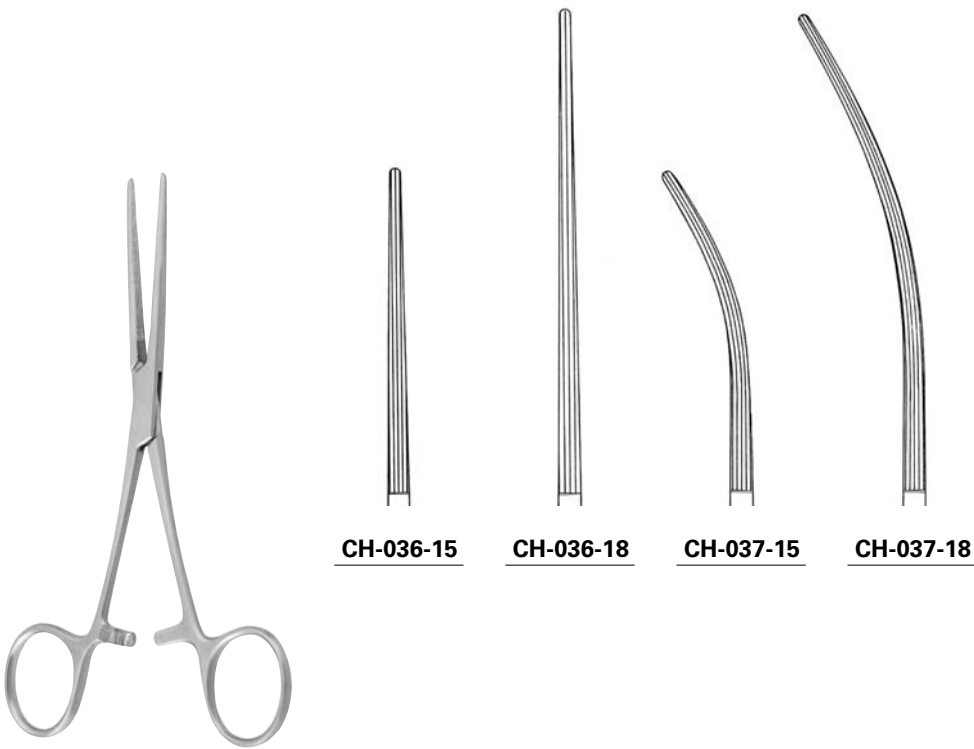

CH-036-15

CH-036-18

CH-037-15

CH-037-18

BAINBRIDGE

CH-036-15 - 15-037-15 15,0 cm, 6"

CH-036-18 - 15-037-18 18,0 cm, 7"

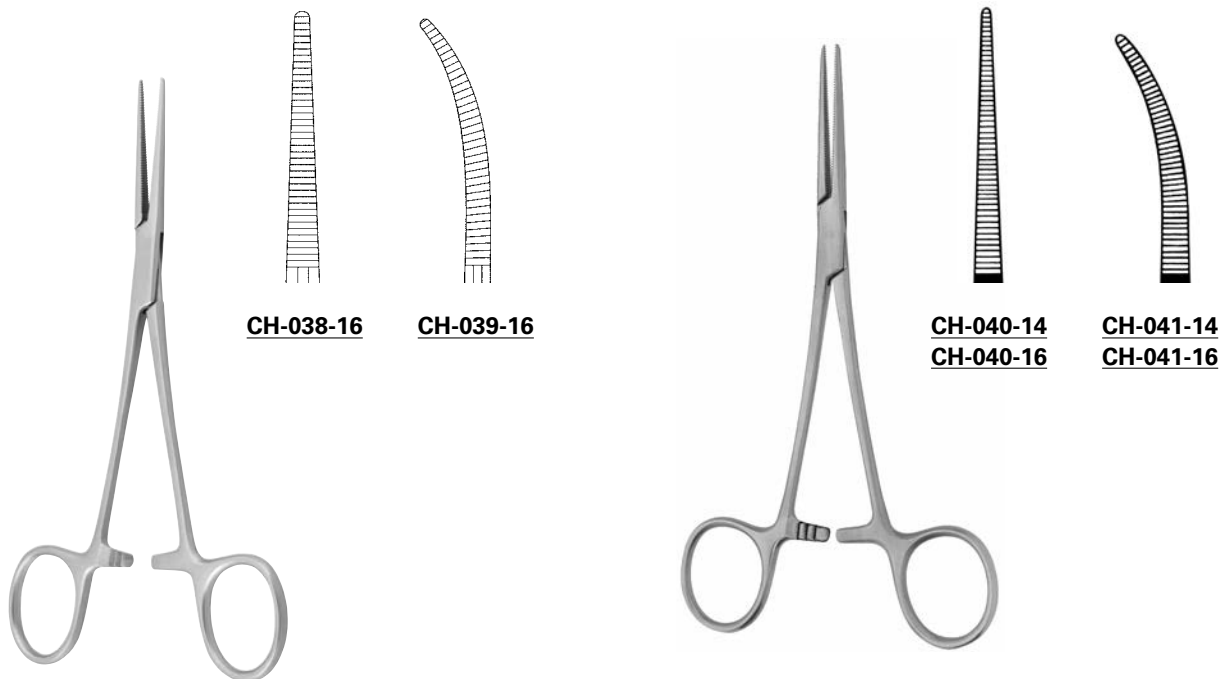

CH-038-16

CH-039-16

CH-040-14
CH-040-16

CH-041-14
CH-041-16

CRILE-RANKIN

CH-038-16 - CH-039-16 16,0 cm, 6 ¼"

CH-040-16 - CH-041-16 16,0 cm, 6 ¼"

Haemostatic Forceps

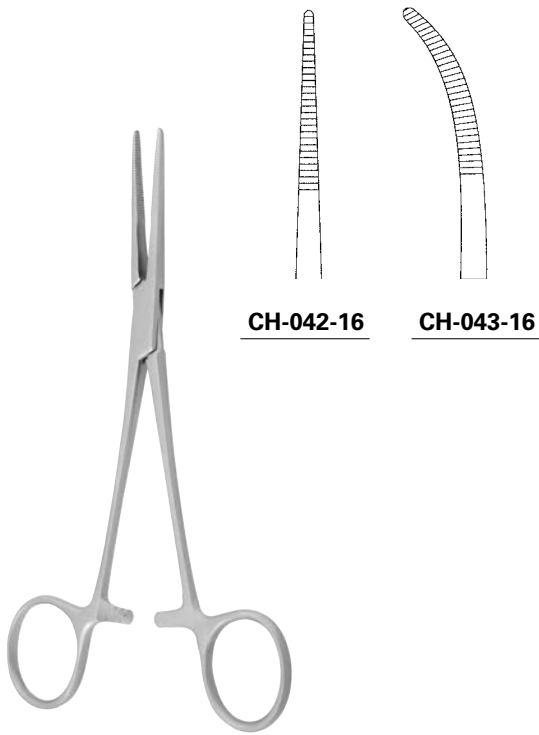

CH-042-16

CH-043-16

KELLY-RANKIN

CH-042-16 - CH-043-16 16,0 cm, 6 ¼"

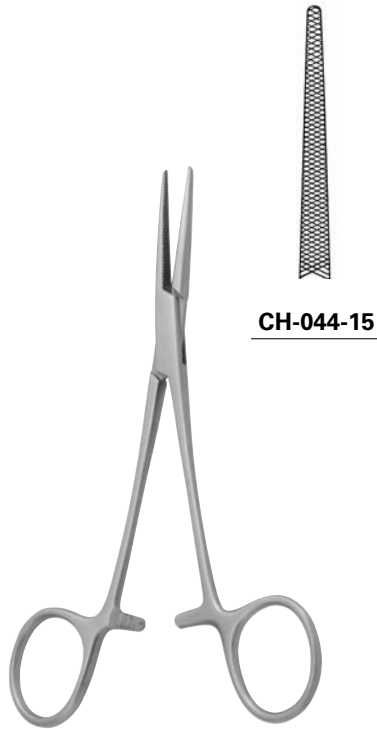

CH-044-15

DIXON-LOVELACE

CH-044-15 15,0 cm, 6"

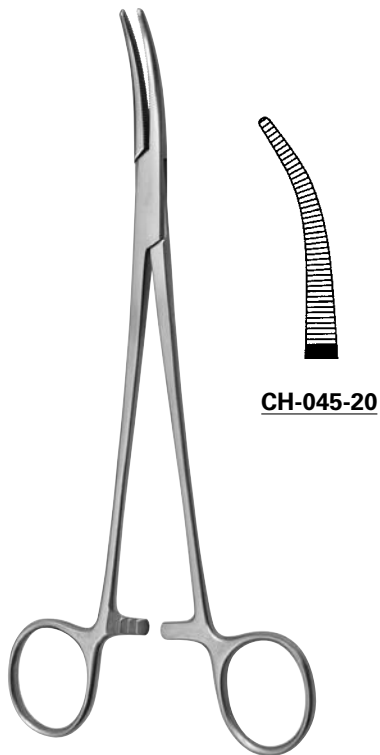

CH-045-20

FUCHSIG

CH-045-20 20,0 cm, 8"

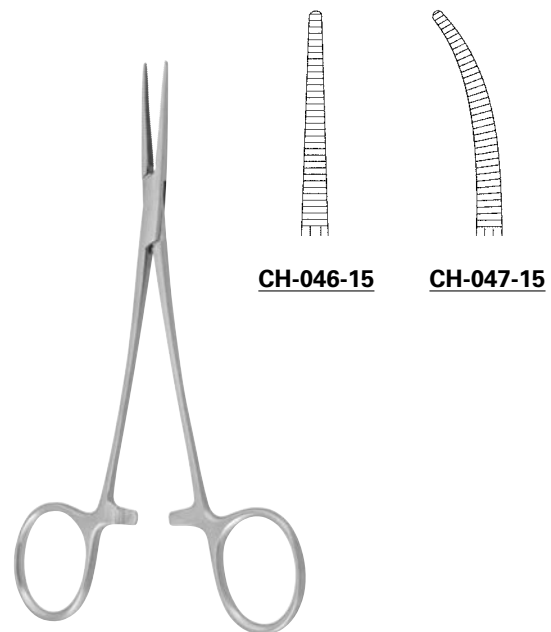

CH-046-15

CH-047-15

LERICHE

CH-046-15 - CH-047-15 15,0 cm, 6"

Haemostatic Forceps

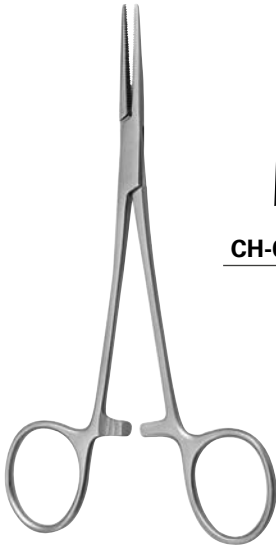

CH-048-13



CH-049-13

BABY-CRILE

CH-048-13 - CH-049-13 14,0 cm, 5 ½ "



CH-048-14

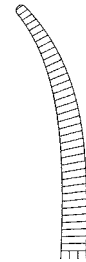

CH-049-14

CRILE

CH-048-14 - CH-049-14 14,0 cm, 5 ½ "

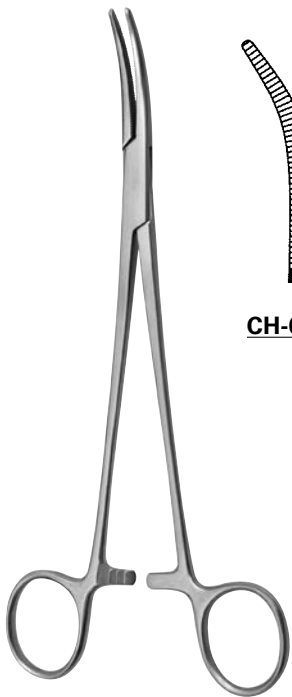

CH-049-18

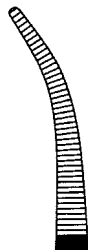

CRILE (FRASER-KELLY)

CH-049-18 18,0 cm, 7 "



CH-050-10



CH-050-10 10,0 cm, 4 "



CH-051-12



MOSQUITO-DANDY

CH-051-12 12,0 cm, 4 ¾ "

Haemostatic Forceps

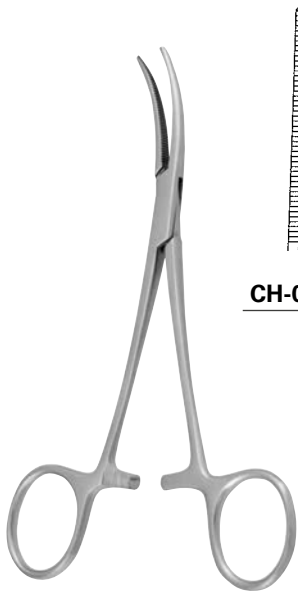

CH-051-14

DANDY

CH-051-14 14,0 cm, 5 ½"

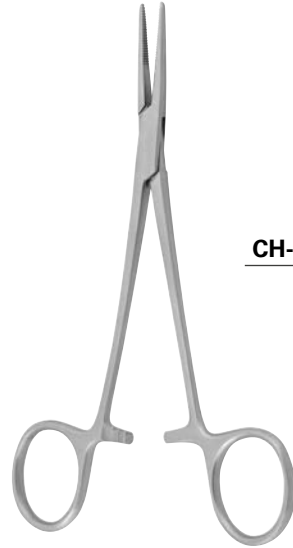

CH-052-14

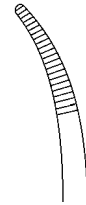

CH-053-14

KELLY

CH-052-14 - 1 CH-053-14 14,0 cm, 5 ½"



CH-054-14

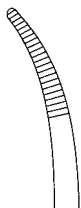

CH-055-14

PROVIDENCE-HOSPITAL

CH-054-14 - CH-055-14 14,0 cm, 5 ½"

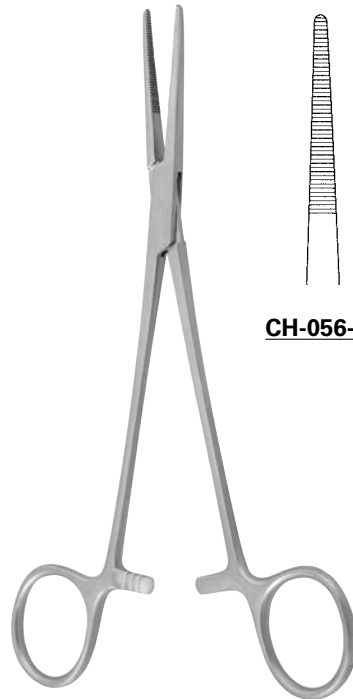

CH-056-18

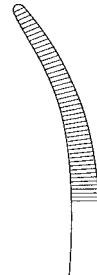

CH-057-18

BIRKETT

CH-056-18 - CH-057-18 18,5 cm, 7 ¼"

Haemostatic Forceps



CH-060-12



CH-060-14



CH-061-12



CH-061-14

HALSTED-MOSQUITO

CH-060-12 - CH-061-12 12,5 cm, 5"
CH-060-14 - CH-061-14 14,0 cm, 5 1/2"

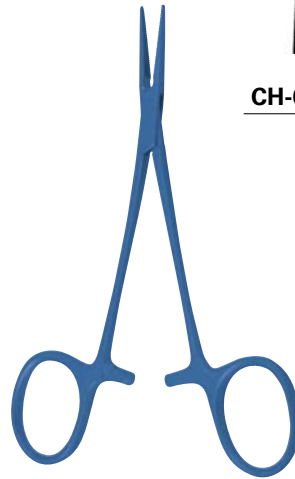

CH-060-12 T



CH-061-12 T

HALSTED-MOSQUITO

CH-060-12 T - CH-061-12 T 12,5 cm, 5"



CH-062-10



CH-062-12



CH-063-10



CH-063-12

MICRO-MOSQUITO

CH-062-10 - CH-063-10 10,0 cm, 4"
CH-062-12 - CH-063-12 12,5 cm, 5"



CH-064-10

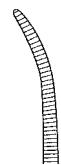

CH-065-10



HARTMANN

CH-064-10 - CH-065-10 10,0 cm, 4"

Haemostatic Forceps



CH-066-08



CH-067-12



CARREL

CH-066-08 8,0 cm, 3 1/8"



BABY-MOSQUITO

CH-067-12 12,0 cm, 4 3/4"



CH-068-14

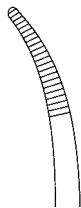

CH-069-14

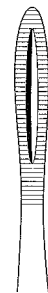

CH-072-13



CAIRNS

CH-068-14 - CH-069-14 14,0 cm, 5 1/2"



KROENLEIN

CH-072-13 13,0 cm, 5 1/8"

Haemostatic Forceps



CH-010-13



CH-010-14



CH-010-16



CH-010-18

Delicate

PEAN

| | |
|------------------|-----------------|
| CH-010-13 | 13,0 cm, 5 1/8" |
| CH-010-14 | 14,0 cm, 5 1/2" |
| CH-010-16 | 16,0 cm, 6 1/4" |
| CH-010-18 | 18,0 cm, 7" |



CH-011-13



CH-011-14



CH-011-16



CH-011-18

Delicate

PEAN

| | |
|------------------|-----------------|
| CH-011-13 | 13,0 cm, 5 1/8" |
| CH-011-14 | 14,0 cm, 5 1/2" |
| CH-011-16 | 16,0 cm, 6 1/4" |
| CH-011-18 | 18,0 cm, 7" |

Haemostatic Forceps

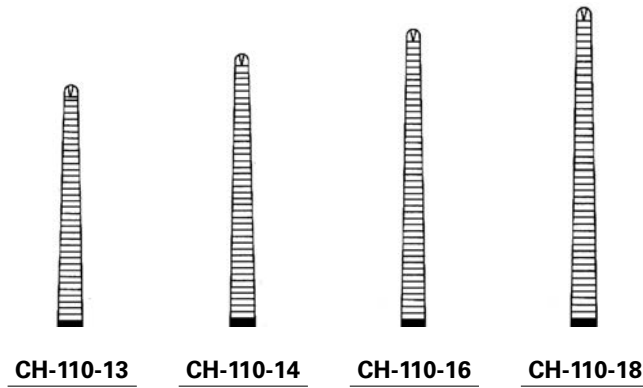

Delicate

KOCHER

CH-110-13 13,0 cm, 5 1/8"

CH-110-14 14,0 cm, 5 1/2"

CH-110-16 16,0 cm, 6 1/4"

CH-110-18 18,0 cm, 7"

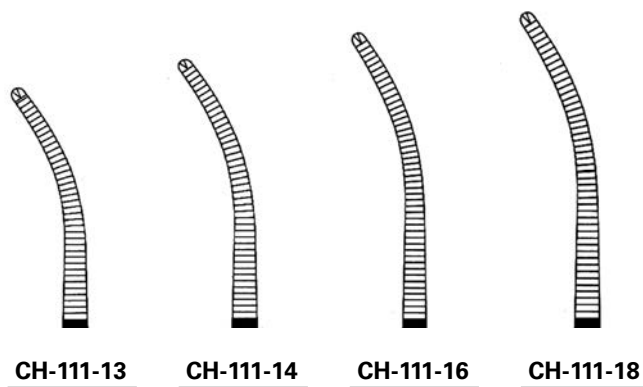

Delicate

KOCHER

CH-111-13 13,0 cm, 5 1/8"

CH-111-14 14,0 cm, 5 1/2"

CH-111-16 16,0 cm, 6 1/4"

CH-111-18 18,0 cm, 7"

Haemostatic Forceps

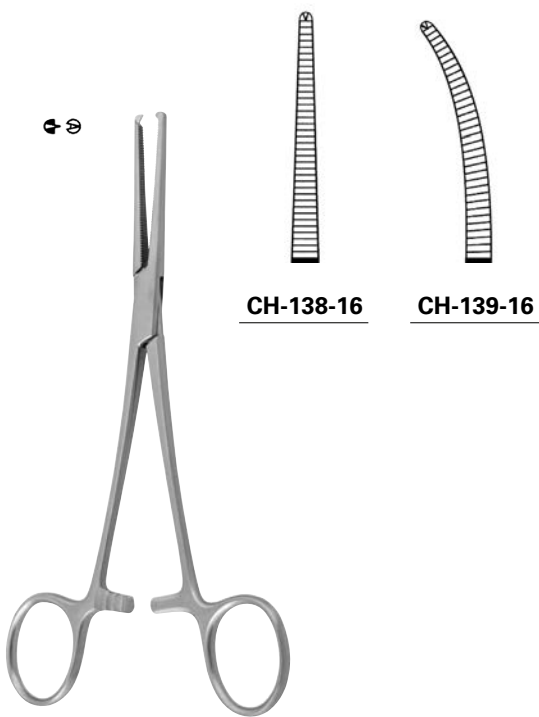

CH-138-16

CH-139-16

CRILE-RANKIN

CH-138-16 - CH-139-16 16,0 cm, 6 ¼"

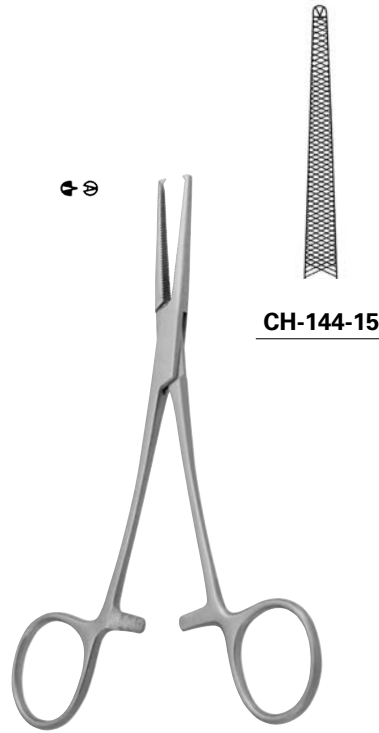

CH-144-15

DIXON-LOVELACE

CH-144-15 15,0 cm, 6"

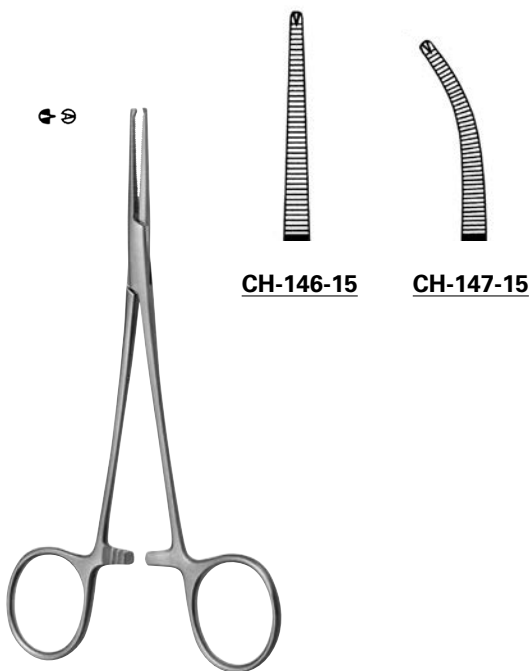

CH-146-15

CH-147-15

LERICHE

CH-146-15 - CH-147-15 15,0 cm, 6"

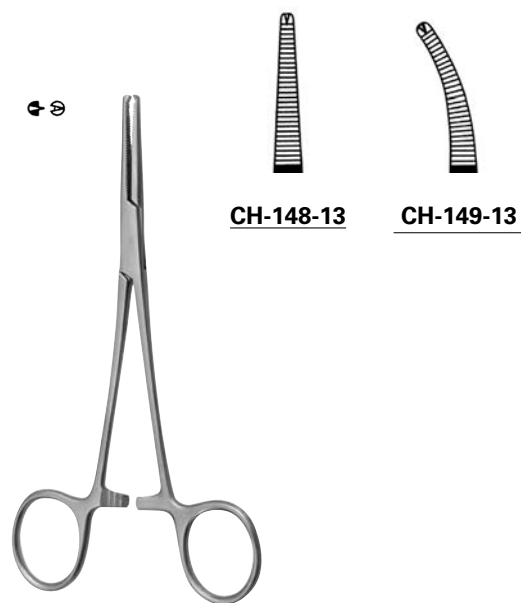

CH-148-13

CH-149-13

BABY-CRILE

CH-148-13 - CH-149-13 14,0 cm, 5 ½"

Haemostatic Forceps

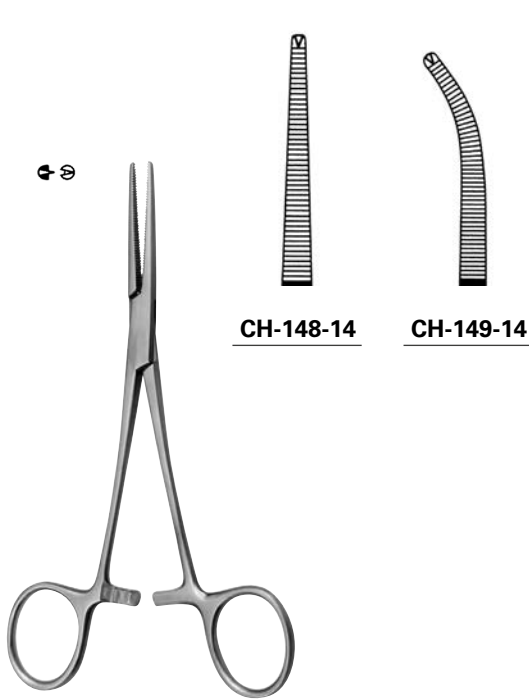

CRILE

CH-148-14 - CH-149-14 14,0 cm, 5 ½"

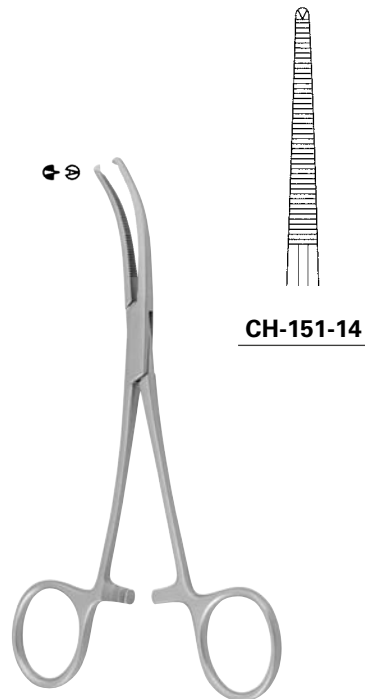

DANDY

CH-151-14 14,0 cm, 5 ½"

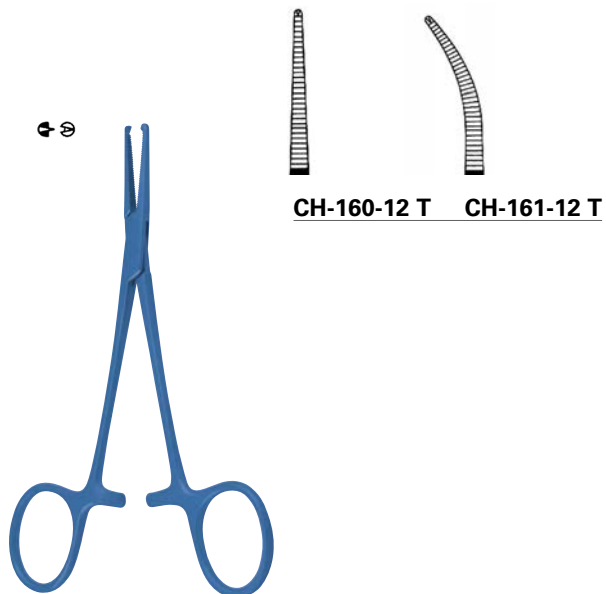

HALSTED-MOSQUITO

CH-160-12 T - CH-161-12 T 12,5 cm, 5"

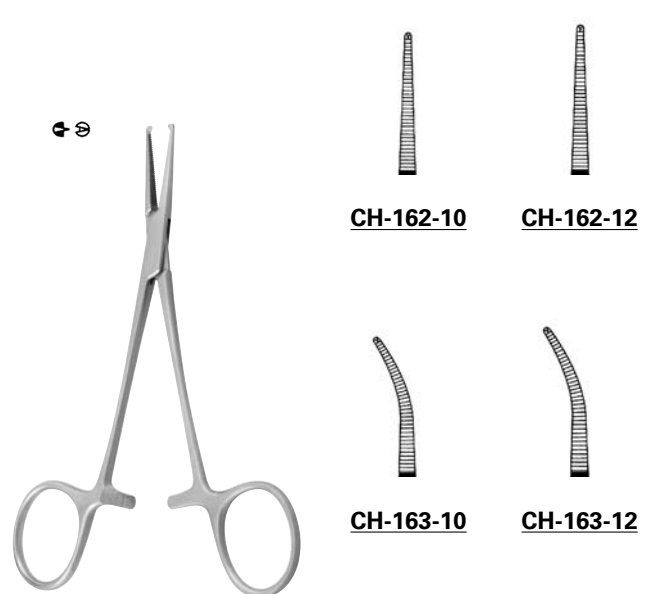

MICRO-MOSQUITO

CH-162-10 - CH-163-10 10,0 cm, 4"
CH-162-12 - CH-163-12 12,5 cm, 5"

Dissecting and Ligature Forceps

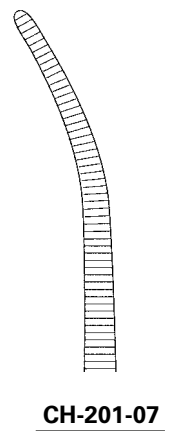
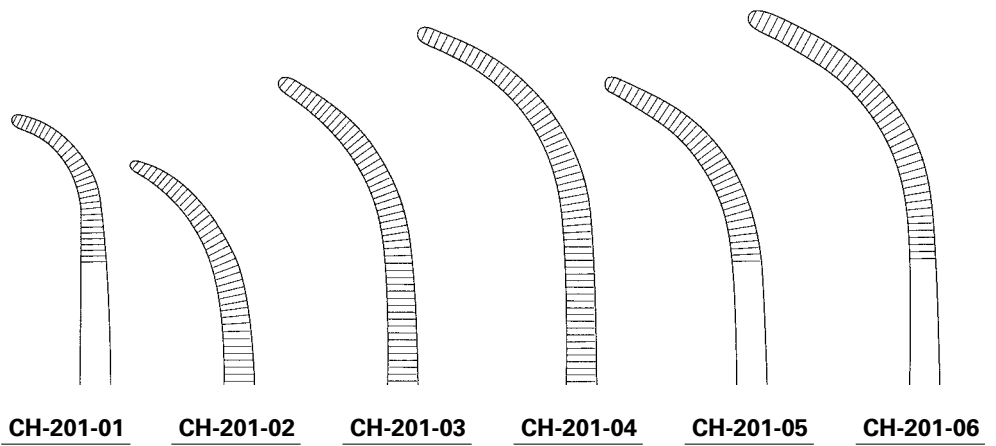

OVERHOLT-GEISSENDOERFER

CH-201-01 - CH-201-07 21,0 cm, 8 ¼"

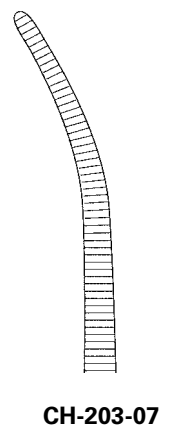
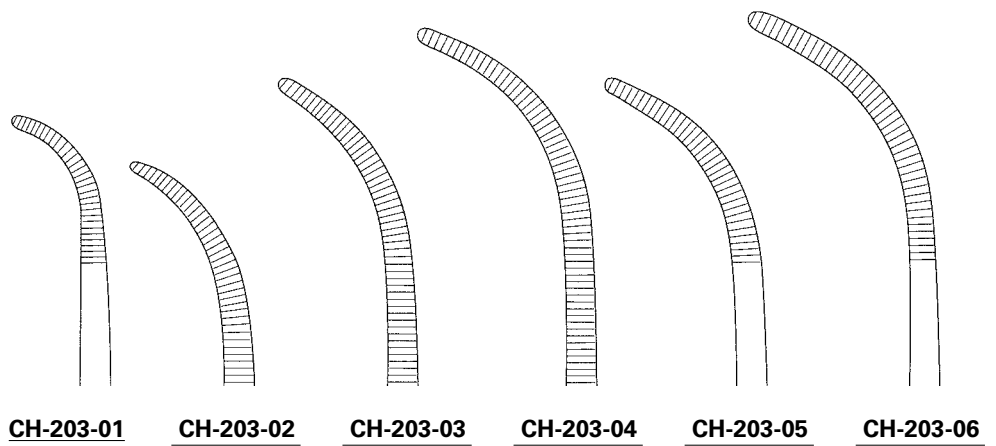

OVERHOLT-GEISSENDOERFER

CH-203-01 - CH-203-07 27,0 cm, 10¾"

Dissecting and Ligature Forceps

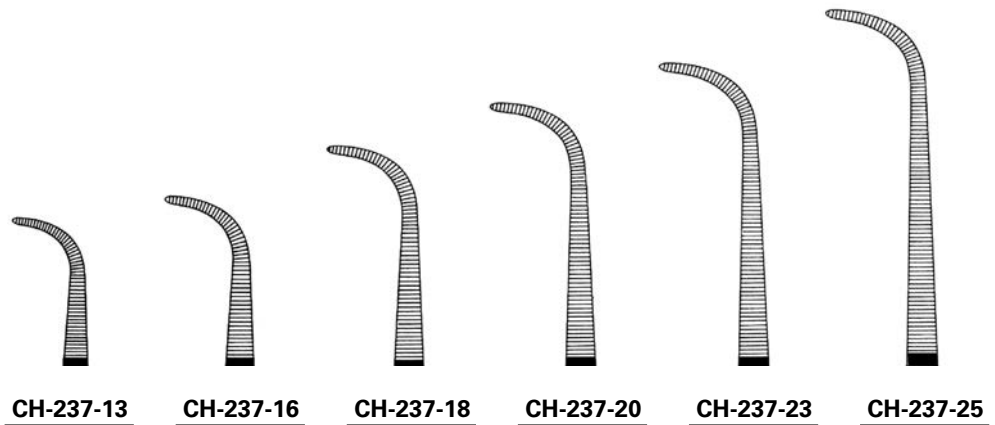

CH-237-13 **CH-237-16** **CH-237-18** **CH-237-20** **CH-237-23** **CH-237-25**

GEMINI

| | |
|------------------|-----------------|
| CH-237-13 | 13,0 cm, 5 1/8" |
| CH-237-16 | 16,0 cm, 6 1/4" |
| CH-237-18 | 18,0 cm, 7" |
| CH-237-20 | 20,0 cm, 8" |
| CH-237-23 | 23,0 cm, 9" |
| CH-237-25 | 25,0 cm, 9 3/4" |
| CH-237-28 | 28,0 cm, 11" |

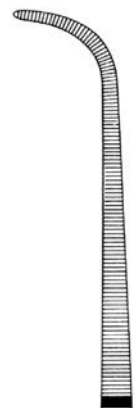

CH-237-28

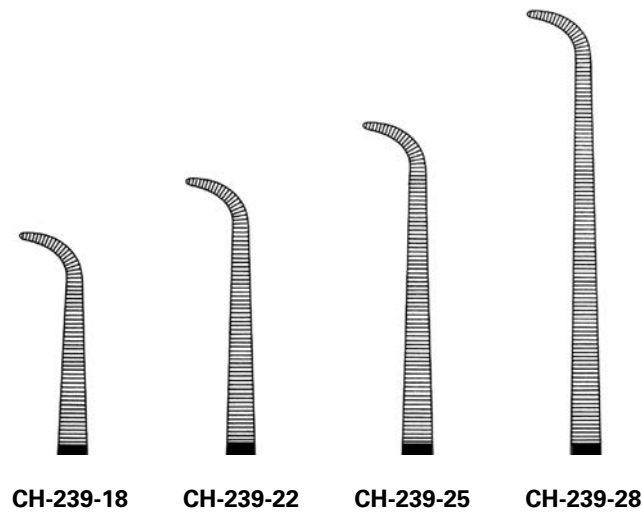

CH-239-18 **CH-239-22** **CH-239-25** **CH-239-28**

GEMINI

| | |
|------------------|-----------------|
| CH-239-18 | 18,0 cm, 7" |
| CH-239-22 | 22,0 cm, 8 3/4" |
| CH-239-25 | 25,0 cm, 9 3/4" |
| CH-239-28 | 28,0 cm, 11" |

Tissue Grasping Forceps



SCHEIBE ATRAUMA

| | |
|------------------|--------------|
| CH-755-18 | 18,0 cm, 7 " |
| CH-755-20 | 20,0 cm, 8 " |
| CH-755-23 | 23,0 cm, 9 " |



CH-755-18

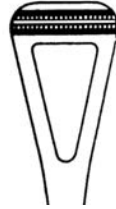

CH-755-20

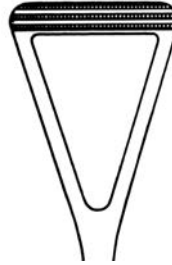

CH-755-23



PENNINGTON

| | |
|------------------|--------------|
| CH-756-15 | 15,0 cm, 6 " |
| CH-756-20 | 20,0 cm, 8 " |



CH-756-15
CH-756-20



LOCKWOOD

| | |
|------------------|--------------|
| CH-758-20 | 20,0 cm, 8 " |
|------------------|--------------|



CH-758-20



BABCOCK

| | |
|------------------|----------------|
| CH-760-16 | 16,0 cm, 6 ¼ " |
| CH-760-18 | 18,0 cm, 7 " |
| CH-760-20 | 20,0 cm, 8 " |
| CH-760-24 | 24,0 cm, 9 ½ " |
| CH-760-36 | 36,0 cm, 14 " |
| CH-760-40 | 40,0 cm, 16 " |



Tissue Grasping Forceps



CH-762-16



CH-762-20



CH-762-22



BABCOCK ATRAUMA

| | |
|------------------|-----------------|
| CH-762-16 | 16,0 cm, 6 1/4" |
| CH-762-20 | 20,5 cm, 8" |
| CH-762-22 | 22,0 cm, 8 3/4" |



CH-764-16



CH-764-20



BABCOCK

| | |
|------------------|-----------------|
| CH-764-16 | 16,0 cm, 6 1/4" |
| CH-764-20 | 20,5 cm, 8" |

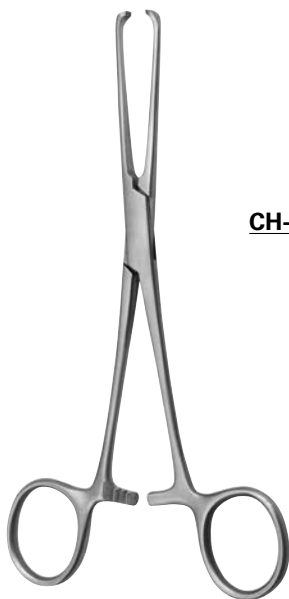

CH-765-02



CH-765-03



ALLIS

| | |
|------------------------------|-----------------|
| CH-765-02 - CH-765-03 | 15,5 cm, 6 1/8" |
|------------------------------|-----------------|



CH-766-12



BABY-ALLIS

| | |
|------------------|-------------|
| CH-766-12 | 12,5 cm, 5" |
|------------------|-------------|



CH-766-14



ALLIS

| | |
|------------------|-------------|
| CH-766-14 | 15,0 cm, 6" |
|------------------|-------------|

Tissue Grasping Forceps



5 x 6



- CH-766-15**
- CH-766-19**
- CH-766-22**
- CH-766-25**



- CH-768-16**
- CH-768-20**
- CH-768-22**
- CH-768-25**
- CH-768-30**

ALLIS

| | |
|------------------|----------------|
| CH-766-15 | 15,0 cm, 6 " |
| CH-766-19 | 19,0 cm, 7 ½ " |
| CH-766-22 | 22,0 cm, 8 ¾ " |
| CH-766-25 | 25,0 cm, 9 ¾ " |

ALLIS ATRAUMA

| | |
|------------------|-----------------|
| CH-768-16 | 16,0 cm, 6 ¼ " |
| CH-768-20 | 20,0 cm, 8 " |
| CH-768-22 | 22,0 cm, 8 ¾ " |
| CH-768-25 | 25,0 cm, 9 ¾ " |
| CH-768-30 | 30,0 cm, 11 ¾ " |



6 x 7



- CH-770-20**



5 x 6



- CH-770-21**
- CH-770-22**

THOMS-ALLIS

| | |
|------------------|--------------|
| CH-770-20 | 20,0 cm, 8 " |
|------------------|--------------|

ALLIS

| | |
|------------------|----------------|
| CH-770-21 | 20,0 cm, 8 " |
| CH-770-22 | 22,0 cm, 8 ¾ " |

Tissue Grasping Forceps

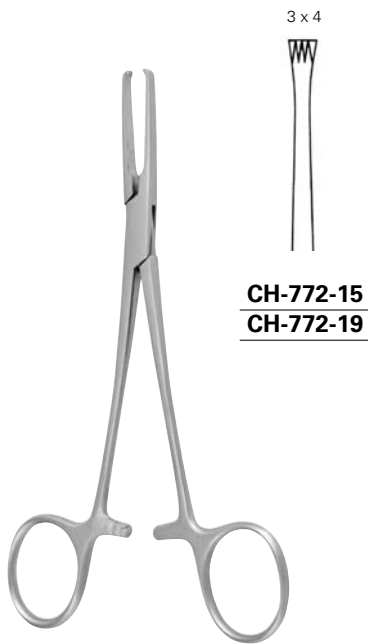

CH-772-15
CH-772-19

JUDD-ALLIS

CH-772-15 15,5 cm, 6 1/8"
CH-772-19 19,0 cm, 7 1/2"

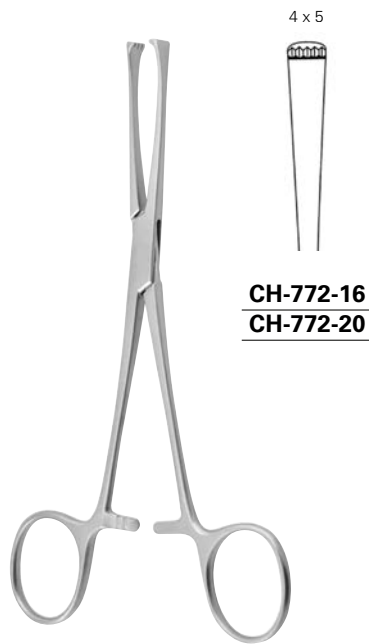

CH-772-16
CH-772-20

LOCKWOOD-ALLIS

CH-772-16 16,0 cm, 6 1/4"
CH-772-20 20,0 cm, 8"



LITTLEWOOD

CH-773-19 19,0 cm, 7 1/2"

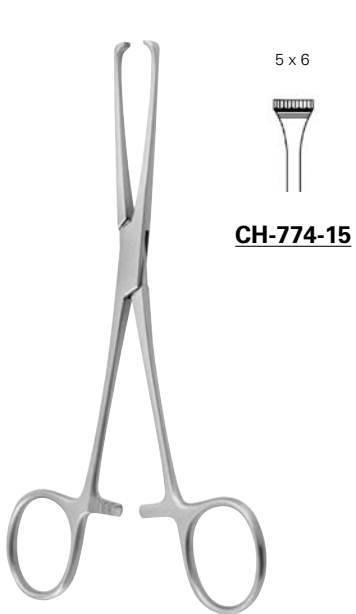

CH-774-15

BOYS-ALLIS

CH-774-15 15,0 cm, 6"

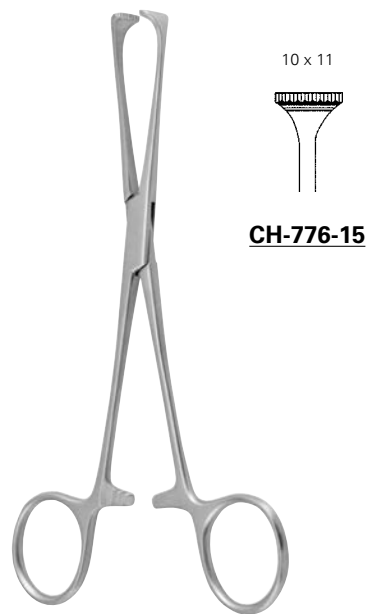

CH-776-15

ALLIS-ADAIR

CH-776-15 16,0 cm, 6 1/4"



CH-778-13

TUFFIER

CH-778-13 13,0 cm, 5 1/8"

Towel Clamps



BACKHAUS-KOCHER

CH-800-13 13,0 cm, 5 1/8"



BACKHAUS

| | |
|------------------|-----------------|
| CH-801-08 | 8,0 cm, 3 1/8" |
| CH-801-11 | 11,0 cm, 4 3/8" |
| CH-801-13 | 13,0 cm, 5 1/8" |
| CH-801-15 | 15,0 cm, 6" |



CH-801-08
CH-801-11
CH-801-13
CH-801-15

Holder for cable up to Ø 5,0

Holder for rubber tube up to Ø 13,0 mm

Holder for rubber tube up to Ø 15,0 mm



ROBIN

CH-802-13 13,0 cm, 5 1/8"



ROBIN

CH-802-14 13,0 cm, 5 1/8"



BACKHAUS

CH-803-11 11,0 cm, 4 3/8"

Towel Clamps

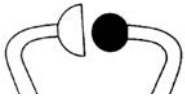

BALL & SOCKET

CH-805-11 11,0 cm, 4 $\frac{3}{8}$ "
CH-805-14 14,0 cm, 5 $\frac{1}{2}$ "



BERNHARD

CH-807-16 16,0 cm, 6 $\frac{1}{4}$ "



ROEDER

CH-809-13 13,0 cm, 5 $\frac{1}{8}$ "
CH-809-15 15,0 cm, 6 "



LANE

CH-811-13 13,0 cm, 5 $\frac{1}{8}$ "
CH-811-15 15,0 cm, 6 "
CH-811-20 20,0 cm, 8 "



DOYEN

CH-813-18 18,0 cm, 7 "



SCHAEDEL

CH-816-09 9,0 cm, 3 $\frac{1}{2}$ "



SCHAEDEL

CH-817-09 9,0 cm, 3 $\frac{1}{2}$ "

Towel Clamps



JONES

- CH-819-05** 5,5 cm, 2 1/8"
- CH-819-09** 9,0 cm, 3 1/2"

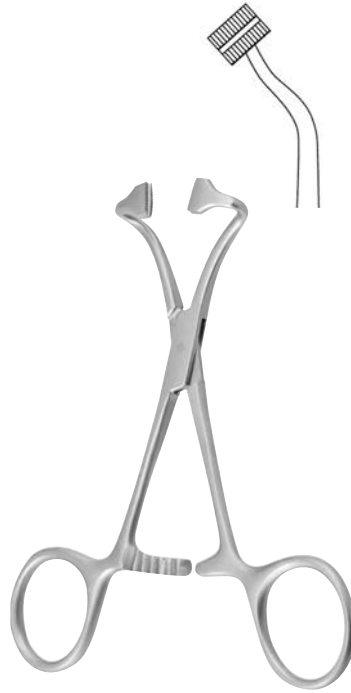

PEERS-BERTRAM

- CH-821-14** 14,5 cm, 5 3/4"



LORNA (EDNA)

- CH-823-10** 9,5 cm, 3 3/4"
- CH-823-13** 13,0 cm, 5 1/8"



TOHOKU

- CH-825-10** 10,0 cm, 4"
- CH-825-13** 13,0 cm, 5 1/8"



HOFF

- CH-829-10** 10,0 cm, 4"
- CH-829-12** 12,0 cm, 4 3/4"
- CH-829-14** 14,0 cm, 5 1/2"

- CH-827-13** 13,0 cm, 5 1/8"

Tubing Clamps

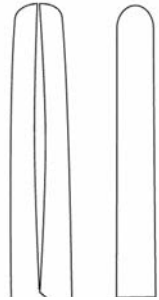

CH-840-16
CH-840-18
CH-840-20
CH-840-24

| | |
|------------------|---------------|
| CH-840-16 | 16,0 cm, 6 ¼" |
| CH-840-18 | 18,0 cm, 7" |
| CH-840-20 | 20,0 cm, 8" |
| CH-840-24 | 24,0 cm, 9 ½" |



CH-842-14
CH-842-16
CH-842-20

BERLIN

| | |
|------------------|---------------|
| CH-842-14 | 14,0 cm, 5 ½" |
| CH-842-16 | 16,5 cm, 6 ½" |
| CH-842-20 | 20,0 cm, 8" |



CH-844-15

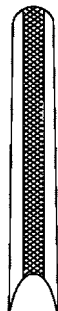

CH-844-18

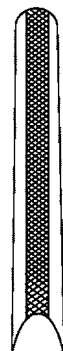

CH-844-20

| | |
|------------------|-------------|
| CH-844-15 | 15,0 cm, 6" |
| CH-844-18 | 18,0 cm, 7" |
| CH-844-20 | 20,0 cm, 8" |

Tubing Clamps

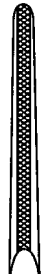

CH-846-15

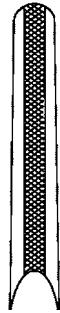

CH-846-18

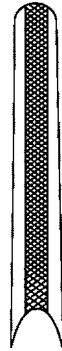

CH-846-20

- CH-846-15** 15,0 cm, 6 "
- CH-846-18** 18,0 cm, 7 "
- CH-846-20** 20,0 cm, 8 "



CH-849-16 16,0 cm, 6 ¼ "

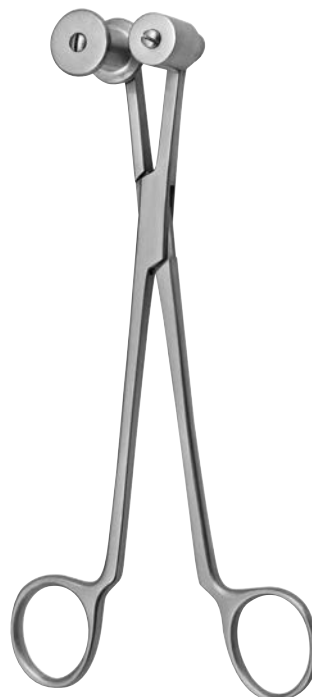

GUNAR-HEY

CH-848-18 18,0 cm, 7 "

Safety Pins



BUNT

CH-851-12 12,0 cm, 4 $\frac{3}{4}$ ''



MAYO

CH-851-13 13,0 cm, 5 $\frac{1}{8}$ ''

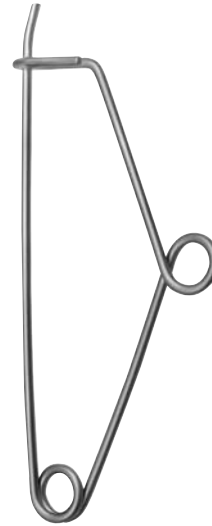

MAYO

CH-851-14 14,0 cm, 5 $\frac{1}{2}$ ''

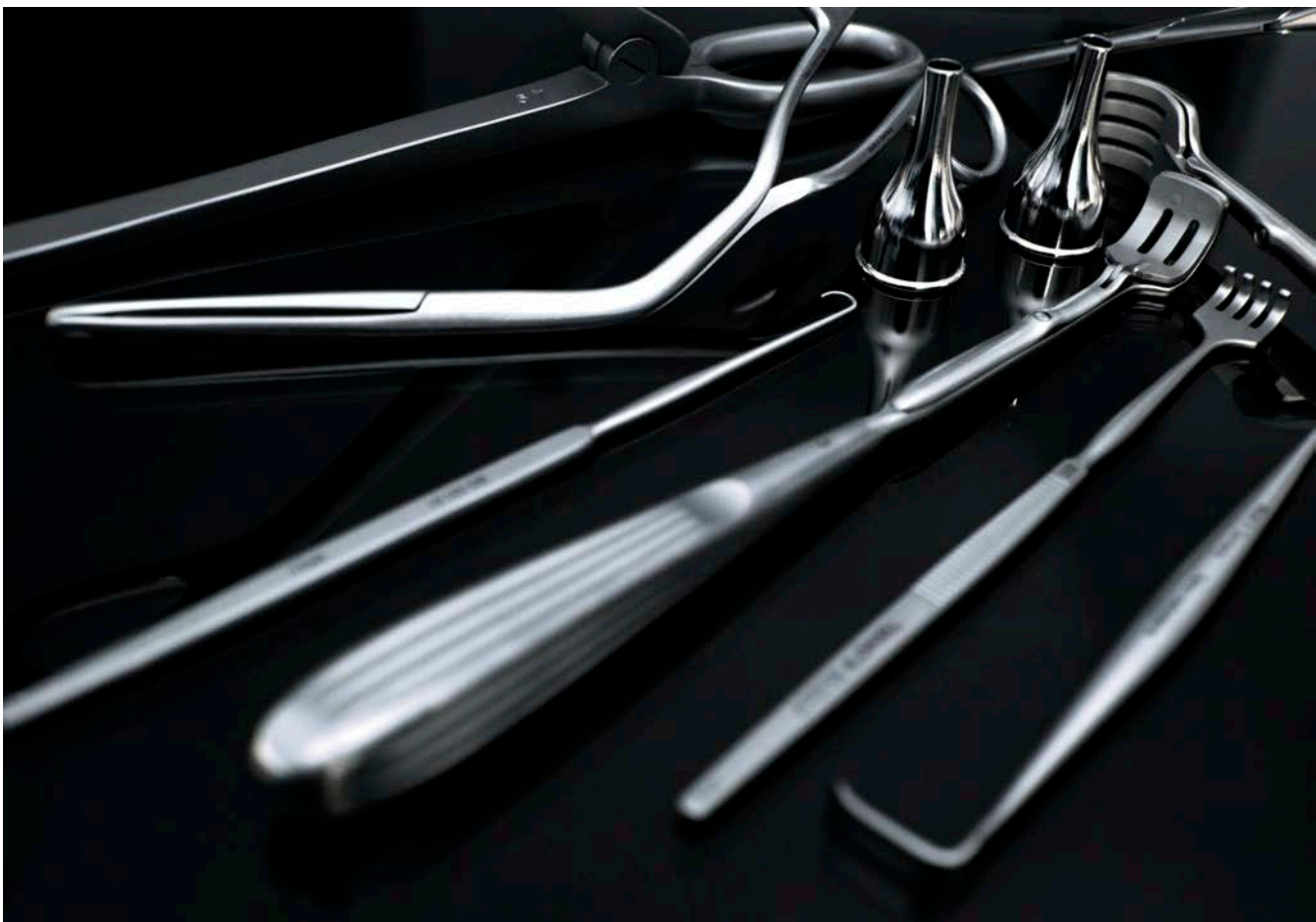

Sponge and Dressing Forceps

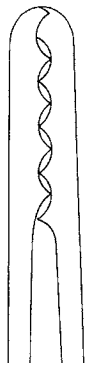
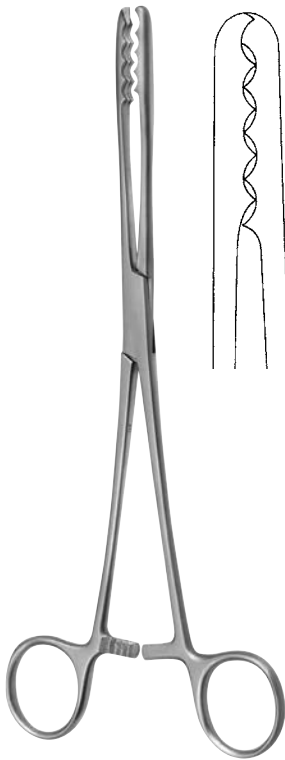

CH-700-22



CH-701-22

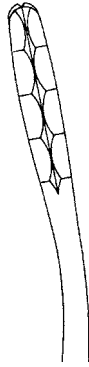

CH-700-27

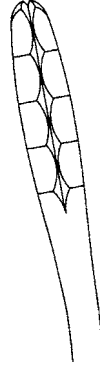
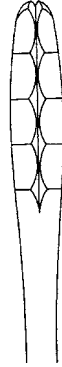

CH-701-27

ULRICH

CH-700-22 - CH-701-22 22,5 cm, 9"

CH-700-27 - CH-701-27 26,5 cm, 10 1/2"



GROSS-MAIER

CH-702-20 20,0 cm, 8"

CH-702-22 22,0 cm, 8 3/4"

CH-702-25 25,0 cm, 9 3/4"

CH-702-27 27,0 cm, 10 3/4"

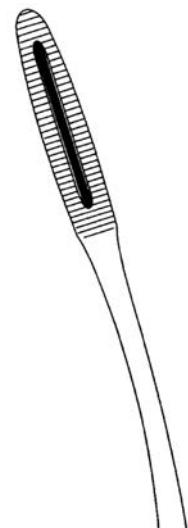

GROSS-MAIER

CH-703-20 20,0 cm, 8"

CH-703-22 22,0 cm, 8 3/4"

CH-703-25 25,0 cm, 9 3/4"

CH-703-27 27,0 cm, 10 3/4"

Sponge and Dressing Forceps



GROSS-MAIER

| | |
|------------------|-------------------|
| CH-704-20 | 20,0 cm, 8 " |
| CH-704-22 | 22,0 cm, 8 3/4 " |
| CH-704-25 | 25,0 cm, 9 3/4 " |
| CH-704-27 | 27,0 cm, 10 3/4 " |



GROSS-MAIER

| | |
|------------------|-------------------|
| CH-705-20 | 20,0 cm, 8 " |
| CH-705-22 | 22,0 cm, 8 3/4 " |
| CH-705-25 | 25,0 cm, 9 3/4 " |
| CH-705-27 | 27,0 cm, 10 3/4 " |



GROSS

| | |
|------------------|------------------|
| CH-706-14 | 14,5 cm, 5 3/4 " |
| CH-706-16 | 16,0 cm, 6 1/4 " |
| CH-706-18 | 18,0 cm, 7 " |
| CH-706-20 | 20,0 cm, 8 " |
| CH-706-25 | 25,0 cm, 9 3/4 " |



GROSS

| | |
|------------------|------------------|
| CH-707-14 | 14,5 cm, 5 3/4 " |
| CH-707-18 | 18,0 cm, 7 " |
| CH-707-20 | 20,0 cm, 8 " |
| CH-707-25 | 25,0 cm, 9 3/4 " |

Sponge Forceps



CH-736-18
CH-736-20
CH-736-25



CH-737-18
CH-737-20
CH-737-25



CH-738-18
CH-738-20
CH-738-25



CH-739-18
CH-739-20
CH-739-25

FOERSTER-BALLENGER

CH-736-18 - CH-739-18 18,0 cm, 7 "

CH-736-20 - CH-739-20 20,0 cm, 8 "

CH-736-25 - CH-739-25 25,0 cm, 9 3/4 "



CH-740-25

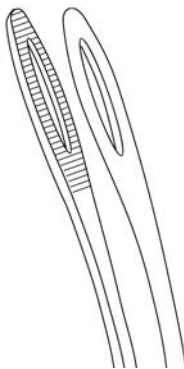

CH-741-25

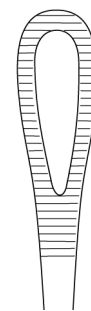

CH-742-18

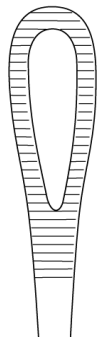

CH-742-25

FOERSTER

CH-740-25 - CH-741-25 25,0 cm, 9 3/4 "

RAMPLEY

CH-742-18 18,0 cm, 7 "

CH-742-25 25,0 cm, 9 3/4 "

Retractors

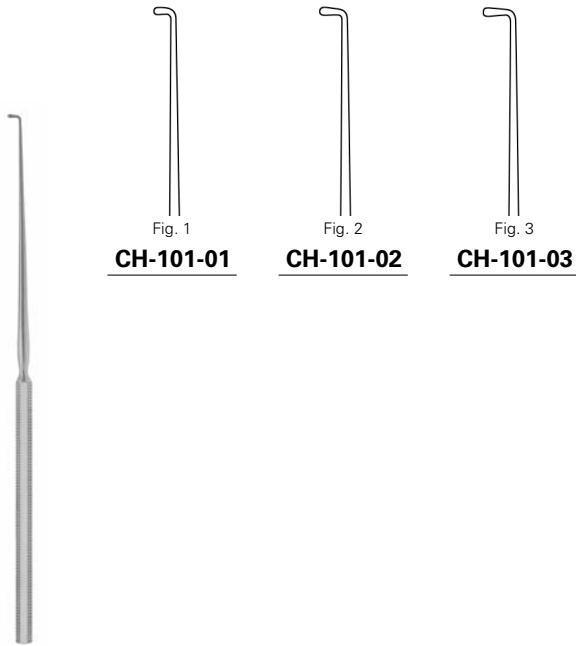

Fig. 1
CH-101-01

Fig. 2
CH-101-02

Fig. 3
CH-101-03

LUCAE

CH-101-01 - CH-101-03 14,0 cm, 5 ½"

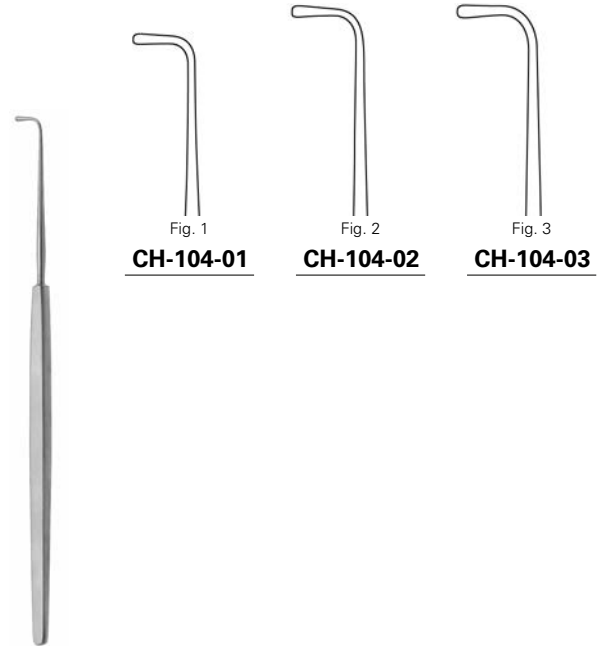

Fig. 1
CH-104-01

Fig. 2
CH-104-02

Fig. 3
CH-104-03

GRAEFE

CH-104-01 13,0 cm, 5 ⅛"

CH-104-02 - CH-104-03 14,0 cm, 5 ½"

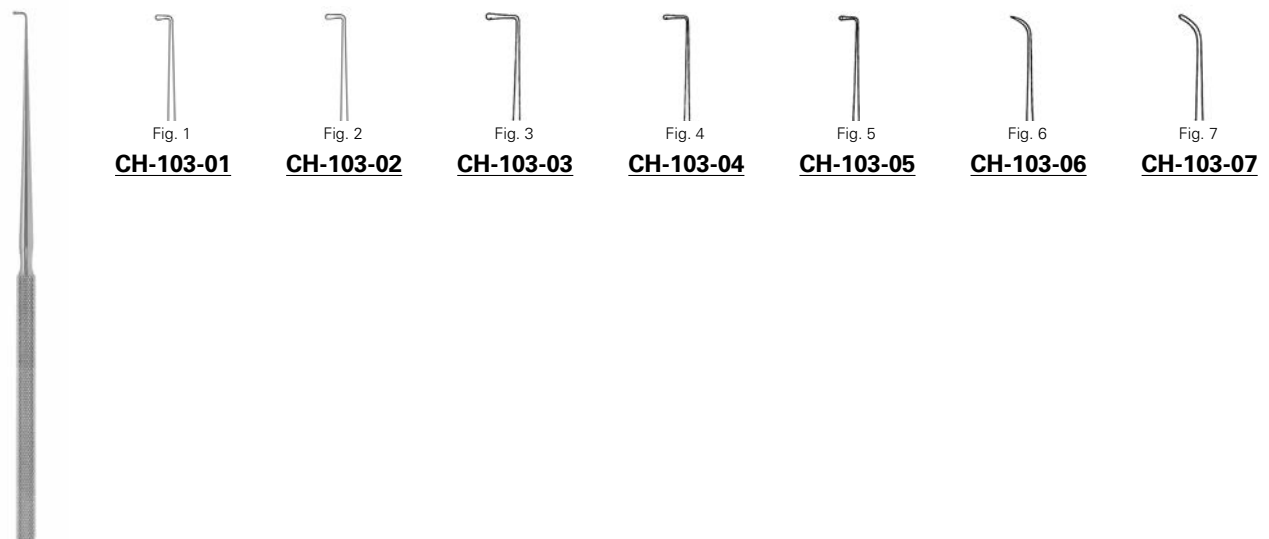

Fig. 1
CH-103-01

Fig. 2
CH-103-02

Fig. 3
CH-103-03

Fig. 4
CH-103-04

Fig. 5
CH-103-05

Fig. 6
CH-103-06

Fig. 7
CH-103-07

WAGENER

CH-103-01 - CH-103-07 14,0 cm, 5 ½"

Retractors

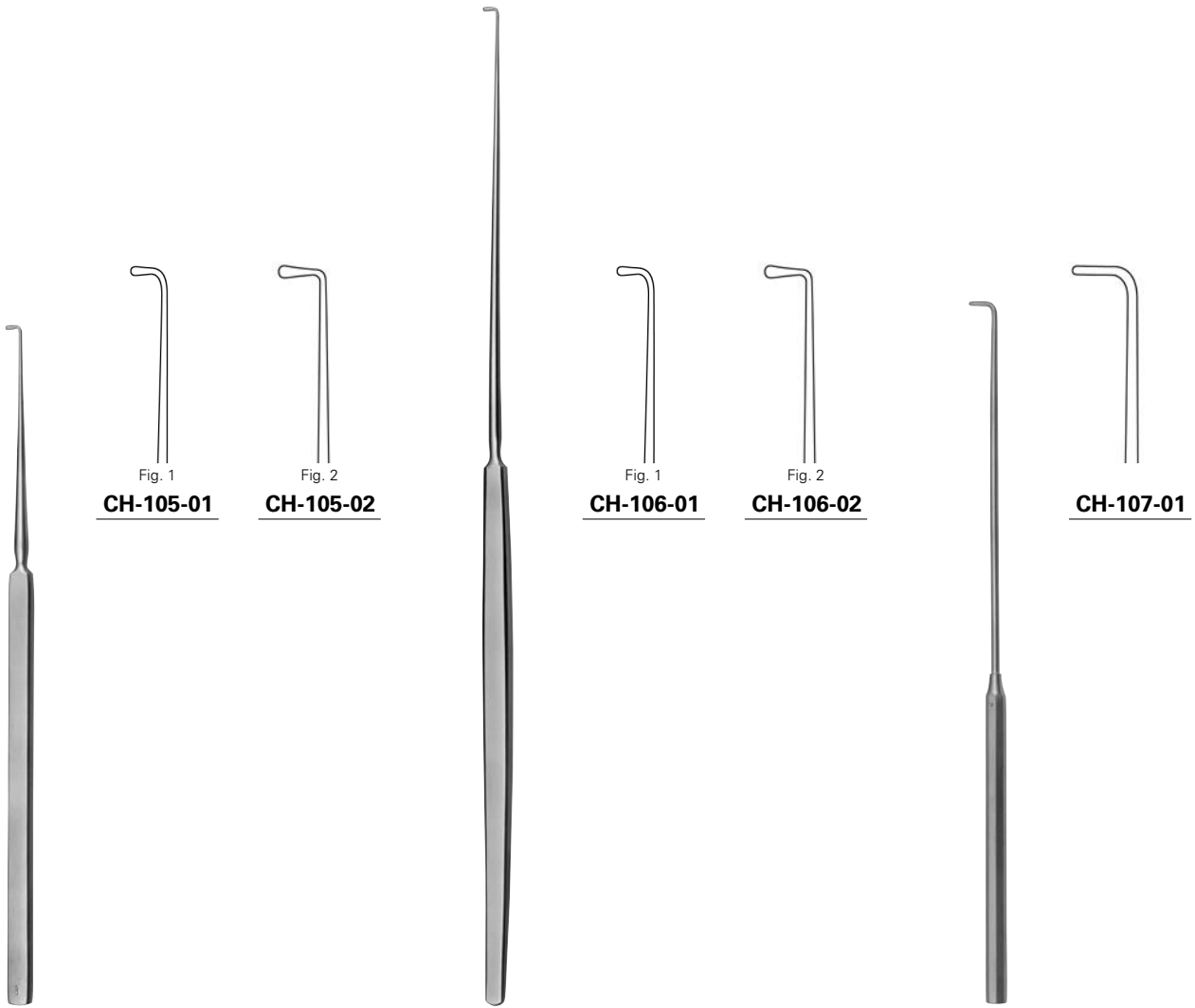

CUSHING

CH-105-01 - CH-105-02 19,0 cm, 7 ½"

CUSHING

CH-106-01 - CH-106-02 28,0 cm, 11"

CRILE

CH-107-01 20,0 cm, 8"



Retractors



CH-107-17

BROM

CH-107-17 17,0 cm, 6 3/4"



CH-108-01

Sharp



CH-109-01

Blunt



GRAEFE

CH-108-01 - CH-109-01 15,0 cm, 6"



Fig. 1

CH-110-01

Sharp



Fig. 2

CH-110-02

Sharp



Fig. 3

CH-110-03

Sharp



Fig. 4

CH-110-04

Sharp



CH-111-01

Sharp



90°

CH-111-02

Sharp



O'CONNOR

CH-111-01 - CH-111-02 16,0 cm, 6 1/4"

CH-110-01 - CH-110-04 16,0 cm, 6 1/4"

Retractors



KNAPP

CH-111-04 16,0 cm, 6 ¼"

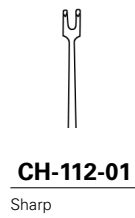

GUTHRIE

CH-112-01 - CH-112-02 16,0 cm, 6 ¼"



ROLLET

CH-112-03 - CH-112-04 13,0 cm, 5 ⅛"



CH-114-01 - CH-114-04 16,0 cm, 6 ¼"



CH-116-01 - CH-116-04 16,0 cm, 6 ¼"

Retractors



CH-117-04
Sharp



CH-118-04
Blunt

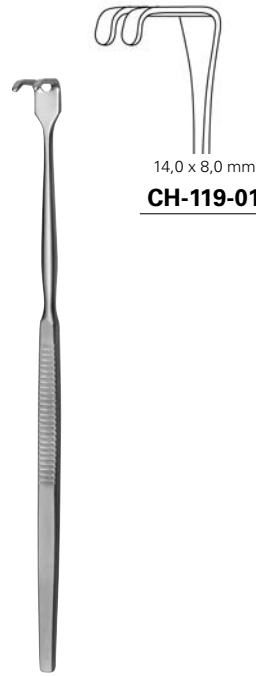

14,0 x 8,0 mm
CH-119-01

CH-117-04 - CH-118-04 16,0 cm, 6 ¼"

CH-119-01 16,0 cm, 6 ¼"



12,0 x 6,0 mm
CH-119-02



12,0 x 11,0 mm
CH-119-03



15,0 x 11,0 mm
CH-119-04



CH-119-13



KLAPP

CH-119-02 - CH-119-04 17,5 cm, 7"

MOLDESTAD

CH-119-13 13,0 cm, 5 ⅛"

Retractors

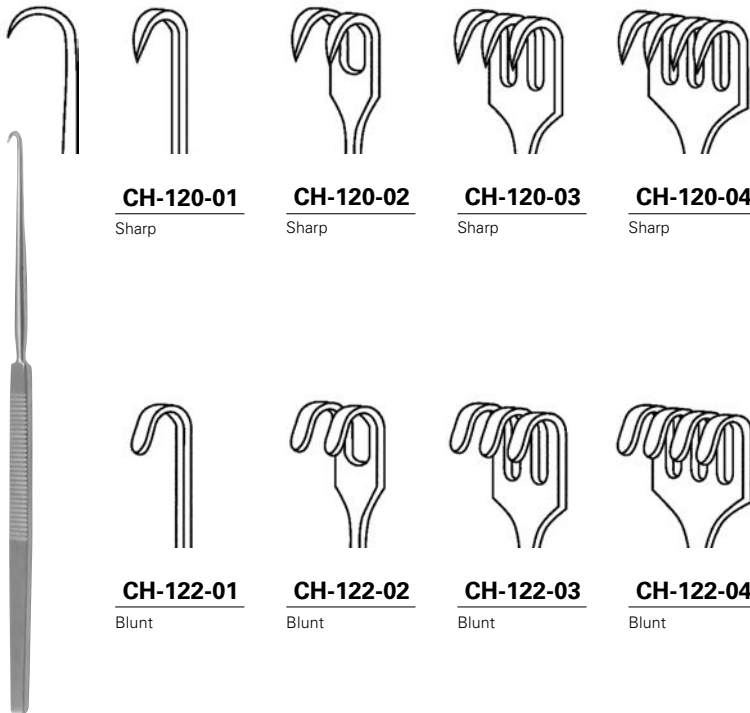

CH-120-01
Sharp

CH-120-02
Sharp

CH-120-03
Sharp

CH-120-04
Sharp

CH-122-01
Blunt

CH-122-02
Blunt

CH-122-03
Blunt

CH-122-04
Blunt

CH-120-01 - CH-122-04 16,0 cm, 6 ¼"

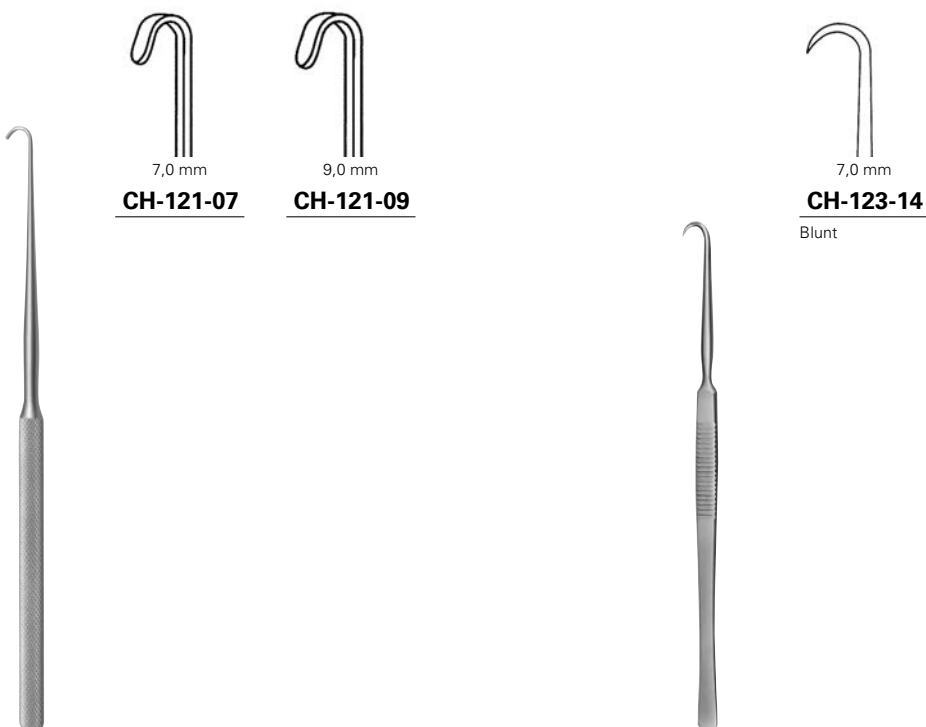

7,0 mm
CH-121-07

9,0 mm
CH-121-09

7,0 mm
CH-123-14
Blunt

CH-121-07 - CH-121-09 16,0 cm, 6 ¼"

BERGMANN

CH-123-14 14,0 cm, 5 ½"

Retractors



CH-124-01
Sharp



CH-125-01
Semi-sharp



CH-126-01
Blunt

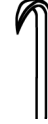

CH-124-11
Sharp



CH-125-11
Blunt



CH-124-02
Sharp



CH-125-02
Semi-sharp



CH-126-02
Blunt



CH-124-12
Sharp



CH-125-12
Blunt



CH-124-03
Sharp



CH-125-03
Semi-sharp



CH-126-03
Blunt



CH-124-13
Sharp



CH-125-13
Blunt



CH-124-04
Sharp



CH-125-04
Semi-sharp



CH-126-04
Blunt



CH-124-14
Sharp



CH-125-14
Blunt



CH-124-01 - CH-126-04 16,5 cm, 6 1/2"

CH-124-11 - CH-125-14 16,5 cm, 6 1/2"

Retractors

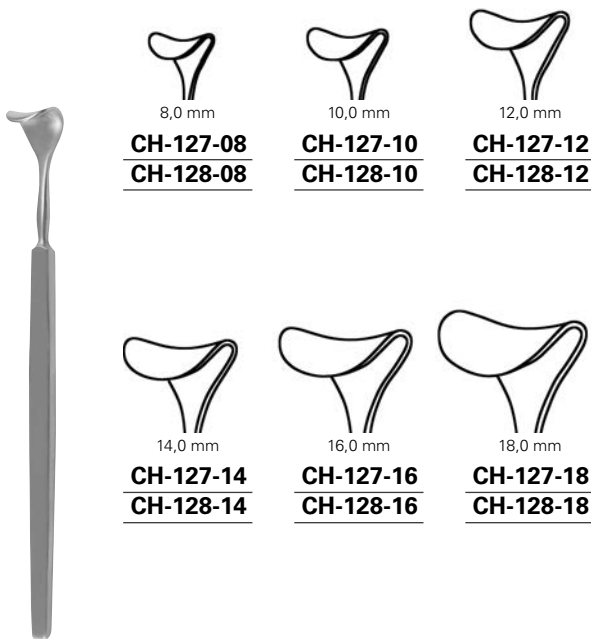

8,0 mm
CH-127-08
CH-128-08

10,0 mm
CH-127-10
CH-128-10

12,0 mm
CH-127-12
CH-128-12

14,0 mm
CH-127-14
CH-128-14

16,0 mm
CH-127-16
CH-128-16

18,0 mm
CH-127-18
CH-128-18

DESMARRES

CH-127-08 - CH-127-18 13,0 cm, 5 1/8 "
CH-128-08 - CH-128-18 16,0 cm, 6 1/4 "

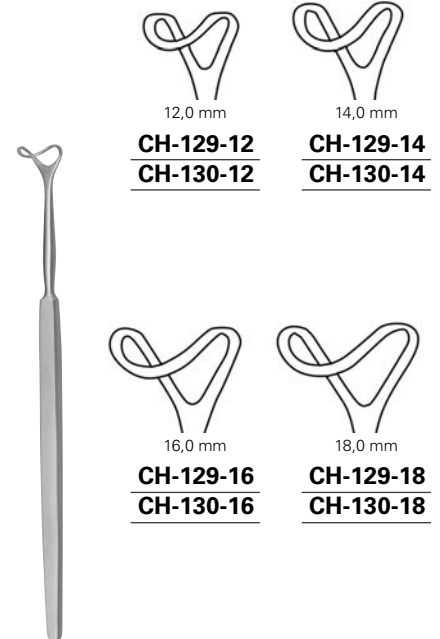

12,0 mm
CH-129-12
CH-130-12

14,0 mm
CH-129-14
CH-130-14

16,0 mm
CH-129-16
CH-130-16

18,0 mm
CH-129-18
CH-130-18

DESMARRES

CH-129-12 - CH-129-18 13,0 cm, 5 1/8 "
CH-130-12 - CH-130-18 16,0 cm, 6 1/4 "

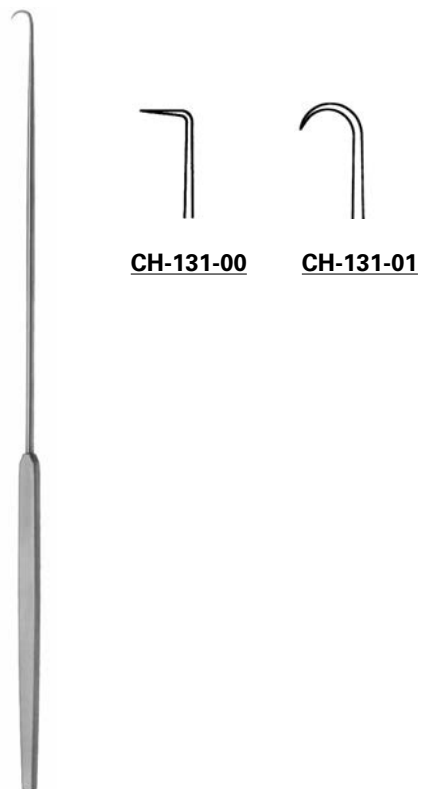

CH-131-00

CH-131-01

EMMET

CH-131-00 - CH-131-01 22,0 cm, 8 3/4 "

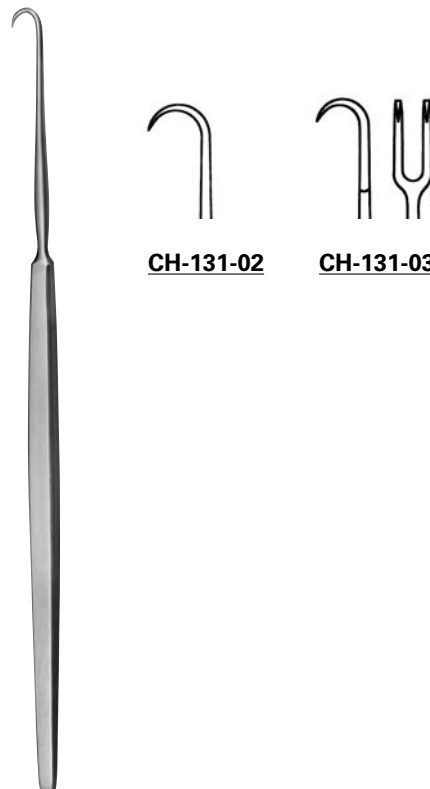

CH-131-02

CH-131-03

SIMON

CH-131-02 - CH-131-03 22,0 cm, 8 3/4 "

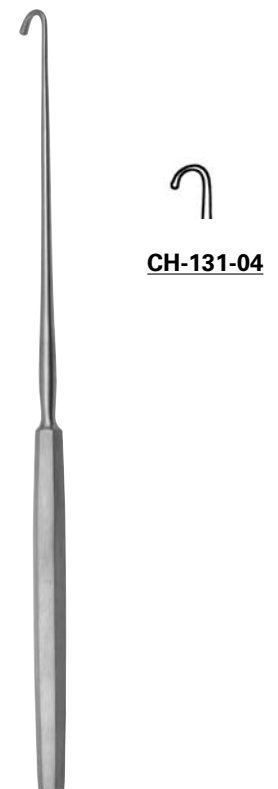

CH-131-04

LANGE

CH-131-04 23,0 cm, 9 "

Retractors



KOENIG

CH-132-01 - CH-132-02 18,0 cm, 7"

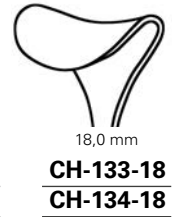
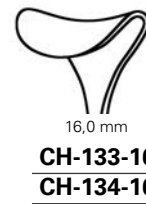

CUSHING

CH-133-08 - CH-133-08 20,0 cm, 8"

CH-134-08 - CH-134-08 24,0 cm, 9 1/2"



CUSHING-KOCHER

CH-135-10 20,0 cm, 8"



20,0 x 15,0 mm
CH-135-20
20,0 x 19,0 mm

CH-135-20 20,5 cm, 8"

Retractors



CH-136-08



CH-136-11



CH-136-13



CH-136-15



CH-136-17



CH-136-29

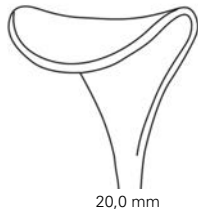

CH-136-20

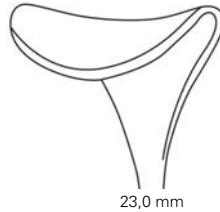

CH-136-23

malleable shaft



malleable shaft

GILL-VERNET

CH-136-08 - CH-136-23 24,0 cm, 9 1/2"

KIRKLIN

CH-136-29 13,5 cm, 5 1/4"



28,0 x 6,0 mm
CH-137-19



12,0 x 14,0 mm
CH-137-20

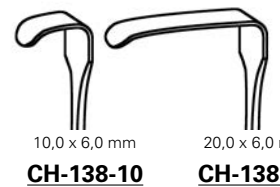

10,0 x 6,0 mm
CH-138-10

20,0 x 6,0 mm
CH-138-20

LAHEY

CH-137-19 19,0 cm, 7 1/2"

LITTLE

CH-137-20 20,0 cm, 8"

SENN-GREEN

CH-138-10 - CH-138-20 15,0 cm, 6"

Retractors



22,0 x 7,0 mm

CH-139-01

Sharp

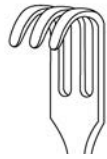

22,0 x 7,0 mm

CH-139-02

Blunt



18,0 x 6,0 mm

CH-139-03

Sharp



SENN-MILLER

CH-139-01 - CH-139-03 16,0 cm, 6 1/4 "



13,0 x 5,0 mm

CH-139-04

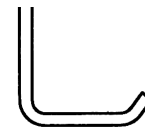

KILNER

CH-139-04 15,5 cm, 6 "



10,0 x 6,0 mm

CH-140-10



17,0 x 5,0 mm

CH-140-17



20,0 x 6,0 mm

CH-140-20



22,0 x 8,0 mm

CH-140-22

MINI-LANGENBECK

CH-140-10 - CH-140-22 16,0 cm, 6 1/4 "



CH-141-01

Sharp



CH-141-02

Sharp

CH-141-01 - CH-141-02 16,0 cm, 6 1/4 "

Retractors

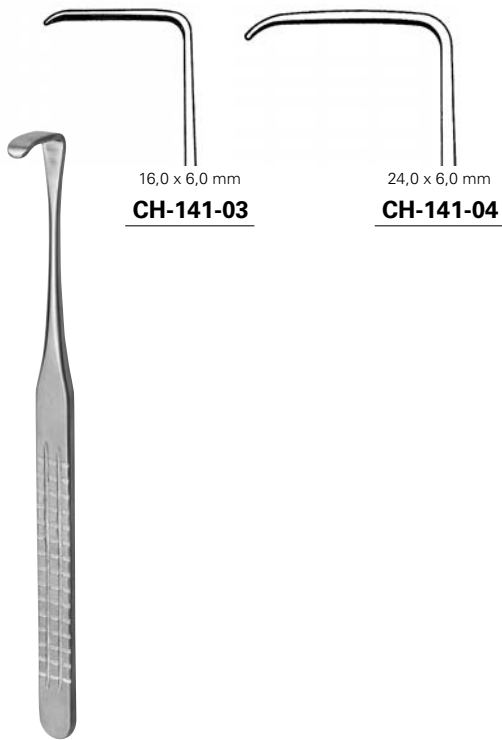

CH-141-03 - CH-141-04 16,0 cm, 6 ¼"

CH-141-05 16,0 cm, 6 ¼"

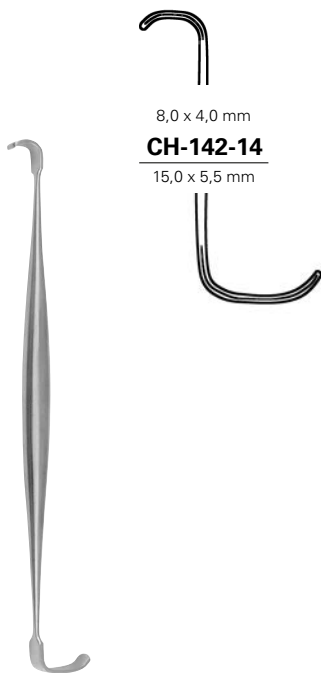

RAGNELL-DAVIS

CH-142-14 14,0 cm, 5 ½"

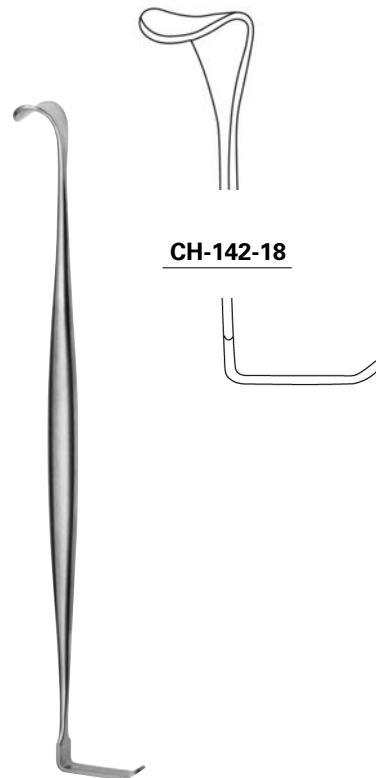

COPE

CH-142-18 18,0 cm, 7"

Retractors



CH-143-01

CH-143-02

STRANDELL-STILLE

CH-143-01 - CH-143-02 19,0 cm, 7 1/2"

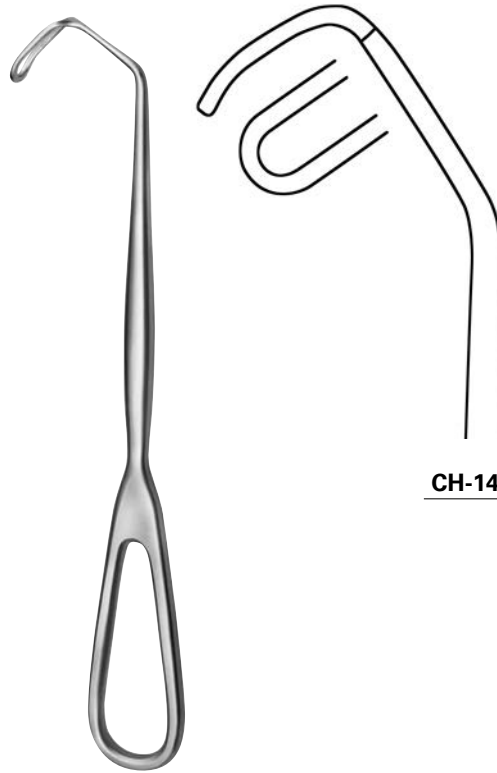

CH-144-20

CUSHING

CH-144-20 20,0 cm, 8"



11,0 x 12,0 mm

CH-144-21

CUSHING

CH-144-21 21,0 cm, 8 1/4"



18,0 x 7,0 mm

CH-145-01



16,0 x 5,0 mm

CH-145-02



7,0 x 4,0 mm

CH-145-03



10,0 x 3,0 mm

CH-145-04



7,0 x 4,0 mm

CH-145-05



10,0 x 4,0 mm

CH-145-06

MEYERDING

CH-145-01 - CH-145-06 18,0 cm, 7"

Retractors



50 x 11 mm

CH-018-07



50 x 11 mm

CH-018-17



40 x 13 mm

CH-018-06



43 x 13 mm

CH-018-16

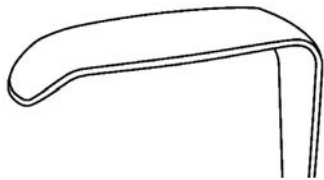

40 x 11 mm

CH-018-05



40 x 11 mm

CH-018-15

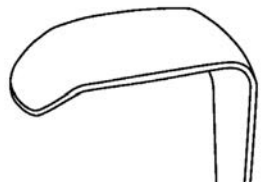

33 x 14 mm

CH-018-04

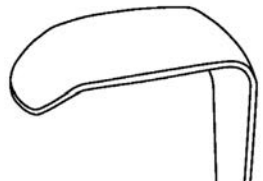

30 x 16 mm

CH-018-03

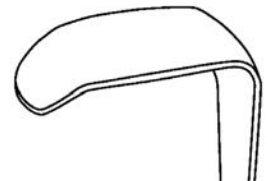

30 x 16 mm

CH-018-13

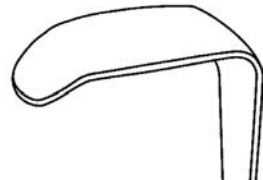

30 x 14 mm

CH-018-02

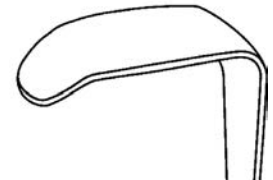

30 x 14 mm

CH-018-12

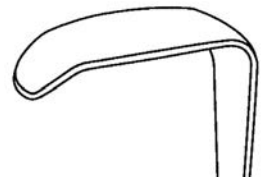

30 x 11 mm

CH-018-01

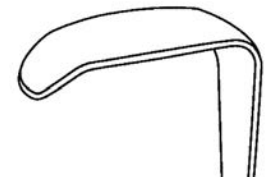

30 x 11 mm

CH-018-11



LANGENBECK

CH-018-01 - CH-018-07 22,5 cm, 8 3/4"



LANGENBECK

CH-018-11 - CH-018-17 22,5 cm, 8 3/4"

Retractors

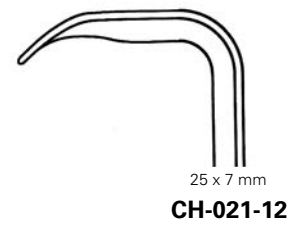
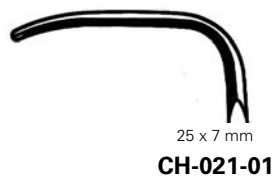
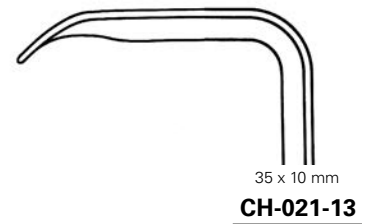
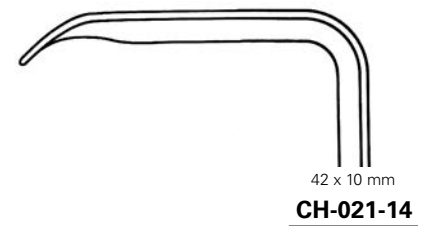
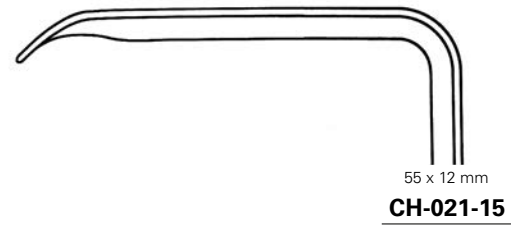
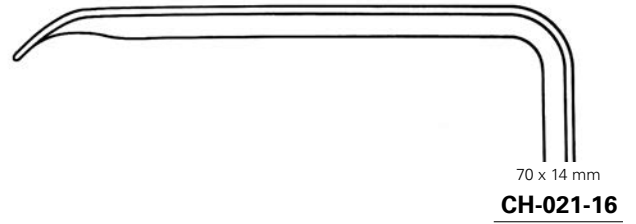
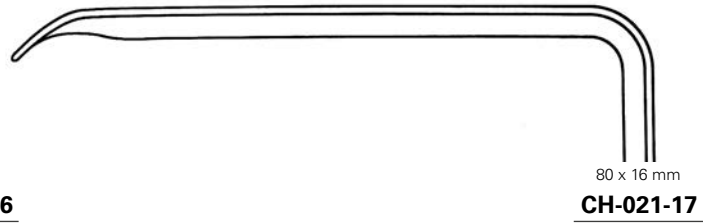

Soft tissue retractors



Soft tissue retractors

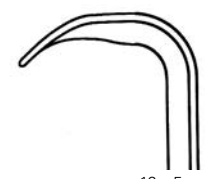

OBWEGESER

CH-021-01 - CH-021-06 21,5 cm, 8 ½"

OBWEGESER

CH-021-11 - CH-021-17 24,0 cm, 9 ½"

Wound Spreaders, Self Retaining

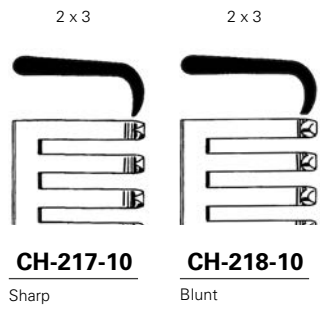
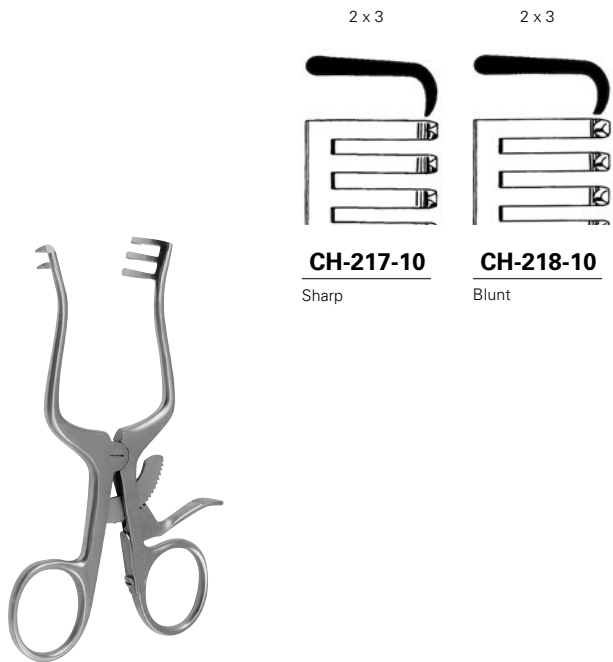

WEITLANER

CH-217-10 - CH-218-10 11,0 cm, 4 ¼"

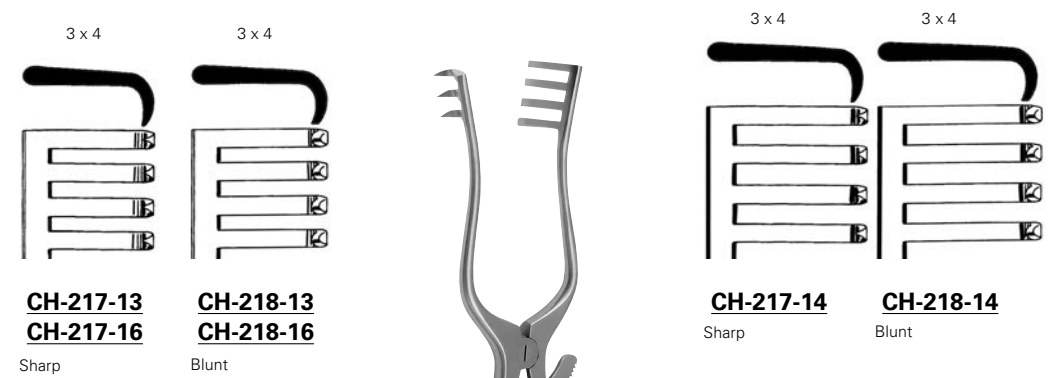
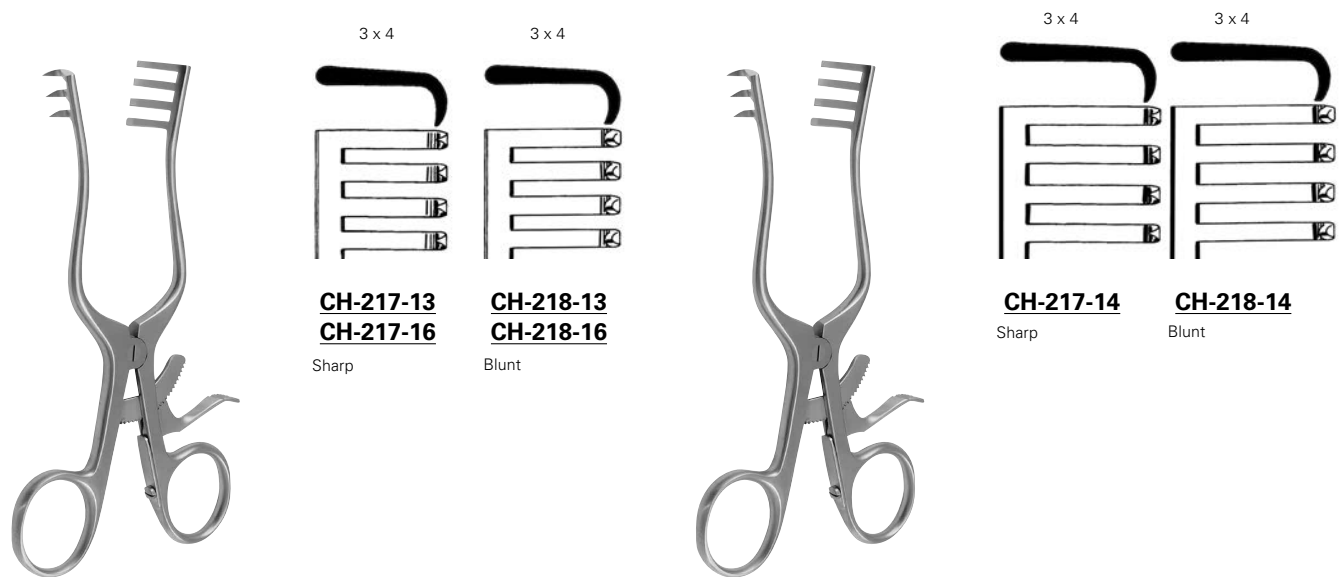

WEITLANER

CH-217-13 - CH-218-13 13,5 cm, 5 ¼"
CH-217-16 - CH-218-16 16,0 cm, 6 ¼"

WEITLANER

CH-217-14 - CH-218-14 13,5 cm, 5 ¼"

Wound Spreaders, Self Retaining

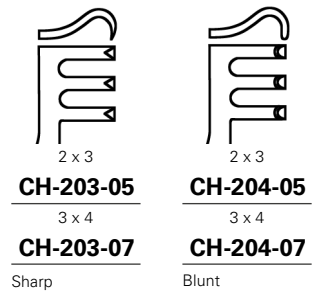

MUELLER

CH-201-05 6,5 cm, 2 1/3"



BOSE

CH-202-06 6,0 cm, 2 1/4"



FINZEN

CH-203-05 - CH-204-05 5,0 cm, 2"
CH-203-07 - CH-204-07 7,0 cm, 2 3/4"

3 x 4



CH-206-07
Sharp

3 x 4



CH-207-07
Blunt



FINZEN

CH-206-07 - CH-207-07 7,0 cm, 2 3/4"

4 x 4



CH-209-10
Sharp

4 x 4



CH-210-10
Blunt



HOLZHEIMER

CH-209-10 - CH-210-10 10,0 cm, 4"

Wound Spreaders, Self Retaining



4 x 4

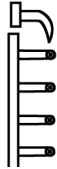

CH-212-07
CH-212-10

Sharp

4 x 4

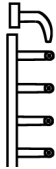

CH-213-07
CH-213-10

Blunt



3 x 3

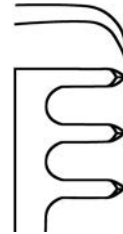

CH-214-06

Sharp

3 x 3

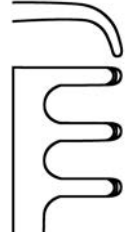

CH-215-06

Blunt

ALM

CH-212-07 - CH-213-07 7,0 cm, 2 3/4"
CH-212-10 - CH-213-10 10,0 cm, 4"

JANSEN

CH-214-06 - CH-215-06 10,0 cm, 4"



3 x 4

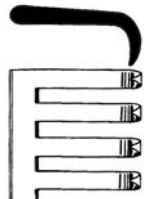

CH-216-14

Sharp

3 x 4

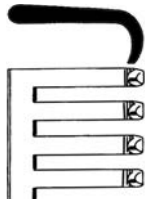

CH-216-15

Blunt



2 x 3

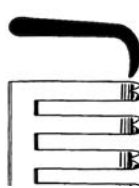

CH-217-10

Sharp

2 x 3

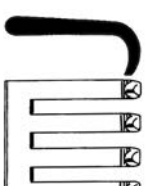

CH-218-10

Blunt

SCALP-CONTOUR

CH-216-14 - CH-216-15 14,0 cm, 5 1/2"

WEITLANER

CH-217-10 - CH-218-10 11,0 cm, 4 1/4"

Needle Holders



CH-034-12

DERF-CONVERSE

CH-034-12 12,0 cm, 4 3/4"



CH-035-12

DOYEN

CH-035-12 12,5 cm, 5"



CH-036-12

COLLIER

CH-036-12 12,0 cm, 4 3/4"



CH-012-15

CRILE-MURRAY

CH-012-15 15,0 cm, 6"



CH-014-15
CH-014-18
CH-014-20
CH-014-23

CRILE-WOOD

CH-014-15 15,0 cm, 6"
CH-014-18 18,0 cm, 7"
CH-014-20 20,0 cm, 8"
CH-014-23 23,0 cm, 9"



CH-018-13
CH-018-18

BROWN

CH-018-13 13,0 cm, 5 1/8"
CH-018-18 18,0 cm, 7"





Needle Holders with Tungsten Carbide Inserts

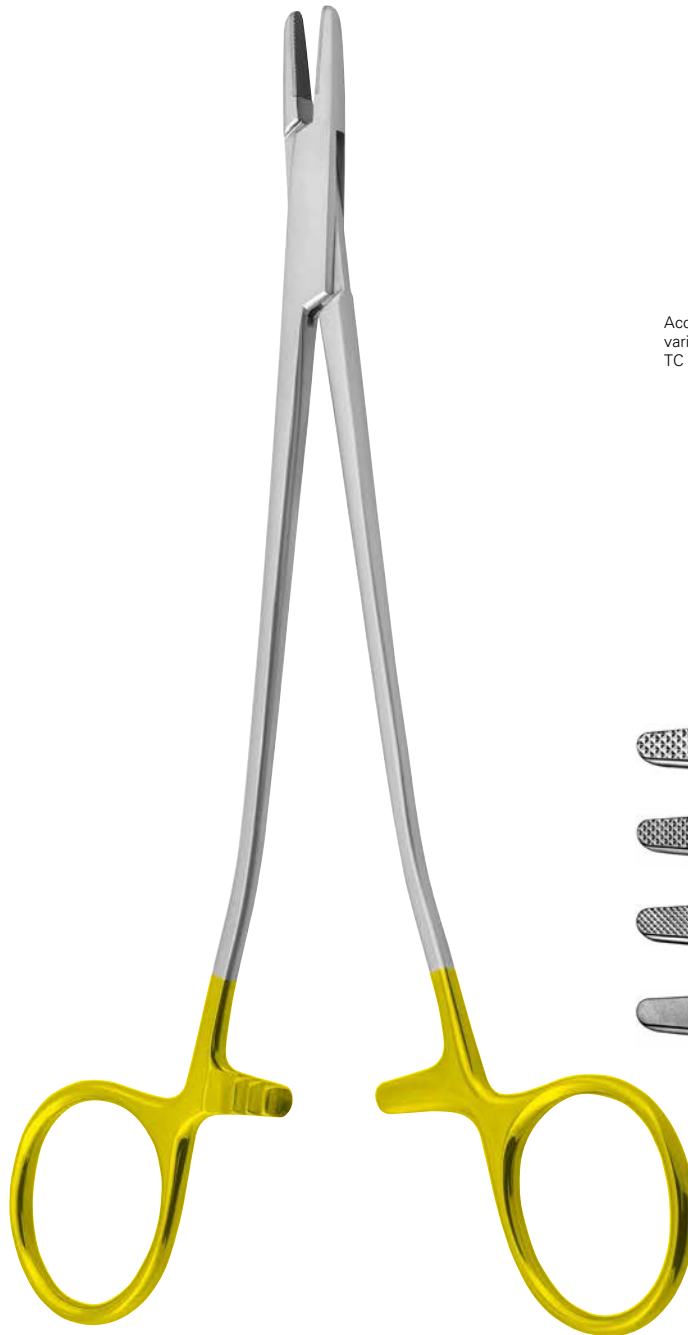

Characteristic: golden rings



According to the field of application, there are various types of tungsten carbide inserts for TC needle holders:

| For suture material | Serration |
|---|--|
|  | A 0,6 - 4,0 0,5 mm |
|  | B 4,0 - 6,0 0,4 mm |
|  | C 5,0 - 12,0 0,3 mm |
|  | G 5,0 - 12,0 glatt smoth liso liscie |

- Tungsten carbide inserts with precisely worked out structure guarantee a secure grip of the needle.
- Bevelled edges to prevent catching of suture material.
- Soft working catch provides safe handling.

Needle Holders with Tungsten Carbide Inserts



A
0,6-4,0

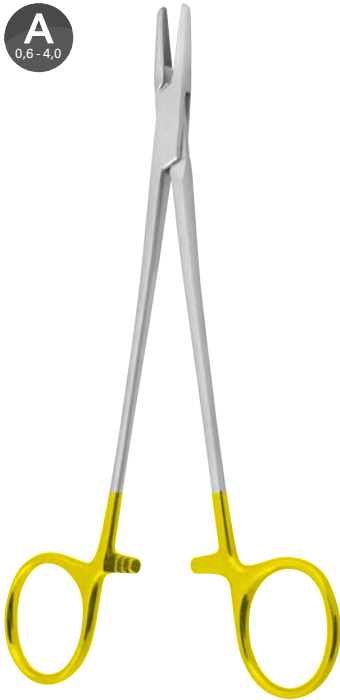

CH-000-18



CH-000-20



CH-000-24

HEGAR

CH-000-18 18,0 cm, 7"

CH-000-20 20,0 cm, 8"

CH-000-24 24,0 cm, 9 1/2"



CH-002-14



CH-002-16



CH-002-18



CH-002-20



CH-002-24



CH-002-26

A
0,6-4,0



MAYO-HEGAR

CH-002-14 14,0 cm, 5 1/2"

CH-002-16 16,0 cm, 6 1/4"

CH-002-18 18,0 cm, 7"

CH-002-20 20,0 cm, 8"

CH-002-24 24,0 cm, 9 1/2"

CH-002-26 26,0 cm, 10 1/4"

CH-002-30 30,0 cm, 11 3/4"

CH-002-36 36,0 cm, 14"

CH-002-40 40,0 cm, 16"



CH-002-30



CH-002-36



CH-002-40

Needle Holders with Tungsten Carbide Inserts

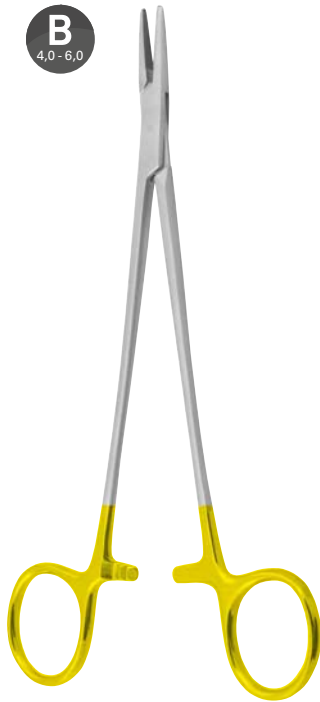

CH-004-15



CH-004-16



CH-004-18



CH-004-20



CH-004-23



CH-004-26

DE BAKEY

| | |
|------------------|------------------|
| CH-004-15 | 15,0 cm, 6" |
| CH-004-16 | 16,0 cm, 6 1/4" |
| CH-004-18 | 18,0 cm, 7" |
| CH-004-20 | 20,0 cm, 8" |
| CH-004-23 | 23,0 cm, 9" |
| CH-004-26 | 26,0 cm, 10 1/4" |
| CH-004-31 | 31,0 cm, 12 1/2" |
| CH-004-37 | 37,0 cm, 14 1/2" |



CH-004-31



CH-004-37

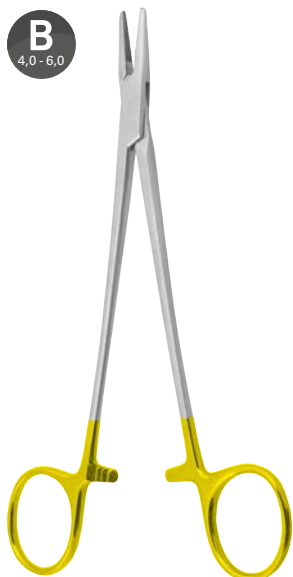

CH-012-15



CH-012-18



CH-012-20



CH-012-23



CH-012-36



CH-012-40

CRILE-WOOD

| | |
|------------------|--------------|
| CH-012-15 | 15,0 cm, 6" |
| CH-012-18 | 18,0 cm, 7" |
| CH-012-20 | 20,0 cm, 8" |
| CH-012-23 | 23,0 cm, 9" |
| CH-012-36 | 36,0 cm, 14" |
| CH-012-40 | 40,0 cm, 16" |

Needle Holders with Tungsten Carbide Inserts



B
4,0 - 6,0



CH-005-20



CH-005-25

DE BAKEY

CH-005-20 20,0 cm, 8"

CH-005-25 25,0 cm, 9 3/4"

B
4,0 - 6,0

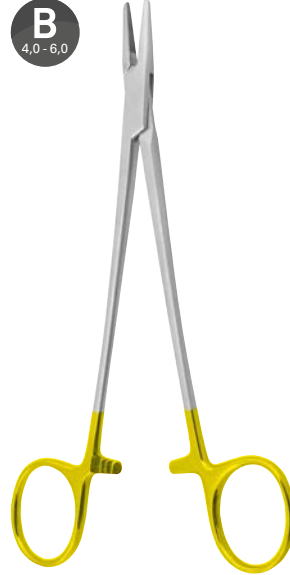

CH-014-15

BABY-CRILE-WOOD

CH-014-15 15,0 cm, 6"

B
4,0 - 6,0

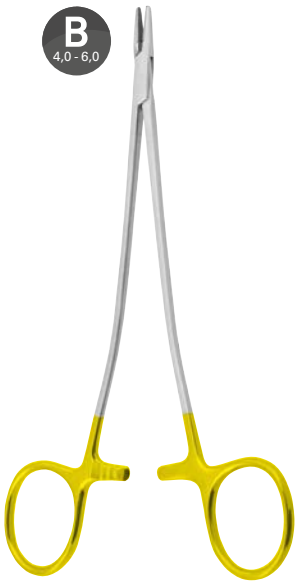

CH-016-15



CH-016-17



CH-016-20

SENNING

CH-016-15 15,0 cm, 6"

CH-016-17 17,0 cm, 6 3/4"

CH-016-20 20,0 cm, 8"

G
5,0 - 12,0



CH-018-15

CRILE-WOOD

CH-018-15 15,0 cm, 6"

Needle Holders with Tungsten Carbide Inserts



A
0,6 - 4,0

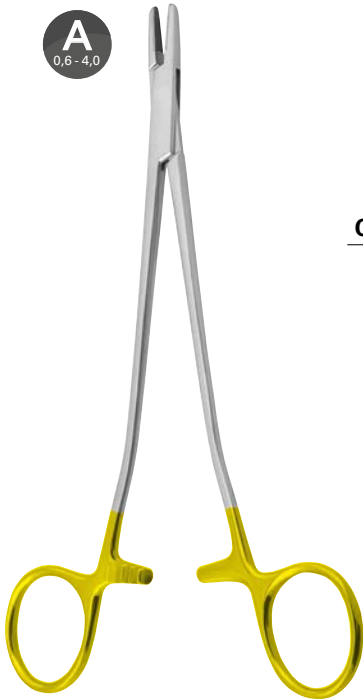

CH-020-18



CH-020-20



CH-020-26



CH-022-13
CH-022-14

B
4,0 - 6,0



SAROT

- CH-020-18** 18,0 cm, 7 "
- CH-020-20** 20,0 cm, 8 "
- CH-020-26** 26,0 cm, 10 ¼ "

HEGAR-BAUMGARTNER

- CH-022-13** 13,0 cm, 5 ⅛ "
- CH-022-14** 14,0 cm, 5 ½ "

B
4,0 - 6,0



CH-024-13



CH-026-13



CH-028-13

B
4,0 - 6,0

G
5,0 - 12,0

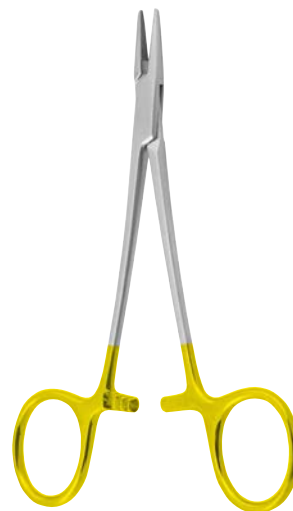

NEIVERT-MASING

- CH-024-13** 13,0 cm, 5 ⅛ "

HALSEY

- CH-026-13 - CH-028-13** 13,0 cm, 5 ⅛ "

Needle Holders with Tungsten Carbide Inserts



CH-030-13



CH-031-13



CH-032-12

WEBSTER

CH-030-13 13,0 cm, 5 1/8"

KILNER

CH-031-13 13,0 cm, 5 1/8"

DERF

CH-032-12 12,0 cm, 4 3/4"

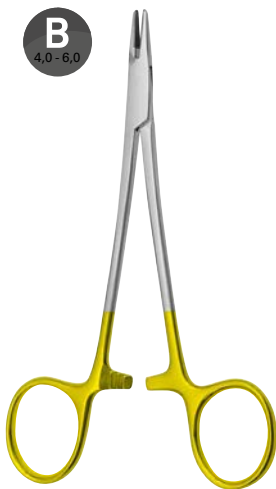

CH-034-12



CH-036-13



CH-036-15

DERF-CONVERSE

CH-034-12 12,0 cm, 4 3/4"

CH-036-13 13,0 cm, 5 1/8"

CH-036-15 15,0 cm, 6"

Needle Holders with Tungsten Carbide Inserts



A
0,6 - 4,0

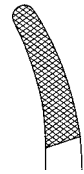

CH-037-20
CH-037-24
CH-037-26
CH-037-36

HEANEY

CH-037-20 20,0 cm, 8 "
CH-037-24 24,0 cm, 9 1/2 "
CH-037-26 26,0 cm, 10 1/4 "
CH-037-36 36,0 cm, 14 1/4 "

A
0,6 - 4,0

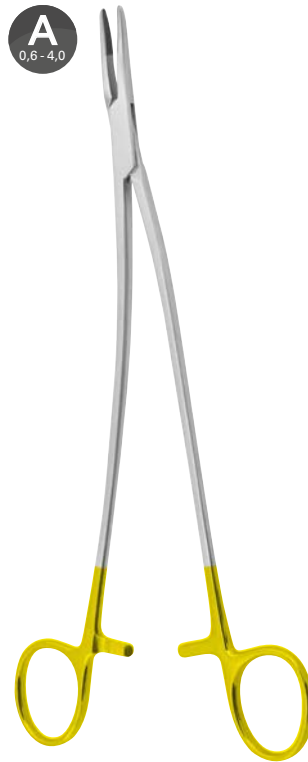

CH-039-22

CH-039-23

STRATTE

CH-039-22 22,0 cm, 8 3/4 "
CH-039-23 23,0 cm, 9 "

A
0,6 - 4,0

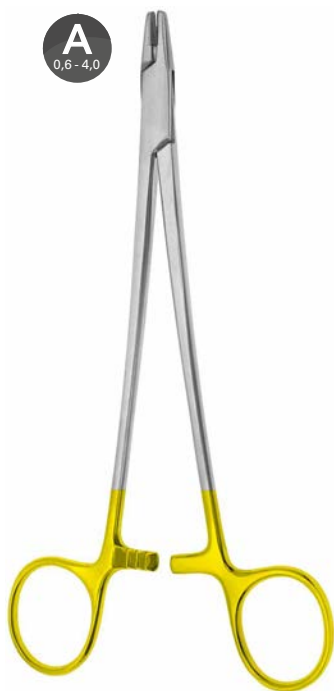

CH-040-18

NEW ORLEANS

CH-040-18 18,0 cm, 7 "

A
0,6 - 4,0

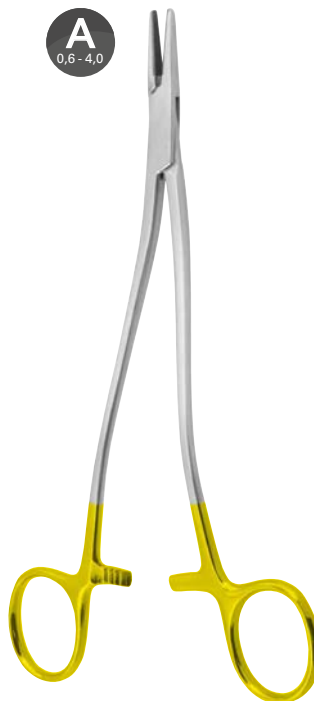

CH-041-20

CH-041-24



CH-041-26

CH-041-28

BOZEMANN-S

CH-041-20 20,0 cm, 8 "
CH-041-24 24,0 cm, 9 1/2 "
CH-041-26 26,0 cm, 10 1/4 "
CH-041-28 28,0 cm, 11 "

Needle Holders with Tungsten Carbide Inserts

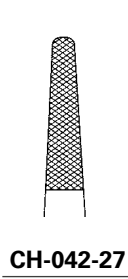

MASSON

CH-042-27 27,0 cm, 10 $\frac{3}{4}$ "

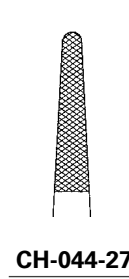

WANGENSTEEN

CH-044-27 27,0 cm, 10 $\frac{3}{4}$ "

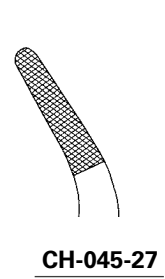

FINOCHIETTO

CH-045-27 27,0 cm, 10 $\frac{3}{4}$ "



OLSEN-HEGAR

CH-046-12 - CH-046-13 13,0 cm, 5 $\frac{1}{8}$ "

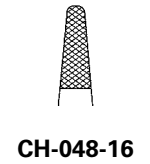
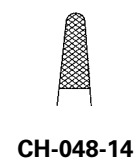

OLSEN-HEGAR

CH-048-14 14,0 cm, 5 $\frac{1}{2}$ "
CH-048-16 16,5 cm, 6 $\frac{1}{2}$ "
CH-048-18 18,0 cm, 7"

Needle Holders with Tungsten Carbide Inserts



CH-049-11



CH-051-15



CH-051-16

G
5,0 - 12,0



FOSTER-GILLIES

CH-049-11 11,0 cm, 4 3/8"

B
4,0 - 6,0



GILLIES-MINI

CH-051-15 15,0 cm, 6"

A
0,6 - 4,0



GILLIES

CH-051-16 16,0 cm, 6 1/4"

A
0,6 - 4,0



MATHIEU

CH-052-14 14,0 cm, 5 1/2"

CH-052-17 17,0 cm, 6 3/4"

CH-052-20 20,0 cm, 8"



CH-052-14



CH-052-17



CH-052-20

A
0,6 - 4,0



MATHIEU

CH-053-14 14,0 cm, 5 1/2"

CH-053-17 17,0 cm, 6 3/4"

CH-053-20 20,0 cm, 8"



CH-053-14



CH-053-17



CH-053-20

Needle Holders with Tungsten Carbide Inserts



A
0,6 - 4,0

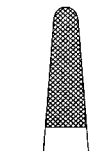

CH-053-21



CH-053-25

A
0,6 - 4,0

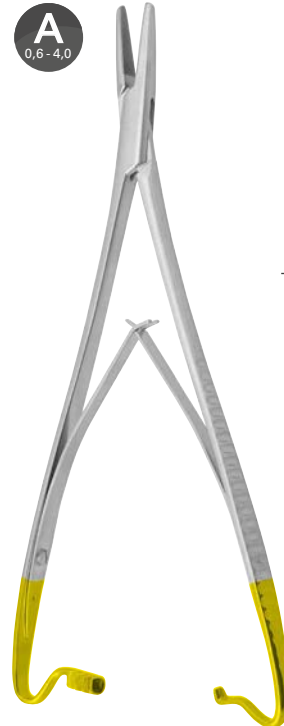

CH-053-37



CH-053-40



CH-053-44

MATHIEU

- CH-053-21** 20,0 cm, 8"
- CH-053-25** 24,5 cm, 9 2/3"

MATHIEU

- CH-053-37** 17,0 cm, 6 3/4"
- CH-053-40** 20,0 cm, 8"
- CH-053-44** 24,0 cm, 9 1/2"

A
0,6 - 4,0



CH-054-14



CH-054-17



CH-054-20

B
4,0 - 6,0



CH-055-14



CH-055-17



CH-055-20

MATHIEU

- CH-054-14** 14,0 cm, 5 1/2"
- CH-054-17** 17,0 cm, 6 3/4"
- CH-054-20** 20,0 cm, 8"

MATHIEU

- CH-055-14** 14,0 cm, 5 1/2"
- CH-055-17** 17,0 cm, 6 3/4"
- CH-055-20** 20,0 cm, 8"

Needle Holders with Tungsten Carbide Inserts



A
0,6 - 4,0



CH-056-20



CH-057-20

CH-057-26



A
0,6 - 4,0

B
4,0 - 6,0



LICHTENBERG

CH-056-20 20,0 cm, 8"

CH-057-20 20,0 cm, 8"
CH-057-26 26,0 cm, 10 1/4"

B
4,0 - 6,0



CH-058-26



A
0,6 - 4,0



CH-066-20

CH-066-23



HOESEL

CH-058-26 26,0 cm, 10 1/4"

ZWEIFEL

CH-066-20 20,0 cm, 8"
CH-066-23 23,0 cm, 9"

Needle Holders with Tungsten Carbide Inserts



A
0,6 - 4,0



CH-070-18



A
0,6 - 4,0



CH-071-18



TOENNIS

CH-070-18 18,0 cm, 7"

TOENNIS Modif.

CH-071-18 18,0 cm, 7"

A
0,6 - 4,0



CH-072-18



CH-072-20



CH-072-23



A
0,6 - 4,0



CH-076-16



CH-077-16



LANGENBECK

CH-072-18 18,0 cm, 7"

CH-072-20 20,0 cm, 8"

CH-072-23 23,0 cm, 9"

ARRUGA

CH-076-16 - CH-077-16 16,0 cm, 6 3/8"

Needle Holders with Tungsten Carbide Inserts

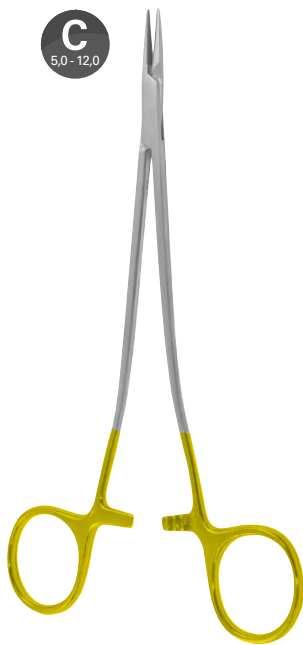

HEGAR-VASCULAR

| | |
|------------------|-----------------|
| CH-100-14 | 14,0 cm, 5 1/2" |
| CH-100-18 | 18,0 cm, 7" |
| CH-100-20 | 20,0 cm, 8" |
| CH-100-23 | 23,0 cm, 9" |

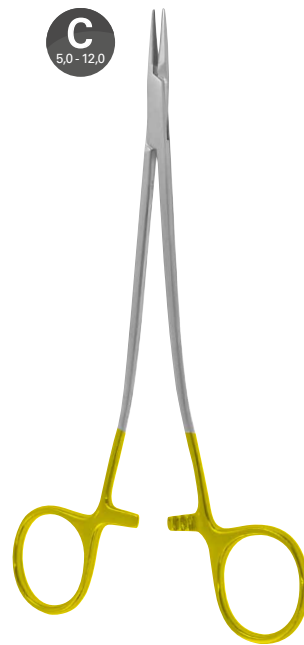
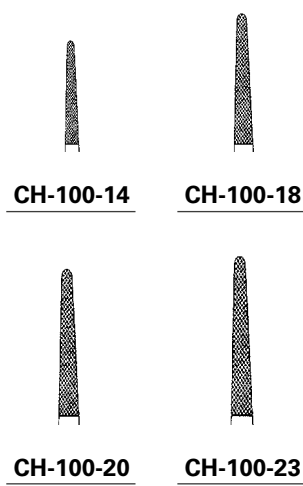

HEGAR-VASCULAR

| | |
|------------------|-----------------|
| CH-102-14 | 14,0 cm, 5 1/2" |
| CH-102-16 | 16,0 cm, 6 1/4" |
| CH-102-18 | 18,0 cm, 7" |
| CH-102-20 | 20,0 cm, 8" |

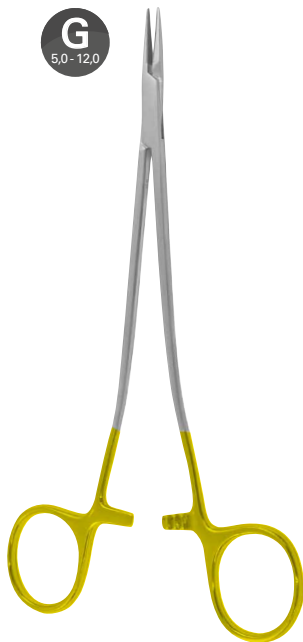
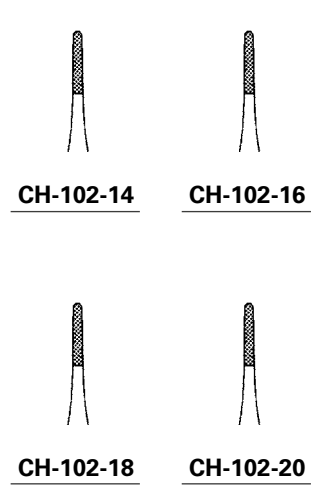

HEGAR-VASCULAR

| | |
|------------------|-----------------|
| CH-104-14 | 14,0 cm, 5 1/2" |
| CH-104-16 | 16,0 cm, 6 1/4" |
| CH-104-18 | 18,0 cm, 7" |
| CH-104-20 | 20,0 cm, 8" |
| CH-104-23 | 23,0 cm, 9" |

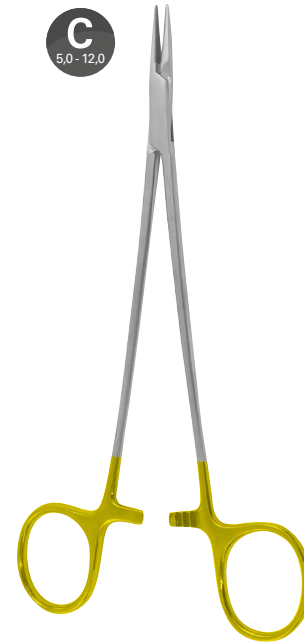
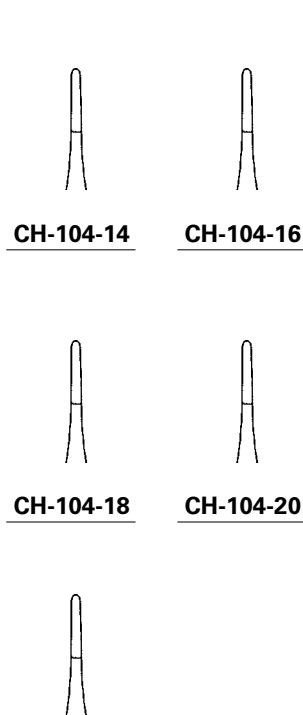

MICRO-VASCULAR

| | |
|------------------|-----------------|
| CH-106-14 | 14,0 cm, 5 1/2" |
| CH-106-18 | 18,0 cm, 7" |
| CH-106-20 | 20,0 cm, 8" |
| CH-106-23 | 23,0 cm, 9" |

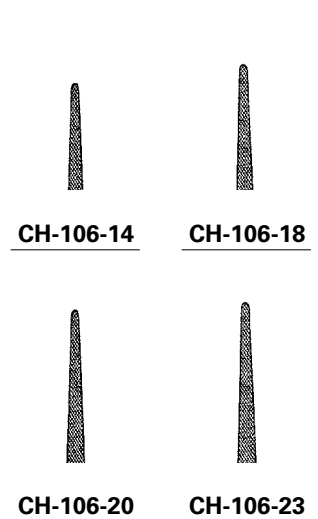

Needle Holders with Tungsten Carbide Inserts



B
4,0 - 6,0

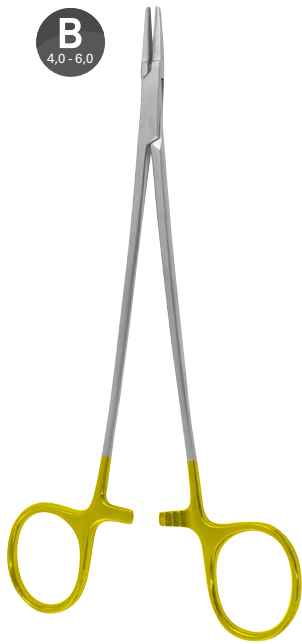

RYDER-VASCULAR

| | |
|------------------|---------------|
| CH-110-13 | 13,0 cm, 5" |
| CH-110-15 | 15,0 cm, 6" |
| CH-110-18 | 18,0 cm, 7" |
| CH-110-20 | 20,0 cm, 8" |
| CH-110-23 | 23,0 cm, 9" |
| CH-110-26 | 26,0 cm, 10½" |

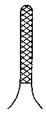

CH-110-13

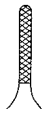

CH-110-15

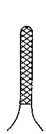

CH-110-18

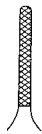

CH-110-20

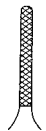

CH-110-23

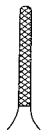

CH-110-26

C
5,0 - 12,0

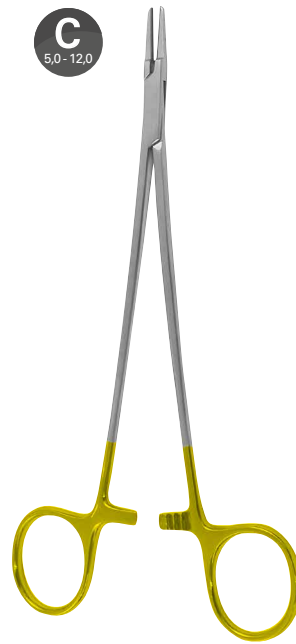

MICRO-RYDER

| | |
|------------------|---------------|
| CH-112-13 | 13,0 cm, 5" |
| CH-112-15 | 15,0 cm, 6" |
| CH-112-18 | 18,0 cm, 7" |
| CH-112-20 | 20,0 cm, 8" |
| CH-112-23 | 23,0 cm, 9" |
| CH-112-26 | 26,0 cm, 10½" |



CH-112-13

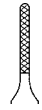

CH-112-15

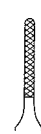

CH-112-18

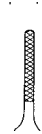

CH-112-20

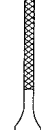

CH-112-23

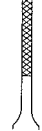

CH-112-26

C
5,0 - 12,0



DIETRICH-VASCULAR

| | |
|------------------|---------------|
| CH-116-16 | 16,0 cm, 6¼" |
| CH-116-18 | 18,0 cm, 7" |
| CH-116-20 | 20,0 cm, 8" |
| CH-116-23 | 23,0 cm, 9" |
| CH-116-26 | 26,0 cm, 10½" |



CH-116-16



CH-116-18



CH-116-20



CH-116-23



CH-116-26

Needle Holders with Tungsten Carbide Inserts



B
4,0 - 6,0

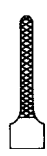

CH-120-14



CH-120-17

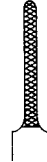

CH-120-20

B
4,0 - 6,0



CH-122-17



CH-122-20



CH-122-24

MATHIEU-RYDER

CH-120-14 14,0 cm, 5 ½"

CH-120-17 17,0 cm, 6 ¾"

CH-120-20 20,0 cm, 8"

MATHIEU-RYDER

CH-122-17 17,0 cm, 6 ¾"

CH-122-20 20,0 cm, 8"

CH-122-24 24,0 cm, 9 ½"

B
4,0 - 6,0



CH-130-20

LANGENBECK-RYDER

CH-130-20 20,0 cm, 8"

Suture Instruments



Ligature adjuster

CH-786-23 23,0 cm, 9"



Ligature catcher

MOD. VIENNA (WIEN)

CH-787-24 23,5 cm, 9 1/4"



CH-790-51 complete with one needle Fig.1 I



Fig. 1

CH-790-51



Fig. 2

CH-790-52



Fig. 3

CH-790-53

YOUNG-HRYNTSCHAK

CH-790-24 24,0 cm, 9 1/2"

Lip and Cheek Retractors, Tongue Holding Forceps



CAWOOD-MINNESOTA

CH-069-15 15,0 cm, 6"



STERNBERG

CH-070-12 12,0 cm, 4 3/4"

CH-070-14 14,0 cm, 5 1/2"

CH-070-16 16,0 cm, 6 1/4"



CH-071-19 19,0 cm, 7 1/2"



COLLIN

CH-072-16 16,0 cm, 6 1/4"

CH-072-18 18,0 cm, 7"



YOUNG

CH-073-16 16,0 cm, 6 1/4"

Spare rubber Inserts for CH-073-16

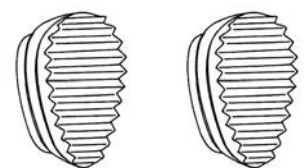

YOUNG

CH-073-99

Cheek Retractors, Finger Protector, Oral Screw



SIMPLEX

CH-074-11 10,5 cm, 4 ¼"

Fig. 1
CH-075-01

Fig. 2
CH-075-02

Set of 2

Fig. 3
CH-075-03



MC KESSON

CH-075-01 - CH-075-03

Oral screw, made of wood

Ø 32,0 mm



MAUNDER

CH-075-10 9,5 cm, 3 ¾"

Oral screw, made of silicone



PITHA

CH-076-10 28 x 30 mm



ADAMS

CH-077-00 28 x 30 mm



LANGENBECK

CH-079-01 Ø 17 - 21 mm

CH-079-02 Ø 19 - 24 mm

CH-079-03 Ø 21 - 26 mm

Septum Elevators



3,3 mm
CH-655-18

HALLE

CH-655-18 18,0 cm, 7 "



Ø 4,0 mm
CH-660-21

Suction elevator

FREER-GORNEY

CH-660-21 21,0 cm, 8 ¼ "

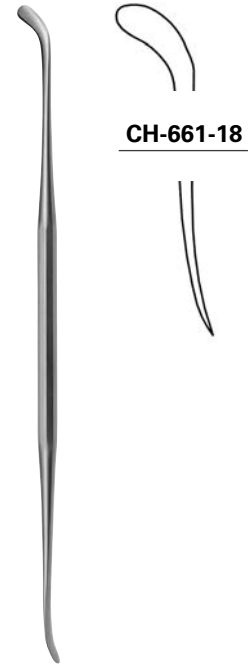

CH-661-18

FREER

CH-661-18 17,5 cm, 7 "

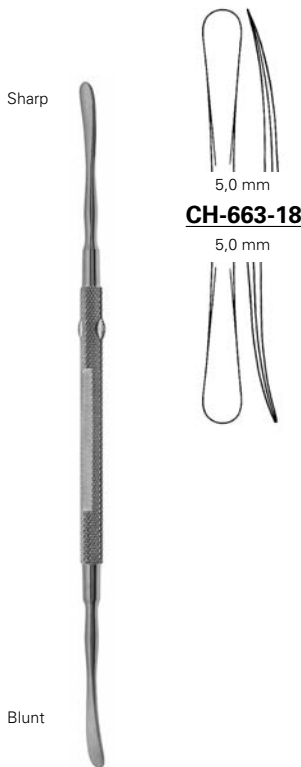

5,0 mm
CH-663-18
5,0 mm

Blunt

FREER

CH-663-18 18,0 cm, 7 "

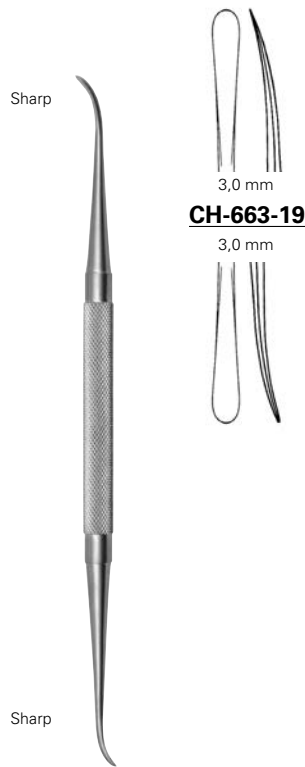

3,0 mm
CH-663-19
3,0 mm

Sharp

Sharp

FREER-YASARGIL

CH-663-19 18,5 cm, 7 ¼ "

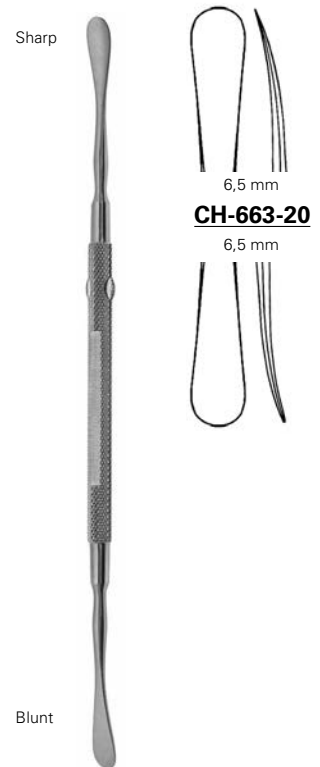

6,5 mm
CH-663-20
6,5 mm

Sharp

Blunt

FREER

CH-663-20 20,0 cm, 8 "

Septum Elevators



FREER-JOSEPH

CH-663-21 20,0 cm, 8"



FREER

CH-665-20 20,0 cm, 8"



6,0 mm

CH-665-20

5,0 mm



FREER

CH-668-19 19,0 cm, 7 1/2"



CH-668-19



CH-669-01



FREER

CH-669-01 19,0 cm, 7 1/2"



CH-669-02



FREER

CH-669-02 19,0 cm, 7 1/2"



CH-669-03

FREER

CH-669-03 19,0 cm, 7 1/2"

Septum Elevators



CH-670-17 17,0 cm, 6 ¾"



CH-672-21

PIERCE

CH-672-21 21,0 cm, 8 ¼"

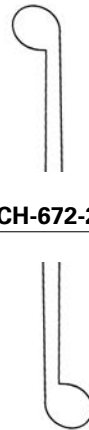

CH-673-21

PENNINGTON

CH-673-21 21,0 cm, 8 ¼"

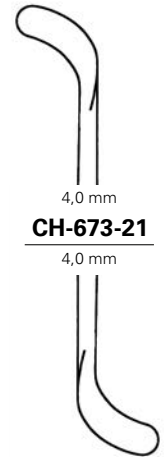

CH-675-19

ROGER

CH-675-19 19,0 cm, 7 ½"

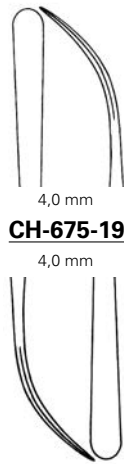

CH-678-19

MC KENTY

CH-678-19 19,0 cm, 7 ½"

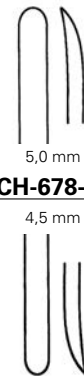

CH-679-20

BALLENGER-HAJEK

CH-679-20 19,0 cm, 7 ½"

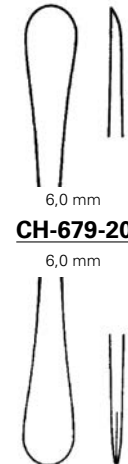

Septum Elevators



4,5 mm

CH-679-21

4,5 mm



COTTLE

CH-679-21 21,0 cm, 8 ¼"



3,3 mm

CH-681-21

3,7 mm

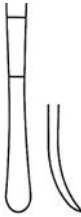

COTTLE

CH-681-21 21,0 cm, 8 ¼"



3,0 mm

CH-681-22

2,0 mm



MASING

CH-681-22 22,0 cm, 8 ¾"



3,0 mm

CH-683-03



5,0 mm

CH-683-05

MC KENTY

CH-683-03 - CH-683-05 15,0 cm, 6"



4,0 mm

CH-683-04

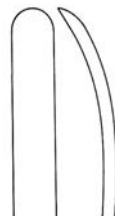

6,5 mm

CH-687-16



JOSEPH

CH-687-16 16,0 cm, 6 ¼"

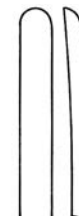

4,0 mm

CH-688-22



JOSEPH-MASING

CH-688-22 22,0 cm, 8 ¾"

Septum Elevators, Suction Raspatories



KILLIAN

CH-689-18 18,0 cm, 7"

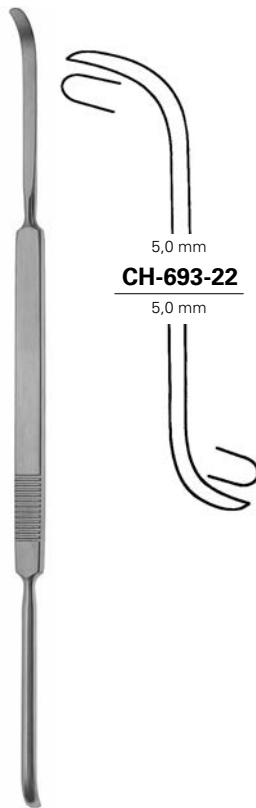

COTTLE

CH-693-22 23,0 cm, 9"



HOWARTH

CH-695-22 21,5 cm, 8 1/2"

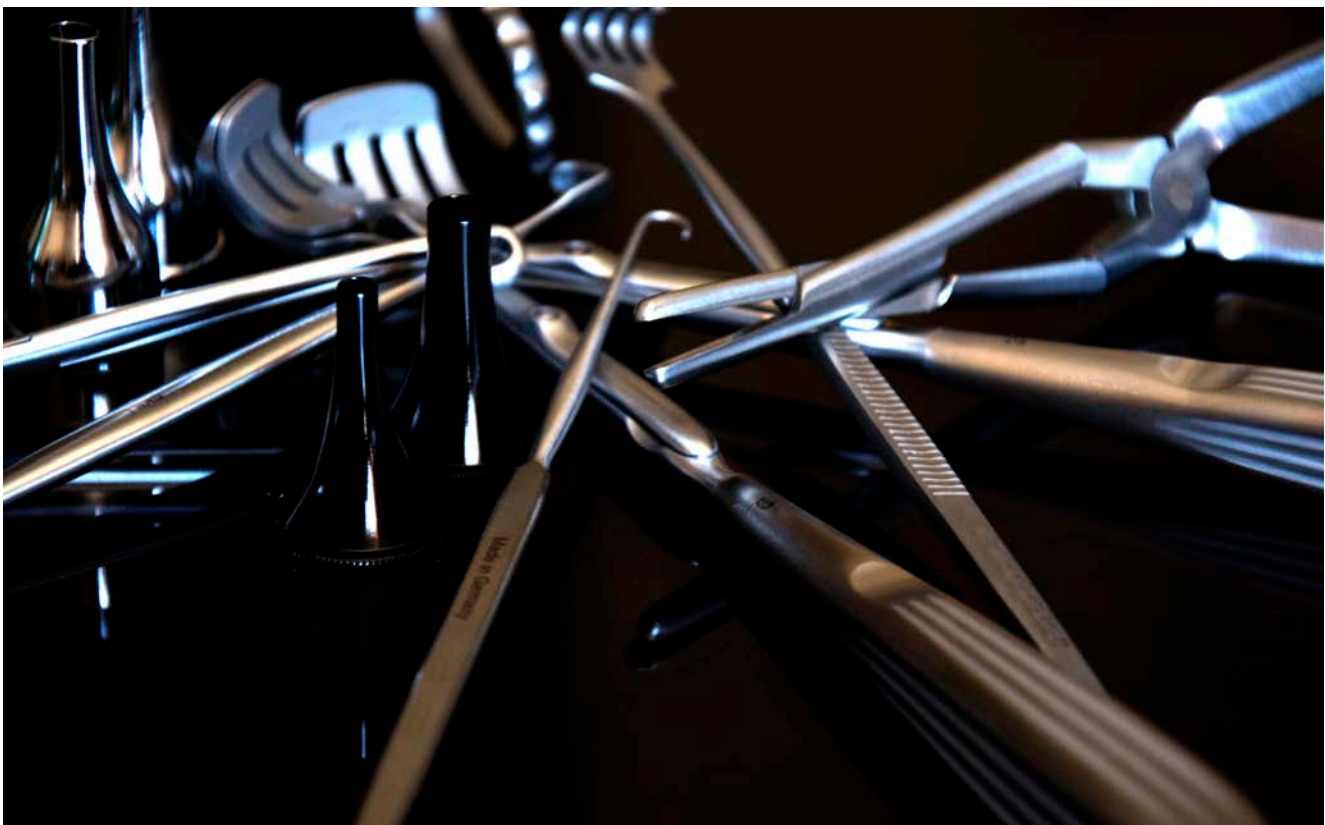

Mallets



HW Head weight

TW Total weight



HW 320 g
TW 420 g
Ø 26,0 mm

CH-200-22

Spare discs

MEAD

CH-200-20 19,0 cm, 7 ½ "



HW 140 g
TW 240 g
Ø 25,0 mm

CH-201-99

Spare discs

MEAD

CH-201-25 18,5 cm, 7 ¼ "



HW 220 g
TW 240 g
Ø 30,0 mm

CH-217-30

COLLIN

CH-217-30 20,0 cm, 8 "



HW 100 g
TW 140 g
Ø 20,0 mm

CH-203-22

CH-203-22 16,5 cm, 6 ½ "



HW 160 g
TW 220 g
Ø 22,0 mm

CH-204-22

Lead filled head

CH-204-22 19,0 cm, 7 ½ "



HW 160 g
TW 220 g
Ø 22,0 mm

CH-205-27

HAJEK

CH-205-27 20,0 cm, 8 "

Bone Currettes

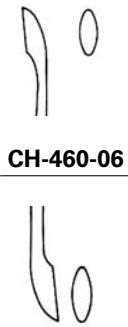

CH-460-06

BARTH

CH-460-06 18,0 cm, 7 "

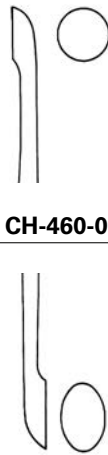

CH-460-07

CH-460-07 21,0 cm, 8 ¼ "

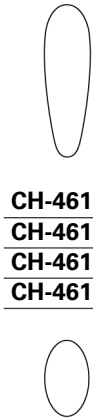

CH-461-01
CH-461-02
CH-461-03
CH-461-04

VOLKMANN

CH-461-01 13,0 cm, 5 ⅛ "
CH-461-02 14,0 cm, 5 ½ "
CH-461-03 17,0 cm, 6 ¾ "
CH-461-04 20,0 cm, 8 "



CH-462-01



CH-462-02



CH-462-03

VOLKMANN

CH-462-01 13,0 cm, 5 ⅛ "
CH-462-02 16,0 cm, 6 ¼ "
CH-462-03 20,0 cm, 8 "

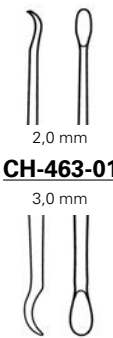

CH-463-01

MILLER

CH-463-01 18,0 cm, 7 "

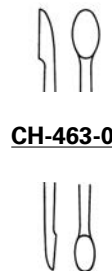

CH-463-02

JANSEN

CH-463-02 16,0 cm, 6 ¼ "

Raspatories

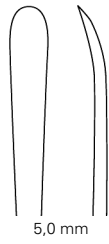

CH-353-15
Raspatory

KOENIG

CH-353-15 15,5 cm, 6 1/8"



CH-354-15
Raspatory

TRELAT

CH-354-15 15,0 cm, 6"



CH-355-14
Raspatory

WILLIGER

CH-355-14 13,0 cm, 5 1/8"



CH-355-15
Raspatory



CH-355-16
Raspatory



CH-355-17
Raspatory

WILLIGER

CH-355-15 - CH-355-17 16,0 cm, 6 1/4"



CH-356-17
Raspatory

JOSEPH

CH-356-17 17,0 cm, 6 3/4"

Raspatories, Elevators

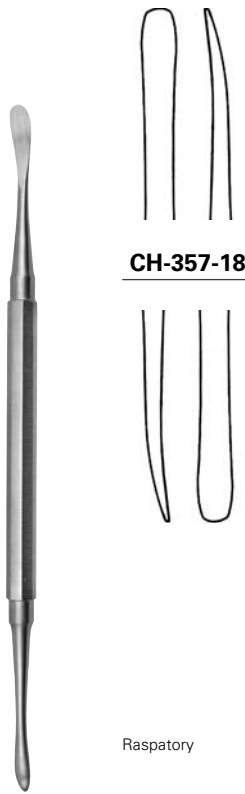

CH-357-18

Raspatory

MOLT

CH-357-18 18,0 cm, 7"



CH-358-19

Blunt

Elevator

FREER

CH-358-19 19,0 cm, 7 1/2"



CH-359-19

Sharp

Elevator

FREER

CH-359-19 19,0 cm, 7 1/2"



CH-361-16

Raspatory

WULLSTEIN

CH-361-16 16,0 cm, 6 1/4"



CH-361-17

Raspatory

WULLSTEIN

CH-361-17 16,0 cm, 6 1/4"



CH-362-16

Raspatory

LEMPERT

CH-362-16 16,0 cm, 6 1/4"



CH-362-19

Raspatory

LEMPERT

CH-362-19 16,0 cm, 6 1/4"

Raspatories, Elevators

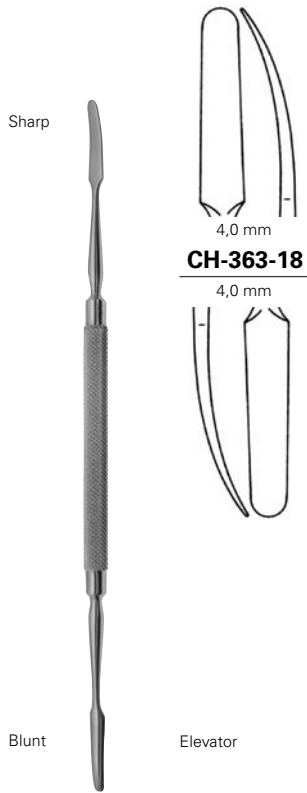

KILLIAN
CH-363-18 18,0 cm, 7"

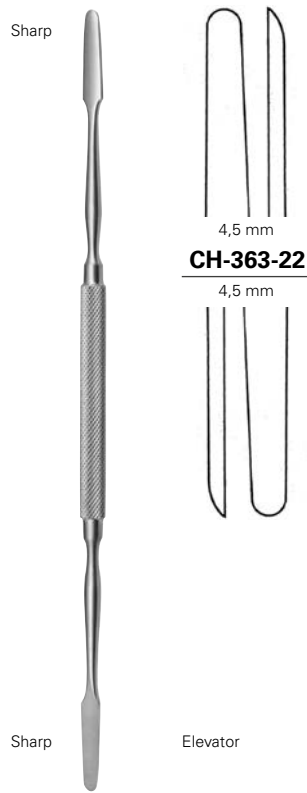

KILLIAN
CH-363-22 22,0 cm, 8 3/4"

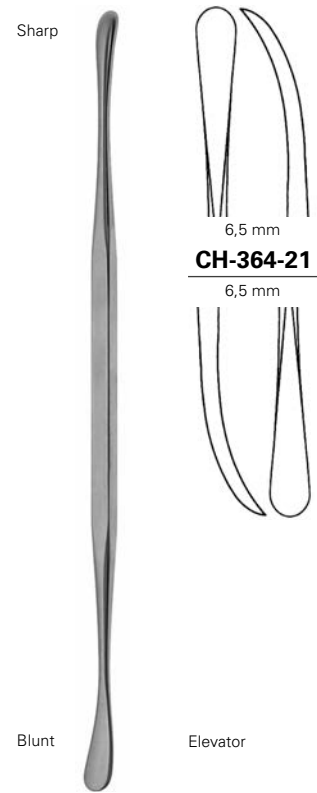

ADLERDYCE
CH-364-21 21,0 cm, 8 1/4"

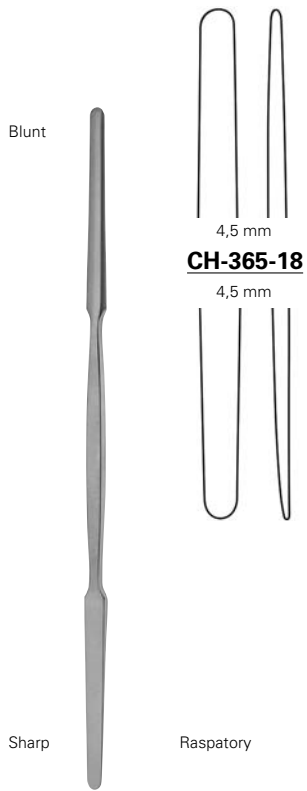

KILLIAN
CH-365-18 18,0 cm, 7"

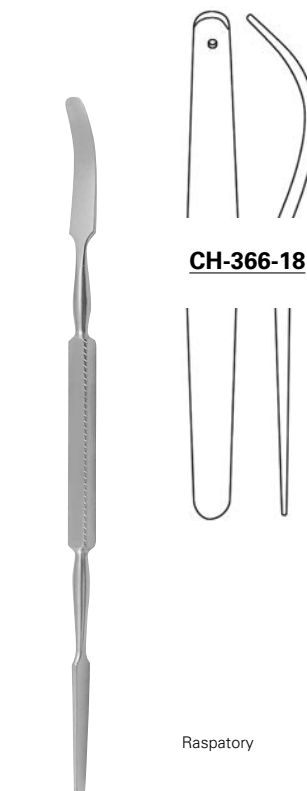

MC DONALD
CH-366-18 18,5 cm, 7 1/4"

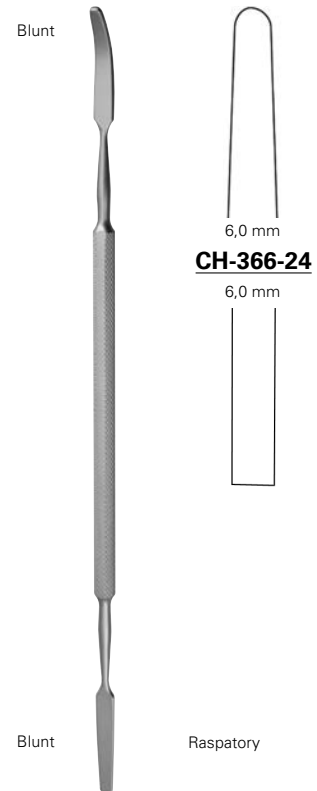

COHEN
CH-366-24 24,0 cm, 9 1/2"

Elevators, Dissectors

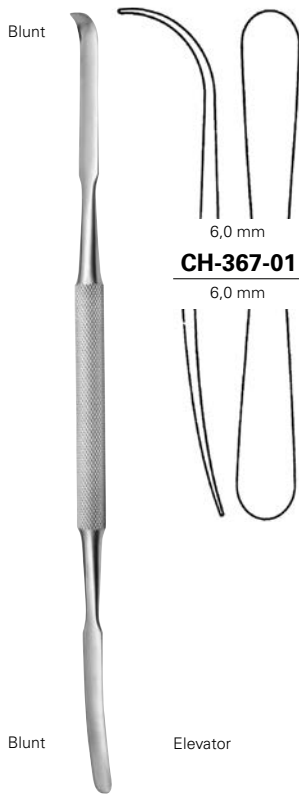

OBWEGESER

CH-367-01 21,0 cm, 8 ¼"

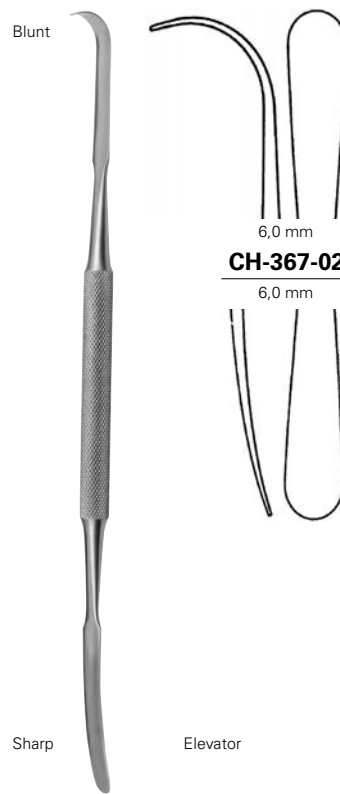

OBWEGESER

CH-367-02 21,0 cm, 8 ¼"



WATSON-CHEYNE

CH-371-13 13,0 cm, 5 ⅛"

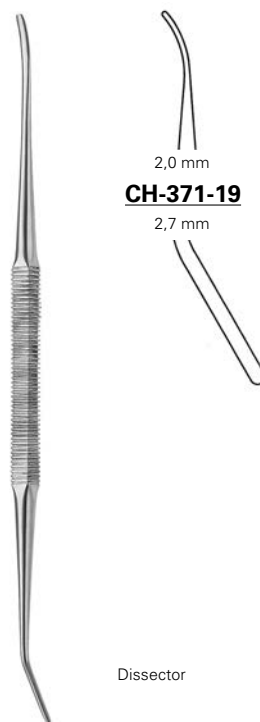

WATSON-CHEYNE

CH-371-19 19,0 cm, 7 ½"



WATSON-CHEYNE

CH-372-17 17,0 cm, 6 ¾"

Raspatories

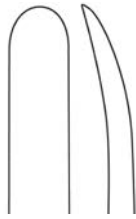

CH-379-06 6,0 mm
CH-379-08 8,0 mm



CH-377-05 5,0 mm
CH-377-07 7,0 mm
CH-377-09 9,0 mm

OBWEGESER

CH-379-06 - CH-379-08 17,0 cm, 6 3/4"

CH-377-05 - CH-377-09 20,5 cm, 8"

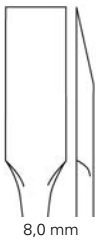

CH-380-01



CH-380-02



CH-380-03



CH-380-04

ADSON

CH-380-01 - CH-380-04 17,0 cm, 6 3/4"

Raspatories

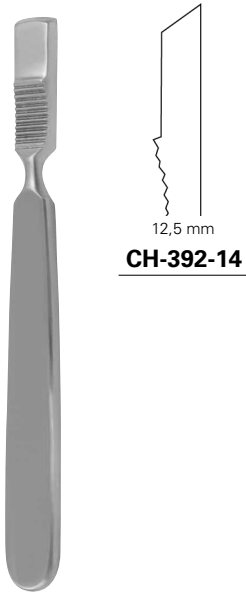

CH-392-14

FARABEUF

CH-392-14 15,0 cm, 6"

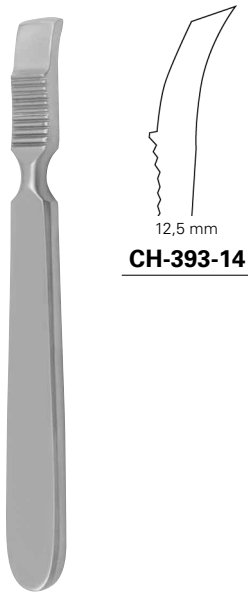

CH-393-14

FARABEUF

CH-393-14 15,0 cm, 6"

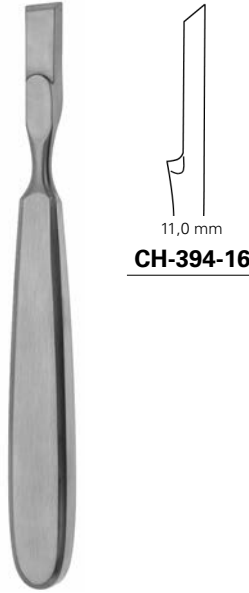

CH-394-16

FARABEUF-COLLIN

CH-394-16 16,0 cm, 6 3/4"

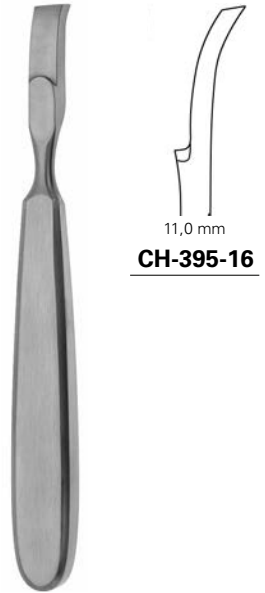

CH-395-16

FARABEUF-COLLIN

CH-395-16 16,0 cm, 6 3/4"



CH-396-18

SEDILLOT

CH-396-18 18,5 cm, 7 1/4"



CH-397-01

KRAEMER

CH-397-01 18,5 cm, 7 1/4"

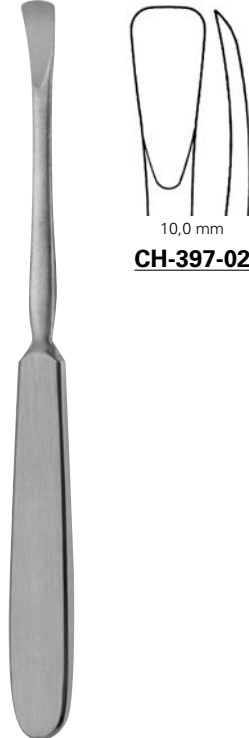

CH-397-02

KRAEMER

CH-397-02 19,0 cm, 7 1/2"

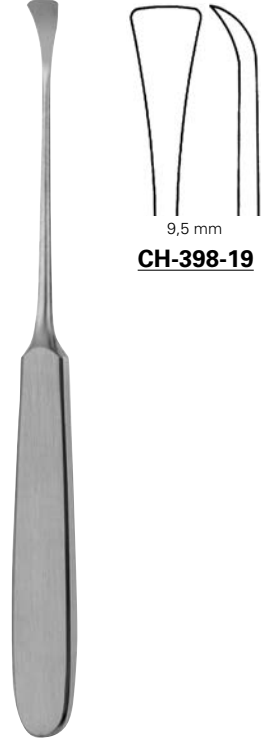

CH-398-19

BUECHS

CH-398-19 19,0 cm, 7 1/2"

Raspatories

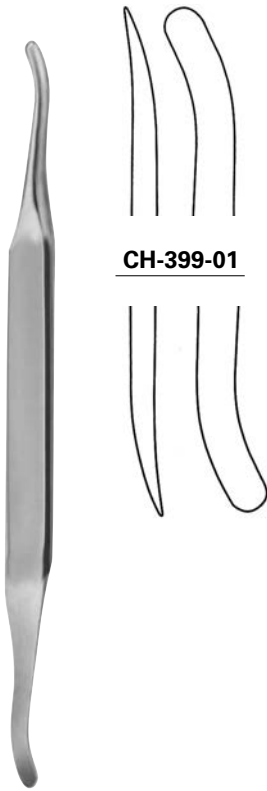

CH-399-01

SELDIN

CH-399-01 19,5 cm, 7 ¾ "

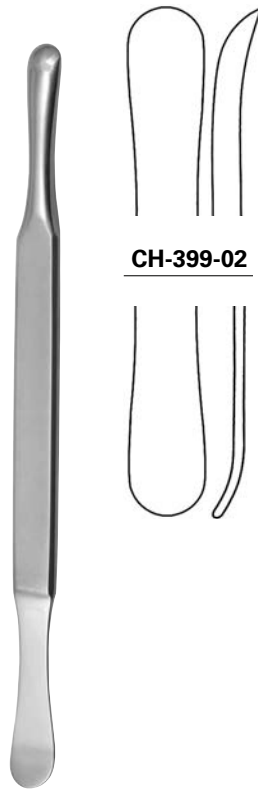

CH-399-02

SELDIN

CH-399-02 19,5 cm, 7 ¾ "



CH-400-16

JANSEN

CH-400-16 16,5 cm, 6 ½ "



CH-401-01

LANGENBECK

CH-401-01 18,0 cm, 7 "



CH-401-02

LANGENBECK

CH-401-02 19,0 cm, 7 ½ "



CH-402-01

SCHNEIDER

CH-402-01 17,5 cm, 7 "

Raspatories

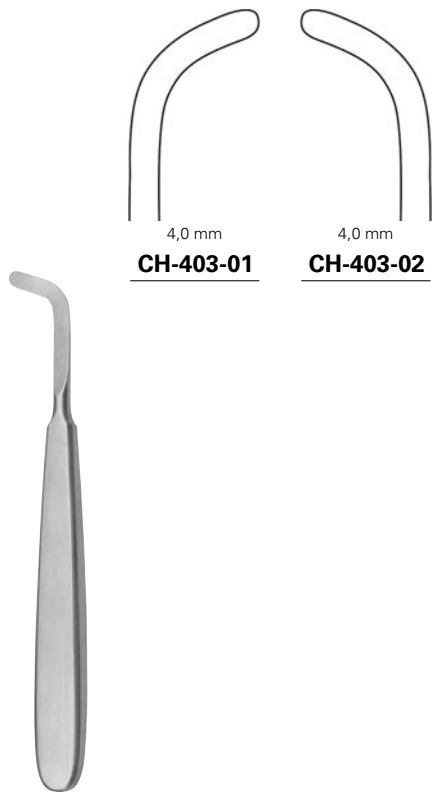

4,0 mm
CH-403-01

4,0 mm
CH-403-02

CH-403-01 - CH-403-02 14,0 cm, 5 ½"



CH-405-05 5,0 mm
CH-405-10 10,0 mm
CH-405-15 15,0 mm
CH-405-20 20,0 mm
CH-405-25 25,0 mm

LAMBOTTE

CH-405-05 - CH-405-25 21,0 cm, 8 ¼"



14,0 mm
CH-402-02

SCHNEIDER-SAUERBRUCH

CH-402-02 19,0 cm, 7 ½"

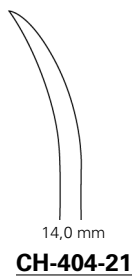

14,0 mm
CH-404-21

SEDILLOT

CH-404-21 21,0 cm, 8 ¼"

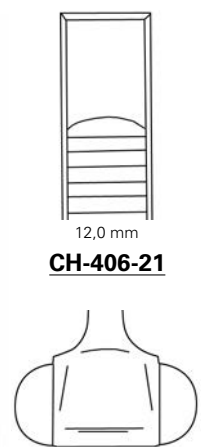

12,0 mm
CH-406-21

ALEXANDER

CH-406-21 21,0 cm, 8 ¼"

Rongeurs



CH-603-14



KLEINERT-KUTZ

CH-603-14 14,0 cm, 5 1/2"



CH-604-01



HEANLEY

CH-604-01 18,0 cm, 7"



CH-605-01

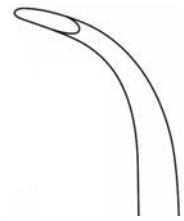

CH-605-02



STELLBRINK

CH-605-01 17,5 cm, 8"
CH-605-02 16,5 cm, 6 1/2"



CH-607-12



FRIEDMANN-MINI

CH-607-12 12,5 cm, 5"



CH-607-14



LUER-FRIEDMANN

CH-607-14 14,5 cm, 5 3/4"



CH-608-14

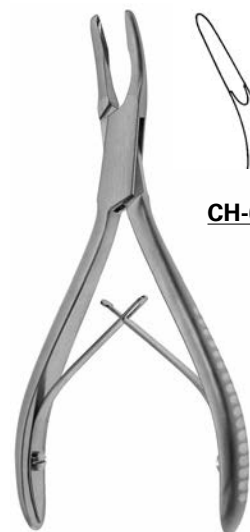

FRIEDMANN-VICKERS

CH-608-14 14,0 cm, 5 1/2"

Rongeurs

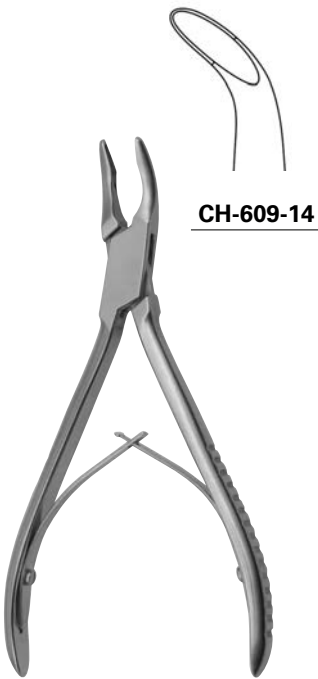

CH-609-14

CH-609-14 14,0 cm, 5 1/2"

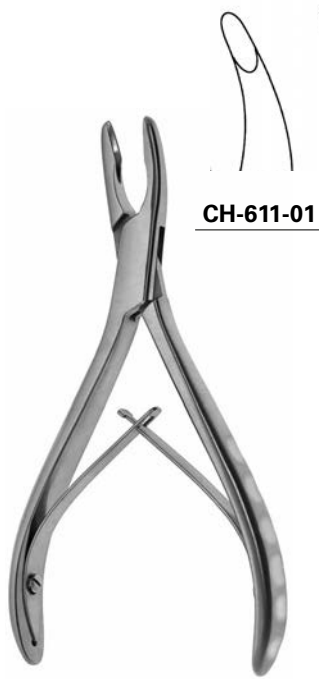

CH-611-01

LUER

CH-611-01 - CH-611-03 15,0 cm, 6"

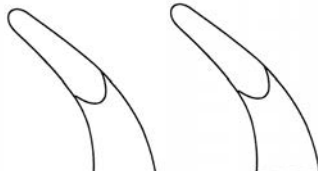

CH-611-02

CH-611-03

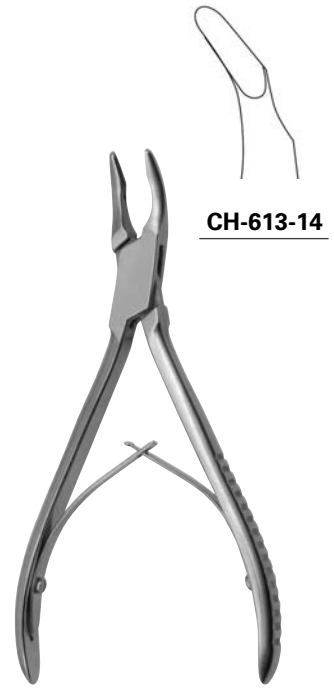

CH-613-14

CLEVELAND

CH-613-14 14,0 cm, 5 1/2"



CH-613-17

CLEVELAND

40-613-17 17,0 cm, 6 3/4"



CH-615-01

BLUMENTHAL

CH-615-01 - CH-615-03 15,5 cm, 6 1/8"

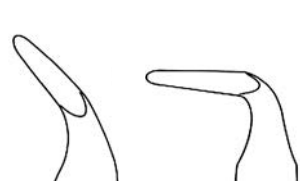

CH-615-02

CH-615-03



CH-616-17

HAKANSSON

40-616-17 17,0 cm, 6 3/4"

Rongeurs



CH-617-16



CH-617-17



CH-618-17



CH-617-19

JANSEN

CH-617-16 - CH-618-17 17,5 cm, 6 ¾ "

JANSEN

CH-617-19 19,0 cm, 7 ½ "



CH-619-17



CH-621-19

HARTMANN

CH-619-17 17,0 cm, 6 ¾ "

BACON

CH-621-19 19,5 cm, 7 ¾ "

Rongeurs



CH-622-16
CH-622-20



CH-623-16
CH-623-20



CH-625-18

LEMPERT

CH-622-16 - CH-623-16 16,0 cm, 6 ¼"
CH-622-20 - CH-623-20 20,0 cm, 8"

BEYER

CH-625-18 18,0 cm, 7"



CH-627-01



CH-627-02



CH-628-17



CH-629-17

MEAD

CH-627-01 - CH-627-02 16,5 cm, 6 ½"

LUER

CH-628-17 - CH-629-17 17,5 cm, 7"

Rongeurs

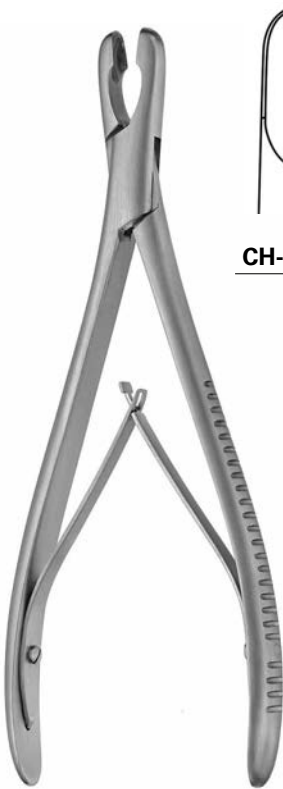

CH-630-20



CH-631-20

ADSON

CH-630-20 - CH-631-20 20,0 cm, 8 "



CH-632-20

PENNYBACKER

CH-632-20 20,5 cm, 8 "



CH-633-20

OLIVECRONA

CH-633-20 20,0 cm, 8 "



CH-635-20

GULEKE

CH-635-20 20,5 cm, 8 "

Rongeurs



| | |
|------------------|--------|
| CH-640-02 | 2,0 mm |
| CH-640-03 | 3,0 mm |
| CH-640-04 | 4,0 mm |
| CH-640-05 | 5,0 mm |

| | |
|------------------|--------|
| CH-641-02 | 2,0 mm |
| CH-641-03 | 3,0 mm |
| CH-641-04 | 4,0 mm |
| CH-641-05 | 5,0 mm |



CH-641-15

BOEHLER

CH-640-02 - CH-641-05 15,5 cm, 6 1/8"

BOEHLER

CH-641-15 15,5 cm, 6 1/8"



CH-643-01



CH-643-02

KLEINERT-KUTZ

CH-643-01 - CH-643-02 14,0 cm, 5 1/2"



CH-645-17

MAYFIELD

CH-645-17 18,0 cm, 7"

Rongeurs



CH-647-20

MARQUARDT

CH-647-20 20,0 cm, 8"



CH-649-18

BEYER

CH-649-18 18,0 cm, 7"



CH-651-18

ZAUFAL-JANSEN

CH-651-18 18,0 cm, 7"



| | |
|------------------|--------|
| CH-652-04 | 4,0 mm |
| CH-652-05 | 5,0 mm |
| CH-652-06 | 6,0 mm |
| CH-652-07 | 7,0 mm |

| | |
|------------------|--------|
| CH-653-04 | 4,0 mm |
| CH-653-05 | 5,0 mm |
| CH-653-06 | 6,0 mm |
| CH-653-07 | 7,0 mm |

RUSKIN

CH-652-04 - 40-653-07 18,0 cm, 7"

Bone Cutting Forceps



CH-701-15

CLEVELAND
CH-701-15 15,0 cm, 6"

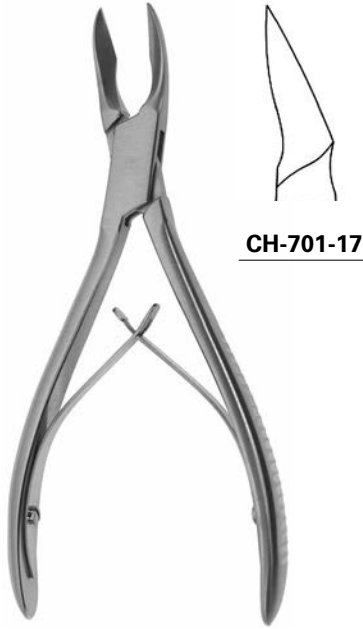

CH-701-17

CLEVELAND
CH-701-17 17,0 cm, 6 3/4"

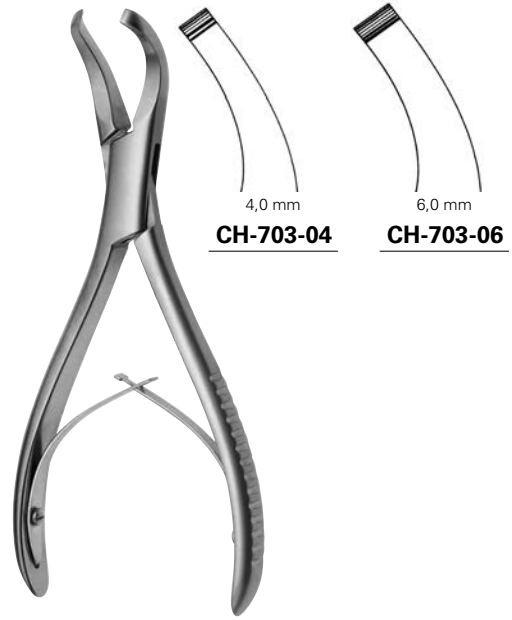

4,0 mm
CH-703-04

6,0 mm
CH-703-06

GARDNER
CH-703-04 - CH-703-06 16,0 cm, 6 1/4"



CH-704-19

COTTLE-KAZANJIAN
CH-704-19 19,0 cm, 7 1/4"



LISTON

CH-706-14 - CH-707-14 14,0 cm, 5 1/2"
CH-706-17 - CH-707-17 17,0 cm, 6 3/4"
CH-706-20 - CH-707-19 20,0 cm, 8"
CH-706-22 - CH-707-22 22,0 cm, 8 3/4"

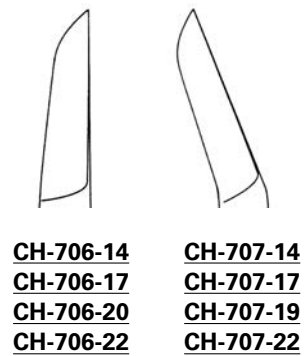

CH-706-14
CH-706-17
CH-706-20
CH-706-22

CH-707-14
CH-707-17
CH-707-19
CH-707-22

Bone Cutting Forceps

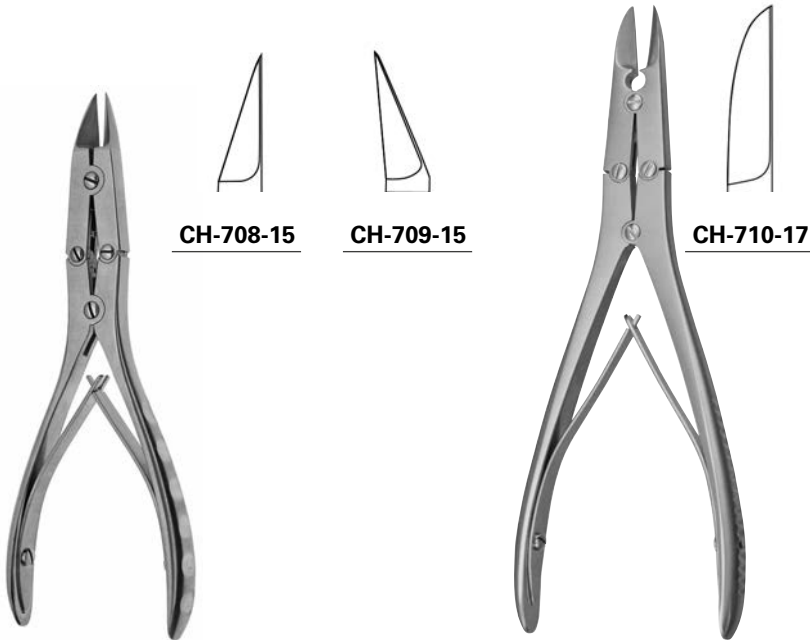

BOEHLER

CH-708-15 - CH-709-15 14,5 cm, 5 3/4"

CH-710-17 17,0 cm, 6 3/4"

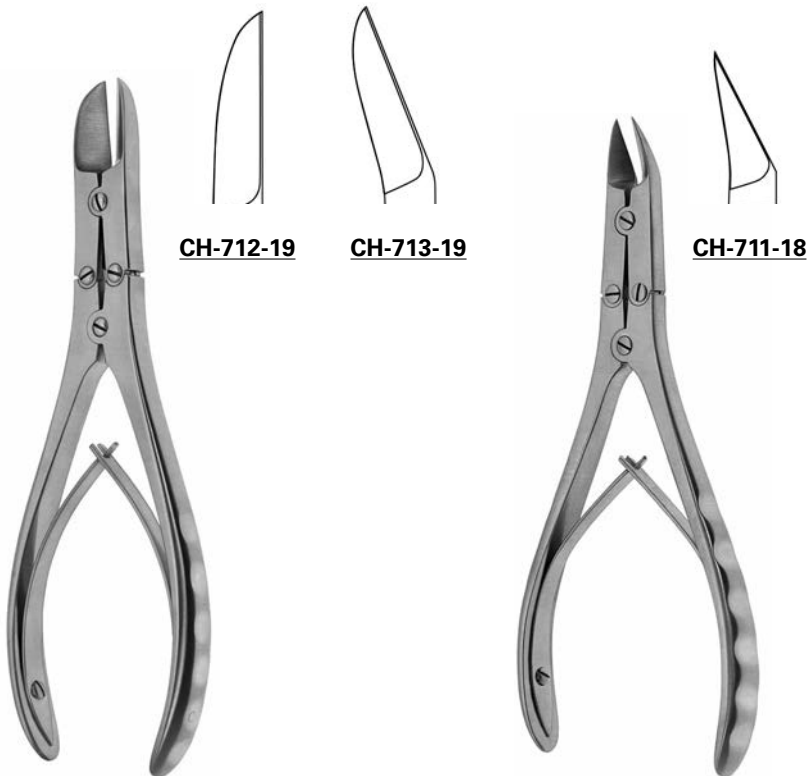

RUSKIN-LISTON

CH-712-19 - CH-713-19 19,0 cm, 7 1/2"

MC INDOE

CH-711-18 17,5 cm, 7"



LISTON

CH-715-24 24,0 cm, 9 1/2"

Stainless Steel Holloware



Kidney dishes



| | |
|------------------|-------------------|
| CH-100-17 | 170 x 100 x 35 mm |
| CH-100-25 | 250 x 140 x 40 mm |
| CH-100-27 | 270 x 150 x 45 mm |

Round bowls



| | | |
|------------------|--------------|---------|
| CH-101-14 | 140 x 55 mm | 0,50 l |
| CH-101-16 | 150 x 75 mm | 0,75 l |
| CH-101-17 | 160 x 75 mm | 1,00 l |
| CH-101-22 | 220 x 75 mm | 2,00 l |
| CH-101-23 | 225 x 90 mm | 2,50 l |
| CH-101-24 | 240 x 95 mm | 3,00 l |
| CH-101-25 | 255 x 115 mm | 3,50 l |
| CH-101-27 | 260 x 120 mm | 4,50 l |
| CH-101-29 | 290 x 125 mm | 6,00 l |
| CH-101-31 | 300 x 115 mm | 6,00 l |
| CH-101-34 | 320 x 140 mm | 8,50 l |
| CH-101-38 | 380 x 130 mm | 11,00 l |
| CH-101-41 | 400 x 155 mm | 14,00 l |

Round bowls



| | | |
|------------------|---------------|--------|
| CH-103-04 | Ø 40 x 19 mm | 0,05 l |
| CH-103-06 | Ø 61 x 30 mm | 0,07 l |
| CH-103-08 | Ø 80 x 40 mm | 0,14 l |
| CH-103-11 | Ø 116 x 50 mm | 0,35 l |
| CH-103-12 | Ø 128 x 55 mm | 0,45 l |
| CH-103-14 | Ø 147 x 65 mm | 0,70 l |
| CH-103-16 | Ø 210 x 90 mm | 2,50 l |

Round bowls



| | | |
|------------------|---------------|--------|
| CH-105-11 | Ø 116 x 35 mm | 0,30 l |
| CH-105-12 | Ø 128 x 38 mm | 0,40 l |
| CH-105-14 | Ø 147 x 40 mm | 0,50 l |
| CH-105-15 | Ø 157 x 45 mm | 0,75 l |
| CH-105-18 | Ø 187 x 45 mm | 1,00 l |

Solution bowls



| | | |
|------------------|--------------|--------|
| CH-106-04 | Ø 50 x 45 mm | 0,05 l |
| CH-106-05 | Ø 60 x 52 mm | 0,07 l |

Solution bowls



| | | |
|------------------|---------------|--------|
| CH-106-10 | Ø 75 x 103 mm | 0,25 l |
|------------------|---------------|--------|

Stainless Steel Holloware



Medicine spoon, graduated inside

- CH-107-01** Ø 30 x 90 mm
- CH-107-02** Ø 50 x 100 mm
- CH-107-03** Ø 50 x 130 mm
- CH-107-04** Ø 50 x 175 mm
- CH-107-05** Ø 75 x 100 mm
- CH-107-06** Ø 75 x 130 mm
- CH-107-07** Ø 75 x 175 mm
- CH-107-08** Ø 85 x 175 mm
- CH-107-09** Ø 95 x 200 mm



CH-109-00 110 x 30 mm 12,5 ml



Medicine cup, graduated inside

51-109-01 50 x 25 mm 25,0 ml

Measuring cup, graduated inside

Medicine cup, graduated inside



CH-109-02 Ø 53 x 45 mm 50,0 ml



- CH-109-03** 0,25 l
- CH-109-04** 0,50 l
- CH-109-05** 1,00 l
- CH-109-06** 2,00 l

Measuring cup, graduated inside



CH-110-00 100,0 ml

Stainless Steel Holloware



Dish, lid with knob



- CH-111-01** Ø 75 x 60 mm

- CH-111-02** Ø 75 x 75 mm

- CH-111-03** Ø 100 x 60 mm

- CH-111-04** Ø 100 x 100 mm

- CH-111-05** Ø 125 x 80 mm

- CH-111-06** Ø 125 x 125 mm

- CH-111-07** Ø 150 x 150 mm

Sputum cup



CH-112-09 Ø 75 x 75 mm 0,30 l

Metal cup



51-112-90 Ø 90 x 90 mm

Round bowl



CH-113-15 Ø 110 x 28 mm 0,15 l

Petri dish



51-116-00 SET

Dish, only

CH-116-01 Ø 96 x 20 mm

Lid, only

51-116-02 Ø 100 x 20 mm



Operate with



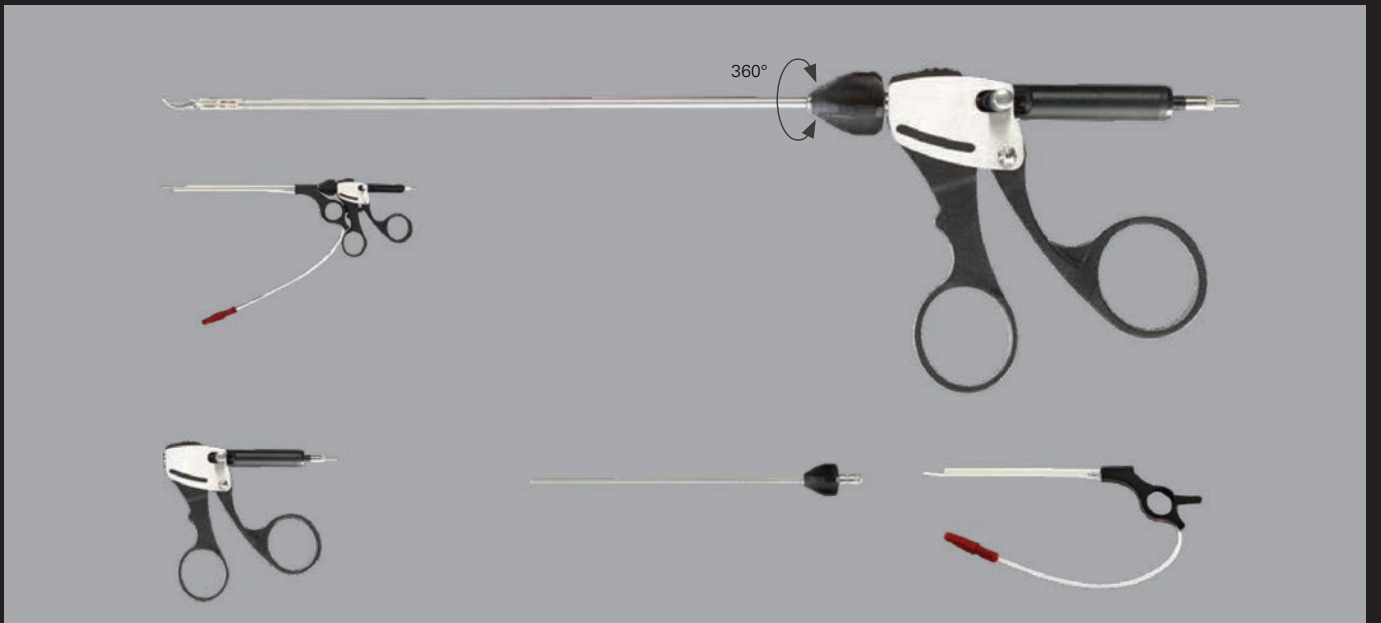

Authorised Dealer / Agent

www.skillinstruments.co.za

SKILL® Surgical Instruments
Rottweiler Street 53
D-78669 Wellendingen
Germany